

THE CASH BOX

THE
CONFIDENTIAL WEEKLY
OF THE
COIN MACHINE INDUSTRY

Vol. 7, No. 29
WEEK OF
APRIL 1, 1946

IT NEEDED DOING..



SO WURLITZER DID IT!

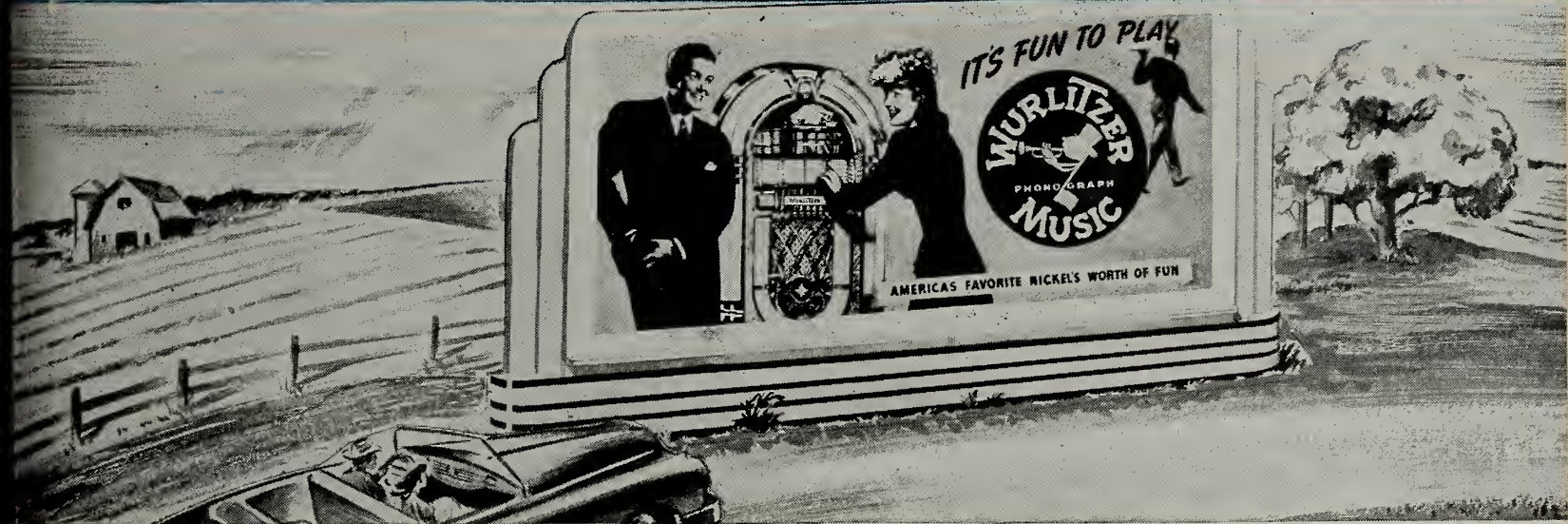

Every Wurlitzer Factory-Approved Music Merchant and Location Owner Will Share the Tremendous Benefits

The commercial phonograph business needed better public relations. Needed someone to serve up the story of commercial phonograph music for the clean, wholesome entertainment it is. Needed someone with the foresight and the finances to launch a national advertising program to the American people. In their greatest national magazines. On the billboards that dot their highways. By signs in locations. A Triple-Action campaign that would picture and dramatize the commercial phonograph as a definite contribution to the American way of life.

Wurlitzer's "Triple Action"
Advertising Campaign
will reach Everybody...Everywhere



Wurlitzer is doing it today. With full color, full page ads in the SATURDAY EVENING POST, COLLIER'S, LOOK and LIBERTY. With colorful billboards from coast to coast. Telling everyone everywhere to look for the *Sign of the Musical Note* where they'll find . . . "America's Favorite Nickel's Worth of Fun". Already it has proved worth the doing. Already Wurlitzer Factory-Approved Music Merchants and Wurlitzer Location Owners are pocketing the rewards. The Rudolph Wurlitzer* Company, North Tonawanda, New York.

*The Name That Means Music to Millions.

WATCH WURLITZER EXTEND ITS LEADERSHIP



**"CHATS WITH
DOC"**



No. 6. Simplicity

"The mechanism in the A.M.I. Phonograph is the finest expression of engineered simplicity ever offered to operators. It's amazingly light in weight, overpoweringly rugged, small

and compact. It turns each record at the will of the player and does everything you ever hoped a phonograph mechanism might do."

DeWitt (Doc) Eaton, Automatic Instrument Co.

Veterans and Coin Machines

By Bill Gersh



"COINTOONS"

Some months ago *The Cash Box* urged all coinmen to welcome the returning veteran to this industry.

This recommendation was made on the premise that not only would the vets bring the kind of new blood to this business which was necessary for its future growth and better welfare, but that because of their youth—they would also bring with them a new and younger outlook for the future and would enter into the use of the new equipment with greater optimism and daring.

Today, in the city of Detroit, long established coinmen are thankful that the vets entered in such numbers into the coin machine industry. It was the veterans who appealed in person to Michigan's Liquor Control Commission and halted the removal of all types of coin operated amusement machines from locations licensed to sell beer, wine and liquor.

It is these men upon whom all Michigan's coinmen pin their hopes to win a favorable verdict for them with the Liquor Control Commission when the three commissioners again meet and come to a final decision regarding allowing coin operated amusement devices to continue in liquor selling locations.

In Washington, General Omar S. Bradley, Chief of the Veterans' Administration, called in one noted coinman of that city and suggested the use of veterans for rehabilitation backed by the U. S. Government in a regular "school for mechanics" plan of one full year's duration.

After this full year's training in the mechanics of coin operated equipment the veteran would be graduated and receive a regular certificate regarding the fact that he had established himself as an expert coin machine mechanic.

Once again, then, the veterans are opening the way

to greater profits for the members of this industry by bringing to coinmen experienced mechanical help.

The only sad note which has so far entered into the picture of veterans returning to enter into the coin machine industry, has been the news from Seattle regarding the fact that sharpshooter vending machine salesmen are again at work mulcting many veterans there. These salesmen are selling vending machines on the old high pressure basis. This has stirred the Seattle Better Business Bureau to high indignation and has created somewhat of a furore in the Seattle press.

Again, *The Cash Box* hopes the coin machine field will hug the returning veteran to its bosom and will arrange to help and protect him as he enters into this business so that he will become one of the leading lights to gain for this industry the recognition it has so long deserved.

THE CASH BOX

"THE CONFIDENTIAL WEEKLY OF
THE COIN MACHINE INDUSTRY"

ISSUED EVERY WEEK BY SUBSCRIPTION ONLY
REPRODUCTION IN WHOLE OR IN PART FORBIDDEN
WITHOUT WRITTEN PERMISSION FROM THE
PUBLISHERS. COMPLETE CONTENTS COPYRIGHTED.

PUBLICATION OFFICES

381 FOURTH AVENUE, NEW YORK 16, NEW YORK
ALL PHONES: MURRAY HILL 4-7797

CHICAGO OFFICE

32 W. RANDOLPH ST., CHICAGO 1, ILLINOIS
HELEN PALMER, Mgr. ALL PHONES: DEARBORN 0045

LOS ANGELES OFFICE

422 W 11th ST, LOS ANGELES 15, CALIFORNIA
MARSHALL MICON Mgr. ALL PHONES: PERSPECT 2687

1880

1881

1882

1883

1884

1885

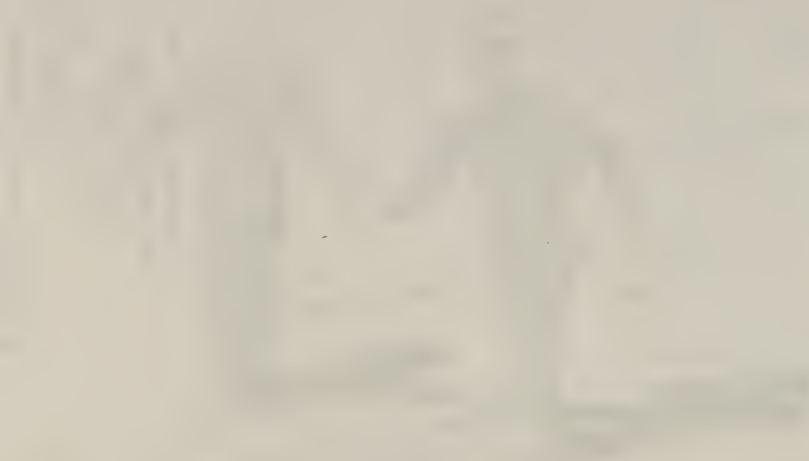

1886

NEW METHOD

THE ONLY METHOD

FOR THE

REMOVAL OF

SPOTS AND

DISCOLORATIONS

FROM

WASHING MACHINES

AND

LAUNDRIES

BY THE

USE OF

THIS

NEW

METHOD

THE

ONLY

ONE

THAT

IS

GUARANTEED

TO

RESTORE

THE

ORIGINAL

COLOR

AND

BRIGHTNESS

OF

THE

TEXTILES

AND

TO

PREVENT

THE

RE-APPEARANCE

OF

SPOTS

AND

DISCOLORATIONS

FOR

SALE

BY

ALL

GOOD

DEALERS

IN

HOUSEHOLD

ARTICLES

AND

BY

THE

MANUFACTURERS

OF

THIS

NEW

METHOD

FOR

THE

REMOVAL

OF

SPOTS

AND

DISCOLORATIONS

FROM

WASHING

MACHINES

AND

LAUNDRIES

BY

THE

USE

OF

THIS

NEW

METHOD

THE

ONLY

ONE

THAT

IS

GUARANTEED

TO

RESTORE

THE

ORIGINAL

COLOR

AND

BRIGHTNESS

OF

THE

TEXTILES

AND

TO

PREVENT

THE

RE-APPEARANCE

OF

SPOTS

AND

DISCOLORATIONS

FOR

SALE

BY

ALL

GOOD

DEALERS

IN

HOUSEHOLD

ARTICLES

AND

BY

THE

MANUFACTURERS

OF

THIS

NEW

METHOD

OPS AGREE

70% - 30%

IS THE ANSWER

NEW YORK — Slowly but surely, thruout the country, coinmen are beginning to adopt the urgent suggestion of *The Cash Box* and are forming themselves together into organizations in an effort to obtain 70 per cent commission from their locations.

The formation of the bonafide coin machine operators in the state of Alabama, as reported this past week, was solely for the purpose of obtaining a 70%-30% commission basis on all equipment now operating in that state. And the major machines operating there are juke boxes.

In Southern California the juke box association has arranged for a general vote as to whether all operators agree that they, too, should obtain 70 per cent commission from their locations, in keeping with the singular effort made in this direction by their vice-president.

In Western Michigan, eleven noted coinmen came together sometime ago and decided that they should eventually arrange to obtain 70 per cent commission. They increased their commissions obtained from locations to 60 percent during the war. They are now getting ready to obtain 70 per cent and hope eventually, to get 75% of the collections. These men realize what the beer shortage means. They endured two bad summers because of lack of beer with many of these ops finding their locations closed down for weeks at a stretch.

In Savannah, Ga. due to the efforts of a few large operators, the 70% commission basis has been put into practice. To accomplish this these larger music ops were actually forced to buy up routes of recalcitrants. They report a better average today than ever before.

Other territories, too, thruout the nation are gradually adopting *The Cash Box* suggestion which is now over three years old and which this publication has continued to drive home to the coin machine operator for it feels that to continue this as a great and successful industry its base — the operators — must be strong financially.

This is not the time, with an inflationary price boom under way raising all overhead costs, to continue to operate on the lax basis which the juke box trade has operated on for some time now.

The juke box operator cannot continue on a 50%-50% commission basis.

In a long distance telephone survey made by *The Cash Box* some weeks ago—we reported that mechanic's wages have gone up approximately 100 per cent in almost every territory; the wages of other, general help, had also risen about 75 per cent; supplies and parts have been hiked up about 50 per cent; coinmen who rent space for their offices, storage and shops, claim that this item alone is today 50% up and above pre-war

times; trucks, tires and maintenance have risen over 65%; and all the trade now knows that the new machines are at least 50% above pre-war prices. (These figures, as many coinmen have already written to *The Cash Box*, are conservative.)

Therefore, in view of these tremendous overhead increases, and in view of the fact that the machines themselves are so much higher in price necessitating many more months of location work to amortize their cost, the juke box operator must go on a 70%-30% commission basis if he wants to remain in a sound, liquid financial condition and also wants to be assured of a profitable future in his business.

There is only one problem which faces most of the coinmen when discussion arises about the 70%-30% commission basis. That is usually that "I, myself, agree with you and would immediately start on this basis—but, what about my competitors? They would use this to cripple my business."

The answer then is that coinmen must form themselves into cooperative groups (as has just been done in the state of Alabama) to assure themselves that when production really gets under way once again that they won't wind up being "machine poor"—but will have cash on hand (as they have today) to continue to buy new merchandise and increase their operations.

OPS ASK WILL TOO MANY SIMILAR MACHINES MEAN DIRECT SALES?

Cannot See How Trade Can Absorb All These When High Speed Production Gets Under Way Again

NEW YORK — At the present time a fear seems to have again arisen in the ranks of the operators thruout the country and there arises the question, "How is the trade going to be able to absorb so many similar machines?"

And the answer these men seem to be getting is, "It means that there will have to be direct sales to the locations when high speed production again gets under way."

In short, ops are of the fear that because so many similar type machines have appeared in the trade that some manufacturers will simply have to turn to direct sales to assure themselves sufficient business to cover the cost of production, experimentation, development, etc., etc.

What these coinmen seem to have forgotten are the early days of the pin games when there suddenly arose over 90 manufacturers who decided to make this sort of equipment.

Not only was the average operator confused, but he felt and believed that he didn't have to depend upon any one manufacturer anymore — "for the other guy is now making the same thing".

But, this didn't prove true. This is an entertainment industry. It is an industry wherein acceptance is subject to the public's whim and fancy. And the public, not the operator, jobber, distributor or manufacturer decided what games it wanted to play.

The result was that one manufacturer after another folded up his business—and the ones left are the

same who are manufacturing the "hit games" today.

There is now no doubt anymore that this same process of elimination will come into the industry. The public will once again decide which machines they like best.

But, here the trouble is that all these machines offer the same type of service—so it will be the choice that the storekeepers will also make which will decide to a great extent which machines will remain most popular.

The trade must also realize that such competition is a very healthy sign. It means that the competing manufacturers must present finer instruments to win the buyers to their side. Therefore, from every angle, the trade is today in a better position than it has ever been before.

It is very doubtful whether any manufacturer will turn to direct sales if this field turns his instrument down cold. He will then realize that if the men who specialize in the business into which he has entered, don't want his product—then surely the location owner and the public will not readily accept it.

The public is always guided by the choice of the experts. In this case the operators are the experts. They can and cannot buy and by not buying signify that they do not want the machine for it does not come up to the standards already set for the field by others.

Direct selling is a shortsighted practise. If it were any good—there

were manufacturers who would have entered into it years and years ago. These men learned that direct sales simply could not get the business needed to make them a powerful and outstanding concern. They either, then, returned to the trade or went out of business.

There are certain types of machines which do attract direct sales. For example, the bottle vending soft drink machines. The reason is simply that the operator could not earn enough to pay the overhead at the prices he would be forced to pay for the merchandise. Similarly, the bottler of soft drinks is in a much better position to handle such equipment.

There has already been statements made by large retailers that they will handle frozen food vendors, when they come into being, directly. In the first place, the frozen food market has not been sufficiently developed as yet to make it attractive to the coin machine trade. Secondly, these large stores will find frozen food vendors money savers to them from the standpoint of efficiency alone. Therefore, since the machines are right in their stores they will be able to better handle and control them. This is no more than what the Automat restaurants have proved.

But, in the case of other machines—it will simply be a process of elimination—with the best machines and the best manufacturers coming out on top.

JUKE BOX OPS DON'T PLAY PERSONAL RECORDINGS

Jersey Case Gives Trade Warning on Copyright Infringement. Stick to Standard Type Records. Don't Play Records Made by Customers at Their Request.

NEW YORK — The case reported in this past week's issue of *The Cash Box* regarding the fact that a telephone music operator had been advised by an attorney of a forthcoming suit because his studio had played a customer's record at this customer's request has instantly brought to the fore one of the grave problems which the juke box industry is faced with on infringement of copyrights.

This is what ASCAP, BMI, MPPA and the Buckley Bill drove at this industry with. There is no longer any doubt that the music machine business must watch each step it makes with great care. Juke box ops are warned not to overlook any suit, however small it may appear on the surface, but to instantly make contact with others who are carefully watching every maneuver of these organizations who are intent on making this industry pay them for the use of their music.

This trade must remember that if ASCAP can force the juke box operator to pay a license fee for the use of what they call their copyrighted music that they can collect in the neighborhood of some \$30,000,000 to \$50,000,000 per year from this business. It means that any such organization will continue to fight and to use every tactic and strategy it can to win precedents to establish its right to such collection. ASCAP has lost three cases already—but they're still trying—and won't give up. That was why the Buckley bill is so dangerous as long as it remains in Congress.

The fact that this New Jersey wired telephone music operator agreed to play one of the records made by a customer of his and play it into a requested location opened the way to this warning when this operator was advised that he was now going

to be sued for playing a tune that his customer did not write and he was therefore infringing on a copyrighted song.

Tho this has been a common practice among telephone music operators especially — the intelligent op will now stop playing any and all customer's personally made recordings—and only play the standard type records he purchases.

The answer to the entire record problem is what *The Cash Box* has been urging the industry to obtain. On every record label these words should appear, "FOR USE IN COIN OPERATED MUSICAL INSTRUMENTS."

But even this will not stop suits on copyright when music ops arrange to play recordings of their individual customers especially of songs not theirs.

OPEN CLOSED TERRITORY OPS CRY

NEW YORK — *The Cash Box* has been receiving letters from leading coinmen that the trade should now make every effort to open closed territories.

It is the belief of these men that once production gets under way in the volume expected from the manufacturers that most coinmen will be either too busy or will not give this need their complete attention.

"In short", one of these coinmen writes, "this the time, while we still can think clearly, coolly and calmly, and while we aren't jammed with new equipment, to begin to open closed territories. That will not only make the market bigger for everyone concerned, but it will mean that the industry will have the opportunity to expand and to grow the way that it should."

Another coinman advises that a group of operators in a mid-west city have come together and have held first discussions as to what can be done to open their area. They have contacted officials quietly and have spoken with attorneys of high caliber and outstanding reputation. These men are out to open their community in the one and only fashion — openly and without any hidden details.

In New York City there is also a movement afoot by a few coinmen who have made a complete research of existing regulations and have learned that the possibilities are there, if all other things are equal.

A western community has also found a few men working quietly for sometime now to learn just

what would be required to once again get their territory started on novelty pin tables and arcade machines.

It seems that in almost every case the plan is to open the cities with novelty games and most of the coinmen seem to be satisfied that these can earn them sufficient profit to make it worthwhile.

Since this is the plea and the plan of these ops, then surely the rest of the industry should cooperate for there is only one way out of the morass of closed territory in the nation. Not one of these coinmen is asking for the installation of the type of equipment which would cause much trouble for them. They all intend to work under laws and regulations now in existence.

OPEN

CLOSED

TERRITORY

OPEN

Faint, illegible text covering the lower half of the page, possibly bleed-through from the reverse side.

DISTRIBS YELL FOR EQUIPMENT

Claim this is Driest Point in History. Report Showrooms Empty and Only Trickle of New Machines Arriving.

NEW YORK — Reports arriving at the offices of *The Cash Box* from the nation's distributors are to the effect that this is the "driest point" ever yet reached in the industry as far as equipment is concerned.

The leaders in the wholesaling division report that most showrooms are bare. They also claim that new machines are arriving in a very tiny trickle thruout the country.

"This", one noted distributor stated, "is a point where we, in the distributing business, never before believed would ever be reached."

One distributor stated over the long distance telephone that, "The entire industry right at this minute can be likened to the Sahara Desert."

Some months ago (and also during the war) *The Cash Box* reported that the backlog demand for new equipment had reached the greatest record proportions in all history. Distributors and jobbers were willing to commit

themselves for amounts of equipment never before contracted for by the wholesale division of the business.

With existing conditions distributors are beginning to travel the nation to get whatever they can to keep the operators in their territories going

Some distributors had this to say, "We do fear the fact that all the manufacturers will suddenly bust loose at one time and flood the market with new machines." This, these men said, "stands to reason, for materials will loosen up at one time for all the factories. That means we can expect an avalanche of used machines upon us before we are even ready to accept them."

Others had this to say, "The used machine market will continue tight. The reason is that no operator will let go of good used machines for a long time to come to make sure that he has his locations covered. At the same time it must also be remembered that many used machines are off the market entirely for one rea-

son or another. There is no fear that an avalanche will pounce down on the distributors. As the new machines come thru in quantity the ops will, in most cases, take these without even making any trade-ins."

In the meantime leading distributors and jobbers everywhere in the country are urging manufacturers to attempt by all means to speed delivery of machines. They believe that this is the one and only solution to the present situation.

They are also asking that as the new games arrive the trade work with them to get these out to their customers by whatever best quota arrangement can be made.

If ever there was a need for new equipment it is right at this point. And from all indications it seems that the market will continue to remain tight and dry for a few more months to come. The manufacturers are trying as hard as they possibly can to get machines to the trade.

DIS TRIBS

YELL FOR

EQUIPMENT

Claim this is Direct Point in
History. Report Shows
Empty and Only Trickle of New
Machines Arriving.

EXCLUSIVE TO "THE CASH BOX"

RECORD REVIEWS

By

DAVE QUIRK

RECORD REVIEW EDITOR

OF

"THE CASH BOX"

"Harlemesque"**"I Know My Love Is True"****Joe Liggins and His Honeydrippers**
(Exclusive 212)

● The Liggins crew does a neat job of "Harlemesque," a pleasing number in the swing tempo. It should pay off wherever jazz fans gather. The backing is "I Know My Love Is True," with a vocal by Liggins himself. It's a ballad, with the band hyping it up in between choruses. Both sides are danceable.

"Queen for a Day"**"Out of a Dream"****Gloria Wood**
(4-Star 1059)

● Gloria Wood, a better than average gal singer, tees off on two vocal numbers, "Queen for a Day" and "Out of a Dream." Both are in the ballad vein and designed to keep the tears flowing as fast as the beer. One appeals to the gals, "Queen," and the other, "Dream," to the manly males in love. Good for beer parlors only, we would say.

"Rip Van Winkle"**"Yerxa"****Boyd Raeburn Orchestra**
(Jewel 10,001)

● Boyd Raeburn and his band are rated one of the top dozen in the country and we must admit we've heard them do much better work than on this disk. "Rip Van Winkle" is a novelty number spiced a bit by the vocal of Ginnie Powell. "Yerxa" is all instrumental and just fair Raeburn. High School and college youngsters like the Raeburn crew so this disk should go well in boxes on or near schools and campuses.

"Send Me a Man Amen"**"Put Your Head on My Shoulder"****Pat Kay**
(Urban 108)

● More and more we're becoming convinced that Pat Kay is one of the nation's gal warblers and this latest disk of hers is doubly good. Two good numbers, "Send Me a Man" and "Put Your Head" are matched up and Miss Kay handles both in grand style. "Send Me" is on the blues side and the backing, "Put Your Head," is more of the ballad type. But both are good and should take in plenty of coin for this gal can really sing.

"McNamara's Band"**"Dear Old Donegal"****Bing Crosby — The Jesters**
(Decca 23495)

● No matter what Bing Crosby waxes it's almost a sure bet for the juke boxes all over the country, and this disk of two Irish favorites will be no exception. Bing tops all in selling records, which is another way of saying he's a favorite with the music box fans. He really gets a brogue across on these two numbers, and the Jesters' background on both sides is tops. A great ribber, Bing couldn't resist a poke at his old pal, Bob Hope, so on "Donegal" he sneaked in the name of Jerry Colonna right in the middle of a whole string of good old Irish family names. It's a nice touch for a laugh.

**SLEEPER
OF THE WEEK****"Blazers Boogie"****The Three Blazers**
(Philo 111)

● For an easy - on - the - ear boogie, the Three Blazers have come up with "Blazers Boogie," a swell instrumental that will click in any spot and is a sure-fire magnet for a flood of nickels. Charles Brown's piano in this number is real top-drawer and Eddie Williams on bass and Johnny Moore on the guitar give him great support. It's a bangup trio doing a tip-top instrumental. And one of its best features is that it doesn't blow your eardrums out.

The flipover is "Baby Don't You Cry," with a nice vocal by Brown. This side, too, is out of the ordinary, making the disk a good buy for all operators. They're sure to get double value out of it.

"There's a Good Blues Tonight"**"As If I Didn't Have Enough****On My Mind"****Martha Tilton**
(Capitol 244)

● "There's A Good Blues Tonight," a takeoff on the famous news broadcaster, will be right up at the top with the most played disks in no time, but we have a hunch that it will be one of those overnight wonders that will die out as fast as it arrived. For one thing, the tune is reminiscent of a few others of the past like "Yes Indeed" and "Amen." But to give Martha Tilton her due, she sings this number in grand style. The flipover is a good, romantic ballad, sure of a play.

"One-zy Two-zy"**"We'll Gather Lilacs"****Tommy Jones Orch. and
Louise Tobin**
(Sterling 7001)

● The West Coast has been touting Tommy Jones and his band and their vocalist, Louise Tobin, and they are better than average. On "One-zy" the band overshadows Miss Tobin's yodeling but on the flipover, "Lilacs," she takes over and does a neat piece of work. It's a fair disk, with both sides slated for a decent play almost anywhere.

"Gotta Be This or That"**"I Never Stood a Chance"****Smart Set Quartet and
Clifford Lange Orchestra**
(Urban 104)

● Here's an old number, "Gotta Be This or That," handled in big league style by both orchestra and vocalists. The arrangement is tricky and the Smart Set Quartet gets all the worth out of this snappy tune. The group has good harmony and the number, as they do it, is sure to be a favorite in most spots. The backing, "I Never Stood a Chance," is on the torchy side and will appeal to listeners going through the throes of Spring fever.

"Along the Navajo Trail"**"Haven't Got a Nickel"****Russ Pike and His Prairie Knights**
(Enterprise 133)

● For spots that cater to cowboy fans, here's the old standby of such music, "Along the Navajo Trail," done in about as neat a fashion as you would want to hear. Russ Pike's crew know how to do this type of tune and the vocal is good cowboy. The flipover is more of the novelty western variety, "Haven't Got a Nickel," and the Knights do it up brown. The disk is a good one for the cowboy locales.

"C.O.D."**"No Greater Love"****Johnny Moore's Three Blazers**
(Exclusive 214)

● Here's the same small combo that recorded the Sleeper of the Week on a Philo label, and on "C.O.D." and "No Greater Love" the trio is excellent. "C.O.D." is a snappy number and the other is a ballad. Charles Brown again handles the vocals and does a swell job. It's a good trio and sure to be popular anywhere even with the knitting circles around the country.

RECEIVED
JAN 20 1900

Dear Sir,
I have the honor to acknowledge the receipt of your letter of the 15th inst. in relation to the above mentioned matter.

I am sorry to hear that you are not satisfied with the results of the investigation. I will endeavor to do all in my power to rectify the same.

I am, Sir, very respectfully,
Your obedient servant,
J. H. [Name]

Very truly yours,
J. H. [Name]

I have the honor to acknowledge the receipt of your letter of the 15th inst. in relation to the above mentioned matter.

I am sorry to hear that you are not satisfied with the results of the investigation. I will endeavor to do all in my power to rectify the same.

I am, Sir, very respectfully,
Your obedient servant,
J. H. [Name]

Very truly yours,
J. H. [Name]

I have the honor to acknowledge the receipt of your letter of the 15th inst. in relation to the above mentioned matter.

I am sorry to hear that you are not satisfied with the results of the investigation. I will endeavor to do all in my power to rectify the same.

I am, Sir, very respectfully,
Your obedient servant,
J. H. [Name]

Very truly yours,
J. H. [Name]

RECEIVED
JAN 20 1900

Mar. 25 Mar. 18 Mar. 11

VI-2D-1747—FREDDY MARTIN ORCH. <i>In the Middle of May</i>			
DE-18735—BING CROSBY — YOUNG ORCH. <i>Beautiful Love</i>			
DE-18737—GUY LOMBARDO ORCH. <i>Seems Like Old Times</i>			
CA-227—CHAPPELL MUSIC CO. <i>Day By Day</i>			
MA-7162—D. O'NEIL — R. NEWMAN ORCH. <i>Let It Snow! Let It Snow!</i>			
CA-227—JO STAFFORD <i>Day by Day</i>			
DE-4D0D2—JEAN SABLON <i>It Might as Well Be Spring</i>			
6—I'm Always Chasing Rainbows	46.5	52.7	61.0
CO-36899—HARRY JAMES ORCH. <i>Baby, What You Do to Me</i>			
DE-23472—H. FORREST — D. HAYMES <i>Tomorrow is Forever</i>			
VI-20-1788—PERRY COMO — CASE ORCH. <i>You Won't Be Satisfied, etc.</i>			
VI-28-04D2—AL GOODMAN ORCH. <i>If I Loved You</i>			
DE-18789—GUY LOMBARDO ORCH. <i>Make Believe</i>			
7—Let It Snow! Let It Snow!	42.6	61.8	81.8
VI-20-1759—VAUGHN MONROE ORCH. <i>When the Sandman Rides the Trail</i>			
DE-18741—CONNIE BOSWELL—R. MORGAN <i>Walkin' With My Honey</i>			
CO-369D9—WOODY HERMAN ORCH. <i>Everybody Knew But Me</i>			
MA-7162—D. O'NEIL—R. NEWMAN ORCH. <i>Symphony</i>			
8—One-Zy, Two-Zy (I Love You-Zy)	39.1	36.4	3.1
MA-7174—THE DE MARCO SISTERS <i>I Fall in Love with You, etc.</i>			
VI-2D-1826—FREDDY MARTIN <i>Sleepy Baby</i>			
9—Shoo Fly Pie and Apple Pan Dowdy	34.5	39.4	35.9
CA-235—STAN KENTON O. <i>I Been Down in Texas</i>			
CO-36943—DINAH SHORE <i>Here I Go Again</i>			
10—Day By Day	29.0	53.9	37.9
CA-227—JO STAFFORD <i>Symphony</i>			
CO-36950—FRANK SINATRA <i>Oh! What It Seemed to Be</i>			
CO-36945—LES BROWN ORCH. <i>Doctor, Lawyer, Indian Chief</i>			
DE-18746—BING CROSBY—M. TORRE <i>Prove It By the Things You Do</i>			
VI-20-1828—MARTHA STEWART <i>Tomorrow Is Forever</i>			
11—I Can't Begin to Tell You	25.2	23.0	56.6
CA-221—A. RUSSELL—WESTON ORCH. <i>Love Me</i>			
CO-36867—HARRY JAMES ORCH. <i>Waitin' for the Train to Come In</i>			
DE-23457—BING CROSBY <i>I Can't Believe That You're in Love with Me</i>			
VI-2D-1720—SAMMY KAYE ORCH. <i>What Makes the Sunset?</i>			
12—Slowly	22.1	28.5	21.7
CO-36900—KAY KYSER ORCH. <i>I Don't Wanna Do It Alone</i>			
DE-18747—DICK HAYMES <i>I Wish I Could Tell You</i>			
13—Some Sunday Morning	20.1	36.3	15.7
CO-36839—KATE SMITH <i>Dearest Darling</i>			
DE-23434—HAYMES-FORREST <i>I'll Buy That Dream</i>			
20-1711—HAL MCINTYRE ORCH. <i>Autumn Serenade</i>			
MA-7163—LOUIS PRIMA <i>Everyone Knew But Me</i>			
14—Hey, Bo-Ba-Re-Bop	17.8	14.6	4.6
DE-18754—LIONEL HAMPTON O. <i>Slide, Mamp, Slide</i>			
15—All Through the Day	16.9	1.1	
CA-240—MARGARET WHITING <i>In Love in Vain</i>			
CO-36962—FRANK SINATRA <i>Two Hearts are Better, etc.</i>			
DE-23528—DICK HAYMES—H. FORREST <i>In Love in Vain</i>			
VI-20-1814—PERRY COMO—CASE ORCH. <i>Prisoner of Love</i>			
16—Atlanta G.A.	13.4	12.1	3.0
CO-36949—WOODY HERMAN O. <i>Wild Root</i>			
VI-20-1795—SAMMY KAYE O. <i>I Didn't Mean a Word I Said</i>			
17—Seems Like Old Times	13.2	1.5	11.7
DE-18737—GUY LOMBARDO ORCH. <i>Symphony</i>			

Mar. 25 Mar. 18 Mar. 11

MA-1D30—THELMA CARPENTER <i>A Jug of Wine</i>			
VI-20-1811—VAUGHN MONROE ORCH. <i>Geel I Wish</i>			
18—Don't You Remember Me	12.0	6.6	3.1
IO-36888—FRANKIE CARLE O. <i>Prove It By the Things You Do</i>			
VI-2D-1796—J. DESMOND—CASE O. <i>In the Eyes of My Irish Colleen</i>			
19—I'm Glad I Waited For You	11.6	9.1	2.1
CA-218—PEGGY LEE <i>Waitin' for the Train, etc.</i>			
CO-369D5—FRANKIE CARLE ORCH. <i>No Baby, Nobody But You</i>			
DE-18723—HELEN FORREST <i>My Guy's Come Back</i>			
MA-7164—PAXTON ORCH.—ALAN DALE <i>Oh! What It Seemed to Be</i>			
VI-2D-1749—FREDDY MARTIN ORCH. <i>Rachmaninoff Concerto No. 2</i>			
20—Prisoner of Love	10.9	1.8	
VI-20-1814—PERRY COMO—CASE ORCH. <i>All Through the Day</i>			
21—Artistry Jumps	8.1		3.2
DE-18720—BING CROSBY <i>In the Land of Beginning Again</i>			
MA-7158—GEORGE OLSEN <i>Good Time Palko</i>			
VI-2D-1728—TOMMY DORSEY <i>A Dear Will Open</i>			
CO-36875—LES BROWN ORCH. <i>The Last Time I Saw You</i>			
CA-225—P. PIPERS—WESTON ORCH. <i>In the Middle of May</i>			
23—I'm o Big Girl Now	7.7	14.5	3.4
VI-20-1812—SAMMY KAYE ORCH. <i>Put Your Little Foot Right Out</i>			
24—Dig You Later	7.4	16.4	18.2
VI-2D-1750—PERRY COMO <i>Here Comes Heaven Again</i>			
25—Where Did You Learn to Love	7.0	1.1	
MA-7172—LOUIS PRIMA ORCH. <i>Gimme o Little Kiss</i>			
VI-20-1819—TOMMY DORSEY ORCH. <i>Come Rain or Come Shine</i>			
26—McNamora's Band	6.6	15.1	8.1
VI-20-1827—JOHN RYAN <i>It's the Same Old Shillelagh</i>			
DE-23495—BING CROSBY—JESTERS <i>Dear Old Danegal</i>			
27—Sioux City Sue	6.2		
28—It Might as Well Be Spring	5.8	4.2	17.2
DE-18706—DICK HAYMES—YOUNG <i>That's for Me</i>			
VI-20-1725—VAUGHN MONROE ORCH. <i>Talkin' to Myself About You</i>			
CA-214—PAUL WESTON ORCH. <i>How Deep is the Ocean</i>			
VI-20-1738—SAMMY KAYE <i>Give Me the Simple Life</i>			
CO-36893—RAY NOBLE ORCH. <i>Full Moon and Empty Arms</i>			
DE-4D0D2—JEAN SABLON <i>Symphony</i>			
29—Warsow Concerto	5.6	4.8	3.6
DE-18742—CARMEN CAVALLARO <i>A Love Like This</i>			
DE-29150—LOS ANGELES PHILHARMONIC <i>DE-18484—ALEC TEMPLETON (2 PARTS)</i>			
DE-18417—VICTOR YOUNG ORCH. (2 PARTS) <i>VI-11-8863—BOSTON POPS ORCH. (PARTS)</i>			
VI-20-1535—FREDDY MARTIN ORCH.			
30—You Can Cry on Somebody Else's Shoulder	5.5	-1.0	5.6
31—Bells of St. Mary's	5.4	6.7	6.6
DE-18721—BING CROSBY—TROTTER ORCH. <i>I'll Take You Home Again</i>			
DE-183D2 (315) FRED WARING ORCH. AND GLEE CLUB <i>In a Monastery Garden</i>			
VI-20-1791—CHARLESPIVAK ORCH. <i>You Can Cry on Somebody Else's Shoulder</i>			
DE-183D2 (315) FRED WARING O. AND GLEE CLUB <i>In a Monastery Garden</i>			
VI-11-9155—VICTOR CHORALE <i>The Lord's Prayer</i>			
32—You're Nobody 'Till Somebody Loves You	5.2		7.6
33—I Didn't Mean a Word I Said	5.0	1.9	3.2
CA-238—JO STAFFORD—WESTON ORCH. <i>You May Not Love Me</i>			
MA-7171—DONNY O'NEIL <i>One More Tomorrow</i>			
VI-20-1795—SAMMY KAYE ORCH. <i>Atlanta, G. A.</i>			

Mar. 25 Mar. 18 Mar. 11

34—Come to Soby, Do	4.6	-1.0	6.7
CO-36884—LES BROWN ORCH. <i>You Won't Be Satisfied</i>			
DE-18716—JIMMY DORSEY <i>Autumn Serenade</i>			
MA-7153—JACK SMITH <i>One More Dream</i>			
CA-224—KING COLE TRIO <i>Tell Ya What I'm Gonna Do</i>			
VI-2D-1748—DUKE ELLINGTON ORCH. <i>Frim Fram Sauce</i>			
35—In the Moon Mist	3.8	-1.0	
CA-243—PIED PIPERS—WESTON ORCH. <i>Madama Butterball</i>			
DE-18752—RANDY BROOKS <i>Don't Let Me Dream</i>			
MA-7170—JACK LEONARD <i>You May Not Love Me</i>			
VI-20-1810—J. DESMOND—CASE ORCH. <i>Do You Love Me?</i>			
36—Waitin' for the Train To Come In	3.7	-1.0	2.0
DE-18718—JOHNNY ROBERTSON <i>Fishin' for the Moon</i>			
MA-7156—LOUIS PRIMA <i>Just a Little Fond Affection</i>			
CA-218—PEGGY LEE WITH ORCH. <i>I'm Glad I Waited for You</i>			
CO-36867—HARRY JAMES ORCH. <i>I Can't Begin to Tell You</i>			
37—Money Is the Root of All Evil	3.5	6.0	11.1
DE-23474—ANDREWS—LOMBARDO ORCH. <i>Johnny Fedora</i>			
38—Buzz Me	3.1	2.4	1.0
CA-226—ELLA MAE MORSE <i>Rip Van Winkle</i>			
DE-18734—LOUIS JORDAN <i>Don't Worry 'Bout That Mule</i>			
VI-20-1808—HENRY "RED" ALLEN <i>Get the Map</i>			
39—One More Dream	2.7	1.0	1.4
CA-228—JOHNNY JOHNSTON <i>As Long as I Live</i>			
CO-369D3—THE CHARIOTEERS <i>No Soap</i>			
MA-7153—JACK SMITH <i>Come to Baby, Do</i>			
40—Nancy	2.6	2.6	3.0
CO-36868—FRANK SINATRA <i>Crdle Song</i>			
41—Toke Core When You Say "Te Quiero"	2.5	1.3	2.5
CO-36916—TOMMY TUCKER <i>When the One You Love</i>			
DE-18730—GUY LOMBARDO ORCH. <i>Dearest Darling</i>			
VI-20-1806—CHARLIE SPIVAK ORCH. <i>Oh! What It Seemed to Be</i>			
42—Give Me o Little Kiss, Will You Huh?	2.3	2.5	2.0
DE-23481—D. HAYMES—H. FORREST			
43—Patience and Fortitude	2.1	1.2	7.7
CO-36946—COUNT BASIE ORCH. <i>The Mad Boogie</i>			
DE-18780—ANDREWS SISTERS <i>Red River Valley</i>			
MA-7169—RAY MCKINLEY ORCH. <i>You've Got Me Crying Again</i>			
44—Madome Butterball	2.0		
45—If I Had a Wishing Ring	1.9	1.4	14.1
CA-234—A. RUSSELL—P. WESTON ORCH. <i>Without You</i>			
VI-20-1809—TOMMY DORSEY ORCH. <i>We'll Gather Lilacs</i>			
46—Chickery Chick	1.8	-1.0	3.5
VI-20-1726—SAMMY KAYE ORCH. <i>I Last My Job Again</i>			
CO-36877—GENE KRUPA AND ORCH. <i>Just o Little Fond Affection</i>			
DE-18725—EVELYN KNIGHT—JESTERS <i>Let Him Go — Let Him Tarry</i>			
MA-7155—GEORGE OLSEN <i>Kentucky Babe</i>			
47—Everybody Knew But Me	1.7	19.4	10.1
DE-18778—HELEN FORREST <i>Baby, What You Do to Me</i>			
MA-7163—LOUIS PRIMA <i>Some Sunday Morning</i>			
CO-36909—WOODY HERMAN <i>Let It Snow! Let It Snow!</i>			
VI-20-1798—DINAH SHORE <i>I Can't Believe That You're in Love with Me</i>			
48—Coax Me o Little Bit	1.6		
49—Just a-Sittin' and a-Rockin'	-1.0	1.2	6.1
CA-229—STAN KENTON ORCH. <i>Artistry Jumps</i>			
DE-18739—DELTA RHYTHM BOYS <i>Don't Knock It</i>			
MA-1023—T. CARPENTER—FREEMAN ORCH. <i>Hurry Home</i>			
50—Don't Be o Baby, Baby	-1.0	1.7	1.0
DE-18753—MILLS BROTHERS <i>Never Make a Promise, etc.</i>			

Mar. 25 Mar. 18 Mar. 11

THE CASH BOX

DISC-HITS
BOX SCORECOMPILED BY
JACK "One Spot" TUNNISIN ORDER OF POPULARITY
BASED ON
WEEKLY NATIONAL SURVEYBOX SCORE TABULATION COMPILED ON THE AVERAGE
INDIVIDUAL PURCHASE ON THE BASIS OF 1000 REC-
ORDS—LISTED IN ORDER OF POPULARITY, INCLUDING
NAME OF SONG, RECORD NUMBER, ARTISTS, AND REC-
ORDING ON THE REVERSE SIDE.

CODE

BB—BLUEBIRD DE—DECCA
CA—CAPITAL MA—MAJESTIC
CO—COLUMBIA VI—VICTOR

RECORDING COMPANIES LISTED ALPHABETICALLY

Mar. 25 Mar. 18 Mar. 11

1—Oh! What It Seemed To Be	143.8	140.0	126.3
CO-36892—FRANKIE CARLE ORCH. <i>As Long as I Live</i>			
CO-36905—FRANK SINATRA <i>Day by Day</i>			
MA-7164—PAXTON ORCH.—ALAN DALE <i>I'm Glad I Waited for You</i>			
VI-20-1806—CHARLIE SPIVAK <i>Take Care When You Say</i>			
DE-23481—D. HAYMES—H. FORREST <i>Give Me a Little Kiss, etc.</i>			
2—Doctor, Lawyer, Indian Chief	124.4	103.0	109.6
CA-220—B. HUTTON — WESTON ORCH. <i>A Square in the Social Circle</i>			
CO-36945—LES BROWN ORCH. <i>Day by Day</i>			
3—Personality	105.8	101.2	89.8
CA-230—JOHNNY MERCER <i>If I Knew Then</i>			
VI-20-1781—D. SHORE — CASE ORCH. <i>Welcome to My Dream</i>			
CO-36930—PEARL BAILEY <i>Don't Like 'Em</i>			
VI-20-1807—H. CARROLL—R. CASE ORCH. <i>Mama Never Told Me</i>			
DE-18790—BING CROSBY <i>Would You</i>			
4—You Won't Be Satisfied (Until You Break My Heart)	79.1	73.3	61.1
CO-36884—LES BROWN ORCH. <i>Come to Baby, Do</i>			
MA-1029—LOUIS PRIMA ORCH. <i>Brooklyn Boogie</i>			
MA-7144—LOUIS PRIMA ORCH. <i>There's a Broken Heart, etc.</i>			
VI-20-1788—PERRY COMO—CASE ORCH. <i>I'm Always Chasing Rainbows</i>			
DE-23496—FITZGERALD—ARMSTRONG <i>The Frim Fram Sauce</i>			
5—Symphony	70.1	75.2	97.5
CO-36874—BENNY GOODMAN ORCH. <i>My Guy's Come Back</i>			
DE-23456—MARLENE DIETRICH <i>Lili Marlene</i>			

C.M.I. BLUE BOOK

FOREWORD Many times, wide differences appear in the high and low prices of certain equipment. Like any true reporter The C.M.I. Blue Book can only feature the market prices as they are quoted. The C.M.I. Blue Book acts exactly the same as the market quotation board at the Stock Exchange—posting the prices as they are quoted for the past week, regardless of how much they may seem to be out of line. Some prices do not change for months. The C.M.I. Blue Book, rather than show no price, retains the last known quotations for such equipment so that the subscriber at least has the last known prices as a basis to work with. Prices continue to be very widely divergent these days. Someone on the West Coast may feel a certain machine worth \$150.00 whereas someone on the East Coast may think it worth but \$75.00. Of course, condition, serial, appearance, demand, territory, quantity, etc., must all be taken into consideration. The C.M.I. Blue Book reports each quotation exactly as it is made and depends on the subscriber to make average price adjustment to fit the peculiarities of his own territory.

METHOD The C.M.I. Blue Book should be read as follows: First price listed is lowest price for the week: Second price listed is highest price. Where only one price appears this should be considered lowest price.

IMPORTANT Machines underlined mean these were most active in trading the past week.

CODE Check this code carefully. Become acquainted with each one of the code numbers and what they signify. These code numbers appear in front of the name of each machine.

1

MEANS PRICE
WENT UP.

2

MEANS PRICE
WENT DOWN.

3

MEANS MACHINE JUST ADDED
TO LIST.

4

MEANS PRICES WENT UP AND DOWN
DURING THE PAST WEEK.

5

MEANS PRICES REMAINED SAME AS
IN LAST PRICE LISTS.

6

MEANS NO PRICES QUOTED FOR PAST
TWO WEEKS.

7

MEANS NO PRICES QUOTED FOR PAST
THREE WEEKS.

XX

MEANS NO PRICES QUOTED FOR
MANY WEEKS — PRICE SHOWN IS
LAST KNOWN QUOTATION.

THE CASH BOX

"THE CONFIDENTIAL WEEKLY OF
THE COIN MACHINE INDUSTRY"

ISSUED EVERY WEEK. REPRODUCTION IN WHOLE
OR IN PART FORBIDDEN WITHOUT WRITTEN PER-
MISSION FROM THE PUBLISHERS. COMPLETE
CONTENTS COPYRIGHTED.

PUBLICATION OFFICES

381 FOURTH AVENUE, NEW YORK 16, NEW YORK
ALL PHONES: MURRAY HILL 4-7797

CHICAGO OFFICE

32 W. RANDOLPH ST., CHICAGO 1, ILLINOIS
HELEN PALMER, Mgr. ALL PHONES: DEARBORN 0045

LOS ANGELES OFFICE

422 W. 11th ST., LOS ANGELES 15, CALIFORNIA
MARSHALL MICON, Mgr. ALL PHONES: PROSPECT 2687

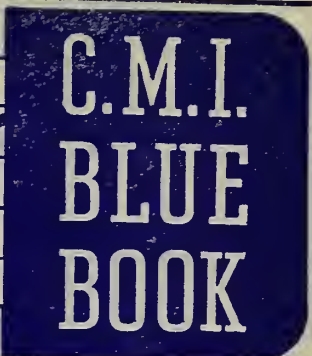
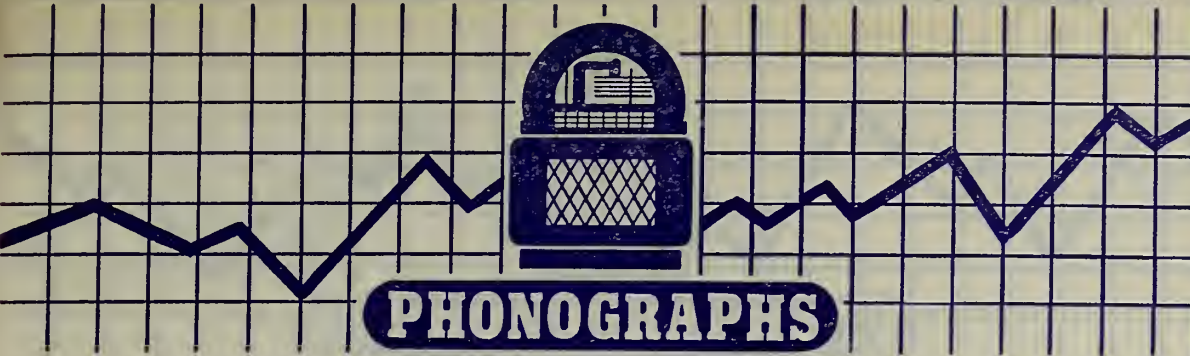

WURLITZER

xx. P-10	\$49.50	\$75.00
xx. P-10, Ill.	65.00	69.50
1. P-12	75.00	150.00
xx. P-12, Ill.	109.50	139.00
6. 312	85.00	150.00
xx. P-400	59.50	99.50
5. 412	125.00	179.00
xx. 412 DC Cr.	32.50	
xx. 412, Ill.	100.00	159.50
xx. 316	100.00	125.00
xx. 416	105.00	135.00
1. 616	200.00	285.00
5. 616, Ill.	249.50	275.00
xx. 616 A	145.00	225.00
xx. 716	175.00	225.00
5. 24	285.00	335.00
xx. Revamp (24)	275.00	295.00
1. 600R	400.00	475.00
5. 600K	425.00	475.00
2. 500	435.00	495.00
xx. 500K	425.00	475.00
xx. 500A	395.00	425.00
1. 41 (Counter)	125.00	189.50
5. 51 (Counter)	110.00	150.00
2. 61 (Counter)	139.50	149.50
2. 71 (Counter)	125.00	209.00
xx. 81 (Counter)	150.00	225.00
xx. 50	75.00	129.50
6. 700	610.00	675.00
2. 750M	500.00	650.00
2. 750E	525.00	750.00
xx. 780M Colonial	550.00	675.00
5. 780E	610.00	795.00
5. 800	675.00	750.00
1. 850	745.00	825.00
2. 950	725.00	775.00
2. 42-24 (Rev)	395.00	495.00
<hr/>		
1. 42-500 (Rev)	499.50	595.00
5. 42-600 (Rev)	450.00	495.00
1. 300 Adaptor	19.50	32.95
2. 320 Wireless Wall Box	17.00	20.00
xx. 310 Wall Box, 30 Wire	2.00	12.00
6. 320-2 Wire Wall Box	20.00	22.95
xx. 332-2 Wire Bar Box	9.50	10.00
5. 331-2 Wire Bar Box	9.50	14.00
5. 304-2 Wire Stepper	17.50	19.50
xx. Wireless Strollers	25.00	
6. 430 Speaker Cab. with 5-10-25 Box	79.95	150.00
xx. 420 Speaker Cabinet	50.00	
xx. Twin 616 Steel Cabinet		
Adp. Amp. Stp. Speaker	150.00	295.00
5. Twin 12 Steel Cabinet		
Adp. Amp. Stp.	175.00	210.00
xx. Selector Speaker	95.00	100.00
2. 100 Wall Box 5c 30 Wire	10.50	12.00
xx. 100 Wall Box 10c	17.50	
5. 111 Bar Box	8.50	15.00
2. 125 Wall Box, 5, 10, 25	20.00	37.50
1. 120 Wall Box	20.00	29.50
6. Bar Brackets	2.00	3.50
1. 305 Impulse Rec.	2.50	25.00
xx. 350 Wls. Speaker	20.00	
xx. 115 Wall Box Wire	15.00	
5. 135 Step Receiver	17.50	35.00
2. 145 Imp. Step. Fast	25.00	45.00
xx. 150 Impulse Rec.	20.00	
xx. 337 Bar Box	32.50	
5. 306 Music Transmit	10.00	19.50
xx. 39A Speaker	25.00	
6. 130 Adaptor	24.50	37.95
xx. 24 Steel Cab. Speaker	140.00	175.00
5. 580 Speaker	149.00	

ROCKOLA

1. 12 Record	\$125.00	\$150.00
7. 16 Record	125.00	175.00
6. Rhythm King 12	69.50	125.00
6. Rhythm King 16	135.00	175.00
xx. Imperial 16	125.00	169.50
5. Imperial 20	250.00	295.00
xx. Windsor	237.50	310.00
6. Monarch	215.00	250.00
xx. Windsor, Ill.	250.00	300.00
6. Std. Dial-A-Tone	325.00	475.00
5. '40 Super Rockolite	450.00	495.00
xx. Counter '39	125.00	165.00
5. '39 Standard	300.00	400.00
5. '38 DeLuxe	350.00	450.00
xx. '40 Super Walnut	340.00	365.00
6. '40 Super Marble	450.00	475.00
xx. '40 Master Walnut	335.00	365.00
1. '40 Master Rockolite	440.00	475.00
xx. '40 Counter	165.00	195.00
xx. '40 Counter with Std.	139.50	
1. '41 Premier	525.00	595.00
1. Wall Box	10.00	12.50
7. Bar Box	10.00	17.50
xx. Spectravox '41	65.00	115.00
xx. Glamour Tone Column	95.00	
xx. Modern Tone Column	50.00	69.50
xx. Playmaster & Spectravox	350.00	425.00
xx. Twin 12 Cab. Speak	175.00	
xx. 20 Rec. Steel Cab ASA	109.50	
xx. Playboy	30.00	
5. Commando	545.00	650.00
xx. 1501 Wall Box	5.00	10.00
xx. 1502 Bar Box	3.50	6.00
xx. 1503 Wall Box	19.50	20.00
5. 1504 Bar Box	24.50	27.50
xx. 1510 Bar Box	25.00	
xx. 1525 Wall Box	27.50	45.00
7. 1526 Bar Box	30.00	42.50
5. Dial-A-Tone B&W Box	15.00	17.50
xx. 1805 Organ Speaker	37.50	50.00
xx. Tone-A-Lier	54.50	
xx. DeLuxe Jr. Console Rock	150.00	
xx. Playmaster	295.00	375.00

A. M. I.

4. Hi-Boy 302	425.00	549.50
5. Singing Towers 201	450.00	475.00
xx. Streamliner 5-10-25	275.00	595.00
5. Top Flight	275.00	
xx. Model V-5 Phono	60.00	
xx. Singing Towers Speak	15.00	
xx. Singing Towers (301)	275.00	325.00

BUCKLEY

4. New Wall Box	15.00	20.00
2. New Bar Box	15.00	20.00
xx. Wall & Bar Box Old Style	3.50	4.50
5. Ill. Wall & Bar Box	24.50	27.50
5. 32 Record Adaptor	14.95	17.50
xx. 24 Record Adaptor	15.00	
xx. 16 Record Adaptor	15.00	
xx. Steel Cabinet	10.00	20.00
xx. Zephyr Speak Cab.	11.25	
xx. 20 Rec. Seeburg Adaptor	25.00	39.50
5. Bar Brackets	.95	2.50

C.M.I. BLUE BOOK

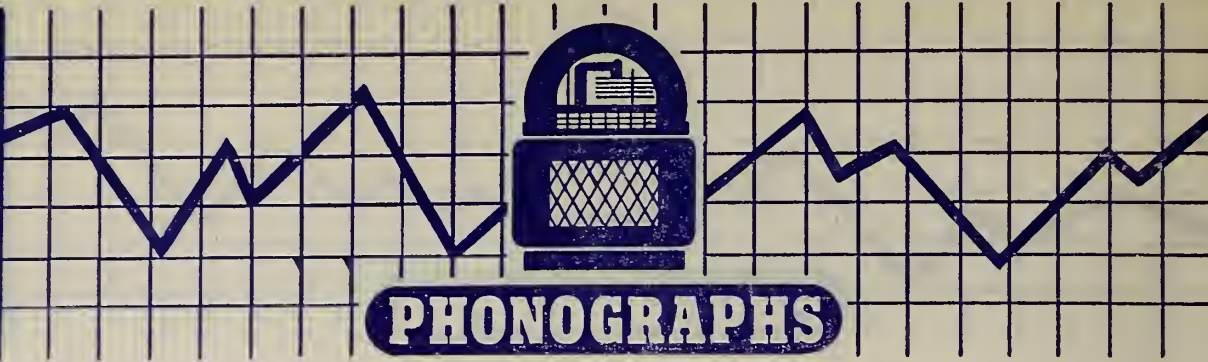

SEEBURG

xx .Selectomatic 10	\$35.00	\$75.00
2. Symphonola	110.00	149.50
xx. Model A III	85.00	115.00
xx. Model B	62.50	100.00
xx. Model C	37.50	
xx. Model H	100.00	
1. Rex	175.00	205.00
xx. Rex, with adaptor	239.50	
xx. Model K-15	95.00	149.50
5. Model K-20	160.00	325.00
xx. Royale	150.00	225.00
6. Plaza	289.50	375.00
4. Regal	300.00	435.00
xx. Regal, RC	300.00	385.00
xx. Model A	125.00	
2. Gem	200.00	300.00
xx. Classic	400.00	450.00
xx. Classic, RC	425.00	525.00
xx. Mayfair	295.00	370.00
xx. Melody King	125.00	135.00
6. Crown	299.50	399.50
xx. Crown, RC	345.00	
xx. Concert Grand	285.00	325.00
1. Colonel	445.00	525.00
xx. Colonel, RC	450.00	550.00
xx. Concert Master, RC	575.00	
xx. Cadet	350.00	425.00
xx. Cadet, RC	425.00	475.00
1. Major	375.00	425.00
xx. Major, RC	385.00	395.00
2. Envoy	395.00	425.00
1. Envoy, RC	450.00	525.00
1. Vogue	350.00	450.00
xx. Vogue, RC	450.00	500.00
1. Casino	265.00	300.00
xx. Casino, RC	239.50	389.50
xx. Commander	335.00	485.00
1. Commander, RC	395.00	525.00
5. Hi-Tone 9800	550.00	625.00
2. Hi-Tone 9800 RC	625.00	675.00
1. Hi-Tone 8800	595.00	625.00
1. Hi-Tone 8800 RC	595.00	675.00
5. Hi-Tone 8200	425.00	625.00
1. Hi-Tone 8200 RC	675.00	745.00
xx. 20 Record '43 Cabt	459.50	475.00
xx. Playboy	10.00	18.00
xx. Selectomatic 16	4.50	6.50
xx. Selectomatic 20	5.00	7.50
xx. Selectomatic 24	8.00	8.50
5. Remote Speak Organ	22.50	35.00
xx. Multi-Selector 12 Rec	69.50	
xx. Melody Parade Bar	4.50	
2. 5c Wall-O-Matic Wireless	28.50	39.50
xx. 5c Bar-O-Matic Wireless	29.00	37.00
2. 5c Wall-O-Matic 3 Wire	20.00	35.00
5. 30 Wire Wall Box	5.00	10.00
xx. Power Supply	15.00	
xx. 5, 10, 25c Bar-O-Matic 3-Wire	32.50	47.50
xx. 5, 10, 25c Wall-O-Matic 3-Wire	32.50	47.50
xx. 5c, 10, 25c Wall-O-Matic Wireless	45.00	52.50
5. 5, 10, 25c Bar-O-Matic Wireless	42.50	49.50
2. Electric Speaker	29.50	30.00
xx. Wireless Stroller	17.50	27.50
5. Wall Brackets	2.50	
5. Wired Speak Organ	24.50	25.00

KEENEY

5. Wall Boxes	\$2.00	\$5.00
xx. Adaptor for Seeburg	25.00	
xx. Adaptor for Rockola	27.50	
xx. Adaptor for 616 Wurlitzer	15.00	
xx. Twin 12 Adaptor	25.00	37.50
xx. Wurlitzer 24 Adaptor	15.00	
2. Adaptor for Mills Empress	20.00	25.00
xx. Organ Speaker	35.00	
xx. Sun Ray Speaker	25.00	
xx. Bar Brackets	2.50	3.50

MILLS

7. Zephyr	89.00	160.00
xx. Studio	70.00	100.00
7. Dance Master	70.00	135.00
xx. DeLuxe Dance Master	50.00	52.50
xx. Do-Re-Mi	50.00	125.00
1. Panoram	295.00	425.00
1. Throne of Music	295.00	375.00
xx. Throne with Adaptor	275.00	285.00
7. Empress	350.00	395.00
xx. Panoram Adaptor	8.50	
xx. Panoram 10 Wall Box	8.50	
xx. Speaker	10.00	
xx. Panoram Peek (Con)	275.00	375.00
xx. Conv. for Panoram Peek	12.50	

GABEL

xx. 12 Record, Jr.	42.50	75.00
xx. 12 Record with Adaptor	58.50	
xx. 12-12 Adaptor	94.00	
xx. 18 Rec. Ill. Grill	20.00	52.50
xx. 18 with Adaptor	99.50	125.00
xx. 20 Record Lite Up	225.00	265.00
xx. 24 Record Last Mdl	75.00	95.00

PACKARD

2. Play Mor Wall and Box	22.50	36.95
5. Bar Bracket	2.50	5.00
xx. Willow Adaptor	18.00	
xx. Chestnut Adaptor	25.00	36.50
xx. Cedar Adaptor	30.00	39.50
xx. Poplar Adaptor	25.00	46.50
xx. Maple Adaptor	30.50	
xx. Juniper Adaptor	29.00	31.00
xx. Elm Adaptor	25.00	
xx. Pine Adaptor	25.00	
xx. Beech Adaptor	20.00	43.50
xx. Spruce Adaptor	35.00	45.00
xx. Ash Adaptor	25.00	35.00
xx. Walnut Adaptor	25.00	36.50
xx. Lilly Speaker	17.00	20.00
xx. Violet Speaker	21.00	24.50
xx. Orchid Speaker	50.00	63.00
xx. Iris Speaker	55.00	59.50

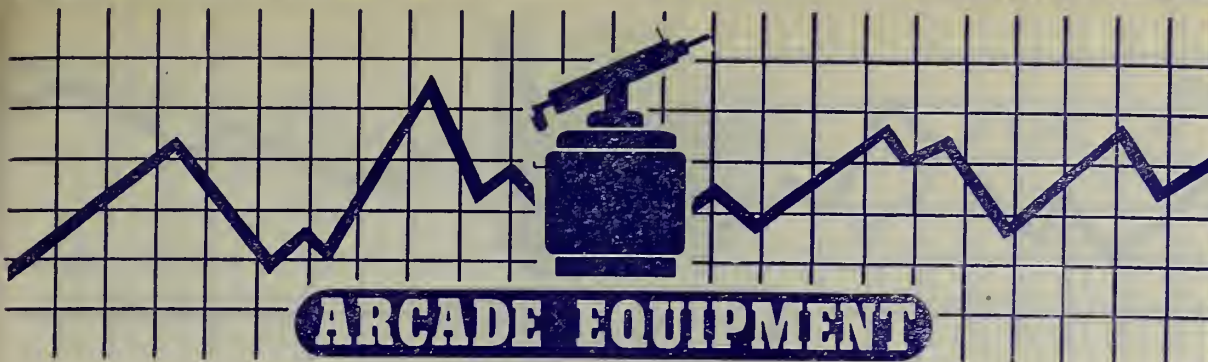

ARCADE EQUIPMENT

**C.M.I.
BLUE
BOOK**

6. Atlas Baseball	\$75.00	\$85.00	5. Midget Skee Ball	\$75.00	\$95.00
1. A.B.T. 6 Gun Rifle Rg.	1500.00	1900.00	xx. Midget Skee Ball DeL.	75.00	90.00
6. Bally Alley	29.50	55.00	xx. Mills Rotary Digger	29.50	49.50
2. Bally Basketball	75.00	89.50	1. Mutoscope Ace Bomber	225.00	275.00
2. Bally Convoy	95.00	175.00	xx. Mutoscope Bowl. Alley	110.00	
4. Bally Defender	199.50	249.50	2. Mutoscope Dr. Mobile	250.00	279.50
xx. Bally Eagle Eye	49.50		xx. Mutoscope Dr. Mobile w. tk	260.00	325.00
2. Bally King Pin	170.00	195.00	2. Mutoscope Elec. Trav. Crane	49.50	50.00
5. Bally Lucky Strike	79.50	125.00	xx. Mutoscope Fan Ft. Dig	40.00	54.50
2. Bally Rapid Fire	49.50	175.00	1. Mutoscope Photomatic	500.00	1000.00
2. Bally Bull Jap Con	25.00	49.50	6. Mutoscope Roll Frt. Cr.	50.00	69.50
6. Bally Shoot-the-Bull	49.50	95.00	1. Mutoscope Sky Fighter	174.50	275.00
2. Bally Sky Battle	140.00	164.50	xx. Mutoscope Sky Fighter		
6. Bally Racer	50.00	80.00	w. con.	200.00	229.50
2. Bally Torpedo	137.50	149.50	xx. Mutoscope Hockey	37.50	65.00
5. Bally Undersea Raider	299.50	399.50	xx. Mutoscope Magic Fing	85.00	125.00
xx. Bang-A-Deer	35.00	57.50	6. Mutoscope Pokerino	75.00	119.50
5. Bank Ball	375.00		5. Munves Super Skee Roll	349.50	
xx. Bell-O-Ball	35.00	150.00	xx. Munves Trap-the-Jap	150.00	
xx. Blister Gunner Con	10.00		xx. Pennant	35.00	49.50
1. Bowl-A-Bomb	150.00	175.00	2. Periscope	149.50	169.50
1. Bowling League	150.00	175.00	5. Pilot Trainer	850.00	
2. Buckley DeLuxe Dig	85.00	99.50	2. Pitchem & Catchem	75.00	125.00
2. Buckley Treas. Is. Dig	55.00	59.50	2. Poker & Joker	55.00	69.50
xx. Casino Golf	15.00	45.00	1. Radio Rifle	20.00	95.00
5. Chicoin Goalee	525.00		xx. Rockola Ten Pins LD	35.00	39.00
2. Chicoin Hockey	164.50	210.00	6. Rockola Ten Pins HD	40.00	69.50
6. Chicoin Rola Score	95.00	125.00	7. Rockola Tom Mix Rifle	25.00	39.50
2. Chester Pollard Golf	34.50	49.50	1. Rockola World Series	65.00	99.50
6. Circus Romance	195.00	249.50	xx. Rockola Talkie Hrsp.	100.00	125.00
5. Cupid Wheel	90.00	100.00	xx. Rock-O-Ball	75.00	125.00
2. Daval Bumper Bowling	75.00	99.50	5. Roll-A-Ball (Jafco)	379.50	
xx. Daval-U-Roll-It	44.50		6. Scientific Baseball	86.00	99.50
6. Evans Duck Pin Alley	189.50		2. Scientific Batting Pr.	59.00	149.50
xx. Evans In-the-Barrel	75.00	125.00	2. Scientific Basketball	30.00	59.50
2. Evans Super Bomber	235.00	240.00	xx. Scientific Battle Royal	149.50	
1. Evans Play Ball	155.00	175.00	2. Scientific X-Ray Pkr	90.00	100.00
1. Evans Ski Ball	79.50	89.50	5. See-A-Freak	49.50	89.50
6. Evans Ten Strike, LD	30.00	39.50	4. Seeburg Chicken Sam	74.50	139.50
1. Evans Ten Strike, HD	75.00	89.50	2. Seeburg Jap Con	79.50	99.50
2. Evans Tommy Gun	75.00	149.50	2. Seeburg Jail Bird	99.50	100.00
6. Exhibit Bicycle	85.00	125.00	2. Seeburg Shoot-the-Chute	74.50	135.00
xx. Exhibit Basketball	75.00		2. Seeburg Hitler Con	69.50	79.50
6. Exhibit Bowling Alley	59.50	89.50	6. Seeburg Hockey	59.50	69.50
6. Exhibit Hi-Ball	65.00	125.00	4. Seeburg Par. Gun	85.00	89.50
5. Exhibit Merchantman			5. Seeburg Rayolite	25.00	95.00
Roll Ch. Digger	79.50	80.00	6. Selectorscope	169.50	195.00
2. Exhibit Rotary Mdsr	219.50	325.00	xx. Shoot-A-Bazooka (Con)	10.00	
5. Exhibit Vitalizer	69.50	99.50	2. Skee-Barrel Roll	229.00	295.00
2. Genco Bank Roll	195.00	215.00	xx. Star Elec. Hoist Dig	25.00	35.00
xx. Genco Magic Roll	39.50	125.00	5. Super Torpedo	225.00	275.00
2. Genco Play Ball	100.00	125.00	7. Supreme Bolascor	210.00	225.00
5. Genco Total Roll	425.00	525.00	5. Supreme Gun (Rev)	125.00	179.50
6. Groetchen Mtn. Climb	65.00	115.00	1. Supreme Skee Roll	195.00	329.50
2. Groetchen Metal Typer	324.50	349.50	1. Supreme Rocket Buster	149.50	225.00
2. Gottlieb Skee Ballette	49.50	59.50	2. Tail Gunner	47.50	95.00
1. Jenn. Roll-in-the-Bar	125.00	165.00	5. Test Pilot	129.50	195.00
2. Keeney Air Raider	99.50	179.50	xx. Target Roll, 14 Ft.	79.50	
5. Keeney Anti-Aircft. Br.	40.00	69.50	1. Thunderbolt	175.00	225.00
5. Keeney Anti-Aircft. Bl.	30.00	35.00	xx. Tokio Raider (Con)	16.50	16.75
5. Keeney Bowlette	150.00	200.00	xx. Victory Pool (Play Pool)	79.50	100.00
xx. Keeney Navy Bomber	175.00	195.00	xx. Victory Roll	175.00	225.00
2. Keeney Sub Gun	75.00	169.50	5. Warner Voice Recorder	199.50	350.00
1. Keeney Texas League	39.50	59.50	1. Western Baseball '39	89.50	95.00
xx. Kirk Air Defense	115.00	145.00	2. Western Baseball '40	115.00	119.50
5. Kirk Night Bomber	250.00	259.50	4. Western Major League	100.00	149.50
5. Keep Punching	89.50	110.00	1. Western Super Strength	32.00	59.50
xx. Klip-A-Nip Con)	16.50	16.75	xx. Western Recordit	325.00	399.50
7. Kue Ball	25.00	30.00	5. Wurlitzer SkeeBall	195.00	235.00
2. Liberator	149.50	179.50	6. Whee-Gee Mystic	109.50	169.50
			2. Zingo	119.50	125.00

C.M.I. BLUE BOOK



5. All American Derby Con....	\$49.50	\$85.00
xx. All American	25.00	39.50
xx. Arlington	15.00	20.00
xx. Aksaraben, PO	35.00	49.50
xx. Arrowhead	35.00	
xx. Big Game, PO	94.50	95.00
6. Big Prize, FP	39.50	75.00
xx. Big Prize, PO	39.50	
2. Blue Grass, FP	150.00	195.00
xx. Blue Ribbon, PO	40.00	
5. Challenger	80.00	94.50
1. Club Trophy, FP	225.00	339.50
xx. Congo	32.50	
2. Contest, FP	89.50	94.50
2. Dark Horse, FP	150.00	179.50
xx. Derby King	65.00	70.00
xx. Derby Clock, PO	69.50	75.00
xx. Derby Heat, PO	32.50	
xx. Derby Time, PO	65.00	150.00
xx. Derby Winner, PO	100.00	125.00
2. '41 Derby, FP	225.00	339.50
xx. Dust Whirls	275.00	300.00
6. Eureka	25.00	30.00
xx. Feed Bag, PO	50.00	
xx. Flasher, PO	35.00	
xx. Fleetwood	24.50	35.00
xx. Flying Champ	65.00	100.00
1. Fairmount	375.00	475.00
5. Fair Grounds, PO	22.50	49.50
xx. Fast Track	29.50	
xx. Five-in-One, FP	25.00	49.50
5. Fortune, FP	149.50	189.50
xx. Gold Cup, FP	34.50	59.50
2. Grand National, PO	35.00	49.50
5. Grand Stand, PO	47.50	60.00
xx. Gold Medal, PO	25.00	45.00
xx. Hawthorne, PO	50.00	79.50
xx. Hi-Boy, PO	10.00	
xx. Horseshoes, PO	39.50	
2. Jockey Club	285.00	325.00

xx. Jumbo '44	\$79.50	\$90.00
5. Kentucky	129.50	275.00
4. Long Acre	374.50	435.00
5. Long Shot, PO	129.50	250.00
7. One-Two-Three '39, FP	29.50	35.00
6. One-Two-Three '40	60.00	69.50
1. One-Two-Three '41	79.50	85.00
2. Owl, FP	49.50	79.50
xx. Pastime (Rev)	175.00	293.50
6. Preakness, PO	12.50	14.50
6. Pacemaker, PO	50.00	55.00
2. Pimlico, FP	289.50	369.50
xx. Pot Shot	39.50	
5. Race King (Rev)	94.50	125.00
1. Record Time, FP	139.50	174.50
6. Rockingham	179.50	225.00
5. Santa Anita	69.50	110.00
xx. 7 Flasher, FP	79.50	
xx. Sport Event, FP	135.00	
5. Sky Lark, FP & PO	139.50	175.00
1. Sport Special, FP	139.50	175.00
5. Sport Page, PO	29.50	37.50
xx. Spinnig Reels, PO	100.00	110.00
5. Sport King, PO	150.00	239.50
xx. Stepper Upper, PO	65.00	
5. Sportsmen (Rev)	195.00	225.00
6. Track Record	55.00	75.00
6. Thistledown	25.00	55.00
2. Thoroughbred	369.50	374.50
xx. Turf Champ, FP	49.50	52.50
xx. Turf Special	15.00	
2. Turf King	285.00	345.00
5. Victorious 1943 (Rev)	74.50	79.50
xx. Victorious 1944 (Rev)	65.00	84.50
5. Victorious 1945 (Rev)	99.50	109.50
xx. Victory, FP	39.50	47.50
6. Whirlaway (Rev)	249.50	275.00
5. Winning Ticket	65.00	69.50
7. War Admiral (Rev)	125.00	265.00
xx. Zipper	29.50	

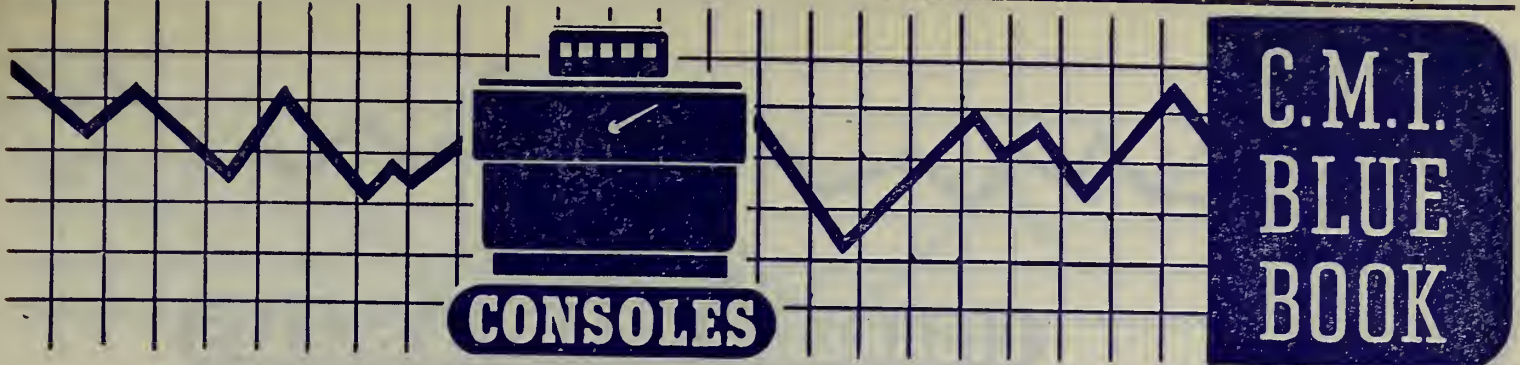

1. 5c Baker's Pacer DD	\$289.50	\$299.50
xx. C.S. Baker's Pacer DD	225.00	375.00
6. 25c Baker's Pacer DD	325.00	450.00
7. 5c Baker's Pacer Std	250.00	279.50
xx. 25c Baker's Pacer Std	350.00	365.00
5. C.S. Baker's Pacer (Standard)	475.00	487.50
xx. Bally Entry	22.50	
5. Bangtails '39	115.00	150.00
xx. Bangtails '40	149.50	199.50
5. Bangtails '41	225.00	295.00
2. Big Game, PO	85.00	189.50
6. Big Game, FP	109.50	119.50
2. Big Top, FP	95.00	99.50
5. Big Top, PO	95.00	109.50
7. Bob Tail, PO	89.50	149.50
5. Bob Tail, FP	99.50	125.00
xx. Buckley, 7 Bells	175.00	289.50
xx. Buckley, Long Shot Par	700.00	
xx. Buckley, Col. Sgt. Head	65.00	
xx. Buckley, Col. New Top	75.00	
xx. Beulah Park	95.00	110.00
xx. Charley Horse	100.00	
xx. China Boy	59.50	
xx. Chucklette	20.00	45.00
1. Club Bells	219.50	295.00
xx. Club Bells 25c	300.00	350.00
xx. Club Chief	89.50	
xx. Club House	50.00	90.00
xx. Derby Day Slant	45.00	75.00
xx. Derby Day Flat	17.20	25.00
xx. Derby Winner	274.50	
xx. Dixie	59.50	
xx. Dominola	35.00	
xx. Double Bells	159.50	199.50
7. Duo Twin Bells 5-25	400.00	450.00
5. Evans Pacers	295.00	319.50
xx. El Dorado	75.00	
5. Exhibit Races	25.00	35.00
xx. Fast Time, FP	50.00	69.50
2. Fast Time, PO	69.50	75.00
xx. Favorite	25.00	
xx. Flashing Thru	95.00	
xx. Flashing Ivories	245.00	
xx. Fleetwood	30.00	
5. Four-Way Super Bell	449.50	495.00
5. Four-Way Bell 3-5 1-25	495.00	595.00
5. Four Horsemen	79.50	149.50
xx. Galloping Domino (38)	45.00	74.50
5. Galloping Domino (39)	110.00	150.00
1. Galloping Domino (40)	149.50	195.00
6. Galloping Domino (41)	225.00	499.50
5. Galloping Domino (42)	275.00	295.00
1. Good Luck	39.50	65.00
2. High Hand	139.50	199.50
xx. Hold & Draw	90.00	
7. Jungle Camp, FP	75.00	99.50
xx. Jungle Camp, PO	69.50	
xx. Jungle Camp, Comb	119.50	125.00
1. Jumbo Parade, Comb	189.50	225.00
2. Jumbo Parade, FP	60.00	129.50
1. Jumbo Parade, PO	89.50	150.00
6. Jumbo Parade, 25c	195.00	200.00
5. Kentucky Club	89.50	125.00
xx. Keen Kubes	129.50	
xx. Kennette	89.50	
xx. Keno	40.00	
6. Liberty Bell	19.50	50.00
1. Long Champs	60.00	79.50
xx. Lucky Lucre	99.50	105.00
2. Lucky Lucre '41	125.00	195.00
5. Lucky Lucre 5-25	295.00	
5. Lucky Lucre 5-5	150.00	195.00
5. Lucky Star	100.00	139.50
xx. Lucky Star '41	295.00	
xx. Lincoln Field	95.00	149.50
5. May Bells 5-5-5-25c	295.00	395.00
xx. Multiple Cubes, PO	30.00	47.50
5. Multiple Racer	35.00	95.00

2. Mills 4 Bells	\$265.00	\$695.00
2. Mills 3 Bells	775.00	875.00
5. Mills Auto Dice 25c	39.50	150.00
xx. Pace Century	300.00	350.00
xx. Pace Marathon	99.50	
2. Paces Races Bl. Cab.	59.50	75.00
2. Paces Races Br. Cab.	175.00	195.00
xx. Paces Races Red Arrow	124.50	150.00
xx. Paces '39 Saratoga	47.50	79.50
6. Paces '40 Saratoga	129.50	169.50
1. Paces Saratoga w. rails	95.00	110.00
5. Paces Saratoga, no rails	75.00	79.50
5. Paces Saratoga Comb	119.00	239.50
2. Paces Saratoga Jr. PO	75.00	99.50
7. Paces Saratoga, Sr.	169.50	189.50
5. Paces Reels Comb	150.00	164.50
5. Paces Reels, Jr. PO	75.00	90.00
4. Paces Reels, Sr. PO	99.50	125.00
5. Paces Reels, with rails	89.50	125.00
5. Paces Reels, no rails	69.50	79.50
2. Paces Twin 5-10	195.00	245.00
5. Paces Twin Console 5-25	225.00	395.00
5. Pastime	195.00	219.50
xx. Paddock Club	50.00	
xx. Pamco DeLuxe Bell	17.50	45.00
xx. Parlay Races	35.00	49.50
xx. Pay Day	149.50	225.00
xx. Pheasant	6.00	
xx. Pickem	22.50	
xx. Ray's Track	40.00	75.00
6. Rio	25.00	
5. Riviera	150.00	279.50
xx. Rollette, Jr.	40.00	60.00
xx. Rollette, Jr. (41)	125.00	
xx. Rollette, Sr.	490.00	499.50
xx. Rosemount	25.00	
xx. Royal Draw	60.00	105.00
xx. Royal Flush	50.00	69.50
xx. Royal Lucre '41	275.00	290.00
5. Roll 'em	89.50	139.50
xx. Roulette 25c Caille	250.00	275.00
xx. Seeburg Races	35.00	
xx. Saddle Club	35.00	47.50
xx. Silver Bell	29.50	32.50
xx. Silver Moon, Comb	140.00	155.00
2. Silver Moon, PO	74.50	129.50
1. Silver Moon, FP	99.50	125.00
xx. Silver Moon, 10c	159.50	269.50
5. Silver Moon, 25c	219.50	225.00
5. Skill Field	89.50	
xx. Skillo	180.00	
xx. Skill Time '37	39.50	
xx. Skill Time '38	50.00	59.50
xx. Skill Time '41	65.00	110.00
5. Square Bell	50.00	85.00
xx. Stanco Bell Double	119.50	
xx. Stanco Bell Single	110.00	
xx. Sugar King	25.00	50.00
6. Sun Ray	139.50	145.00
1. Super Bell 5c Comb	265.00	325.00
5. Super Bell 25c Comb	345.00	375.00
7. Super Track Time	225.00	249.50
xx. Super Track Time TKT	260.50	
xx. Suzie Q	75.00	
xx. Tanforan	25.00	44.50
xx. Track King	25.00	
xx. Track Meet	159.50	
xx. Track Odds, West	100.00	
1. Track Odds, Buckley	150.00	395.00
5. Track Odds, Daily Dbl.	475.00	479.50
1. Track Odds, DD, JP, Buckley	650.00	795.00
xx. Track Odds, DD, JP, Buckley (New)	995.00	
7. Track Time '39	100.00	200.00
5. Track Time '38	75.00	125.00
xx. Track Time '37	39.50	79.50
xx. Track Time '38 TKT	75.00	
xx. Track Time '37 TKT	35.00	49.50
5. Triple Entry	69.50	159.50
2. Two-Way Super Bell 5-5	295.00	595.00
1. Two-Way Super Bell 5-25	395.00	595.00

C.M.I. BLUE BOOK

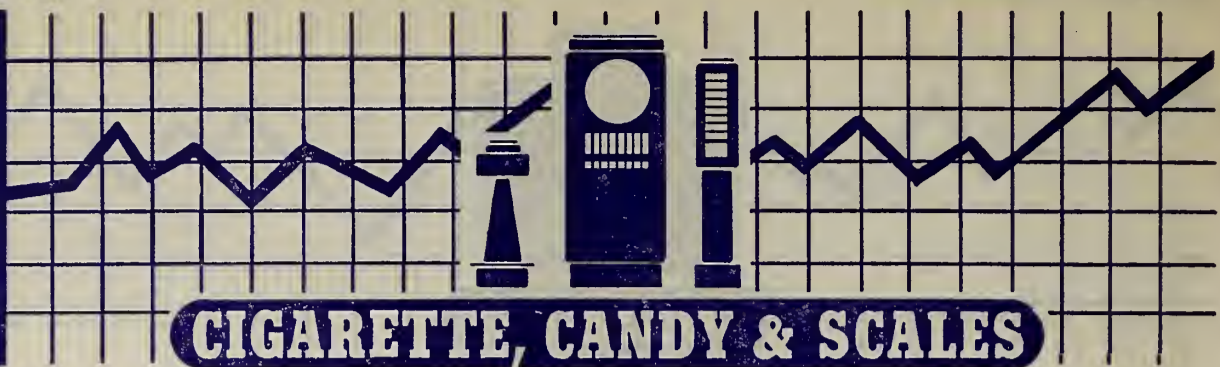

CIGARETTE, CANDY & SCALES

CIGARETTE

DU GRENIER

2. Model S 7 Column	\$40.00	\$49.50
5. Model VD 7 Column	25.00	64.50
xx. Model W 9 Column	30.00	69.50
xx. Model WD 9 Column	70.00	74.50
5. Champion, 11 Column King Size	95.00	104.50
5. Champion, 9 Column	89.50	97.50
1. Champion, 7 Column	77.50	95.00

NATIONAL

xx. Model 9-50	50.00	59.50
xx. Model 7-50, Regular	42.50	
xx. Model 7-50, King Size	42.50	47.50
xx. Model 9-30	30.00	40.00
xx. Model 9A	65.00	79.50
xx. Model 6-30	22.50	29.50
xx. Model 6-26	15.00	

ROWE

xx. Aristocrat, 6 Column	7.50	
xx. Imperial, 6 Col.	15.00	50.00
xx. Imperial, 8 Col.	25.00	60.00
xx. Royal, 6 Col.	35.00	45.00
xx. Royal, 8 Col.	45.00	65.00
1. Royal, 10 Col.	45.00	92.50
xx. President, 6 Col.	45.00	
xx. President, 8 Col.	55.00	
xx. President, 10 Col.	65.00	85.00

U-NEED-A-PAK

xx. Model E, 6 Col.	10.00	
xx. Model E, 8 Col.	10.00	20.00
xx. Model, 9 Col.	25.00	
xx. Model E, 12 Col.	35.00	
xx. Model E, 15 Col.	45.00	
xx. Model A, 8 Col.	30.00	45.00
xx. Model A, 9 Col.	35.00	50.00
7. Model 500, 7 Col.	60.00	92.50
5. Model 500, 9 Col.	59.50	100.00
7. Model 500, 15 Col.	75.00	112.50

CANDY

DU GRENIER

xx. Candy Man	\$39.50	\$45.00
---------------------	---------	---------

NATIONAL

xx. Model 618, 6 Column	50.00	
xx. Model 918, 9 Column Regular	60.00	
xx. Model 918, 9 Column Special	85.00	100.00

ROWE

xx. 8 Column Standard	45.00	
xx. 8 Column DeLuxe	85.00	
xx. 8 Column 1c Gum & Mint..	12.50	
xx. 8 Column 5c Gum & Mint..	16.50	

U-NEED-A-PAK

xx. 5 Column	40.00	69.50
--------------------	-------	-------

U-SELECT-IT

xx. 54 Bars	15.00	22.50
xx. 72 Bars	20.00	

STONER

xx. 6 Column	55.00	
xx. 8 Column	65.00	

SCALES

WATLING

xx. Tom Thumb, Plain	47.50	60.00
6. Tom Thumb, Fortune	75.00	89.50
xx. 500 Fortune	90.00	100.00
6. Hi-Boy Guesser	69.50	100.00

JENNINGS

xx. Junior	25.00	
xx. Lo Boy	49.50	

PEERLESS

xx. Lo Boy	37.50	50.00
------------------	-------	-------

MILLS

7. Lo Boy	40.00	50.00
-----------------	-------	-------

PACE

7. Lo Boy	40.00	49.50
-----------------	-------	-------

IDEAL

xx. Lo Boy	42.50	
------------------	-------	--

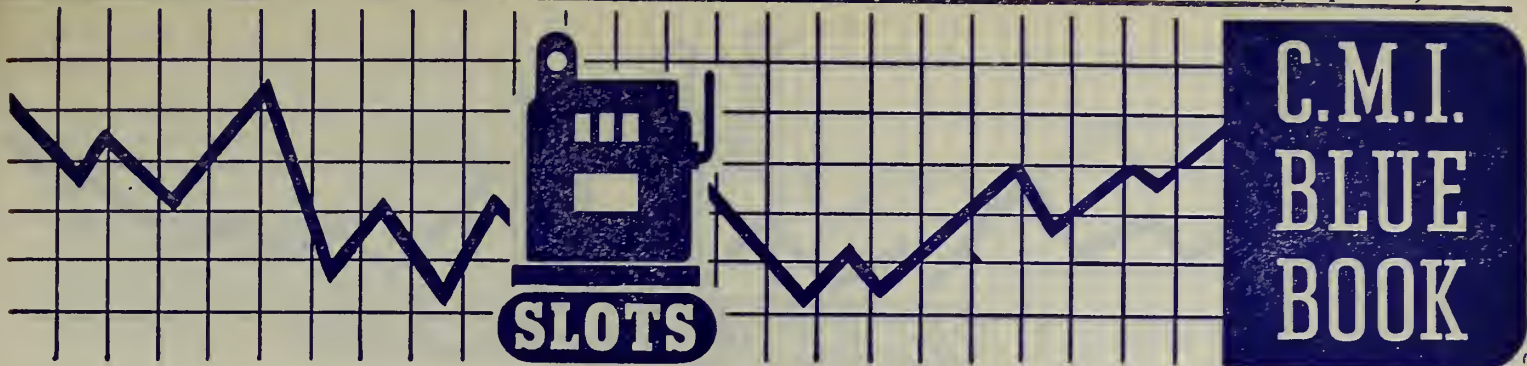

MILLS

5. 5c Black, HL	\$165.00	\$190.00
xx. 10c Black	250.00	
xx. 25c Black, HL	275.00	
xx. 5c Emerald Chrome, HL	225.00	299.50
xx. 10c Emerald Chrome, HL	275.00	
xx. 25c Emerald Chrome, HL	450.00	
xx. 50c Emerald Chrome, HL	625.00	675.00
xx. 5c Gold Chrome, HL	345.00	450.00
xx. 10c Gold Chrome, HL	495.00	
xx. 25c Gold Chrome, HL	575.00	
xx. 50c Gold Chrome, HL	375.00	625.00
1. 5c Gold Chrome	150.00	225.00
5. 10c Gold Chrome	175.00	185.00
2. 25c Gold Chrome	195.00	225.00
xx. 50c Gold Chrome	450.00	475.00
7. 5c Copper Chrome	205.00	
7. 10c Copper Chrome	210.00	
5. 25c Copper Chrome	225.00	
7. 5c Club Bell	225.00	300.00
7. 10c Club Bell	250.00	325.00
7. 25c Club Bell	275.00	350.00
7. 50c Club Bell	800.00	900.00
xx. 1c Blue Front	100.00	150.00
1. 5c Blue Front	115.00	135.00
<hr/>		
2. 10c Blue Front	129.50	169.50
<hr/>		
1. 25c Blue Front	160.00	250.00
<hr/>		
7. 50c Blue Front	395.00	400.00
xx. 1c Brown Front	180.00	195.00
1. 5c Brown Front	125.00	180.00
<hr/>		
2. 10c Brown Front	145.00	179.50
4. 25c Brown Front	175.00	225.00
2. 50c Brown Front	375.00	395.00
xx. 1c Cherry Bell	90.00	165.00
2. 5c Cherry Bell	139.50	140.00
5. 10c Cherry Bell	150.00	165.00
5. 25c Cherry Bell	175.00	195.00
xx. 1c Bonus Bell	289.50	
2. 5c Bonus Bell	150.00	159.50
7. 10c Bonus Bell	245.00	250.00
7. 25c Bonus Bell	250.00	275.00
4. 5c Original Chrome	179.50	200.00
5. 10c Original Chrome	175.00	225.00
5. 25c Original Chrome	209.50	250.00
2. 50c Original Chrome	395.00	425.00
7. 1c Q.T. Blue	42.50	50.00
7. 5c Q.T. Blue	75.00	79.50
7. 10c Q.T. Blue	65.00	100.00
7. 25c Q.T. Blue	100.00	125.00
xx. 1c Q.T. Green	25.00	35.00
xx. 5c Q.T. Green	39.50	60.00
xx. 10c Q.T. Green	65.00	69.50
xx. 5c Q.T., F.P.	49.50	
7. 1c Q.T. Glitter Gold	50.00	75.00
1. 5c Q.T. Glitter Gold	89.50	109.50
7. 10c Q.T. Glitter Gold	79.50	125.00
xx. 1c V.P. Bell	29.50	
xx. 1c V.P. Bell, JP	37.50	
xx. 1c Bell, Green	22.50	
1. 5c V.P. Bell, Green	32.50	42.50
xx. 1c V.P. Chrome	40.00	
2. 5c V.P. Chrome	49.50	55.00
xx. 5c V.P. Chrome, Plus	55.00	65.00
xx. 1c V.P. Bell, B&G	32.50	
1. 5c V.P. Bell, B&G	49.50	55.00
5. 5c Futurity	99.50	125.00
xx. 10c Futurity	110.00	189.50
xx. 25c Futurity	110.00	200.00
xx. 50c Futurity	194.50	
xx. 5c Yellow Front	69.50	72.50
xx. 5c Black Cherry Bell	200.00	250.00
xx. 10c Black Cherry Bell	210.00	275.00

xx. 25c Black Cherry Bell	\$215.00	\$285.00
xx. 10c Yellow Front	135.00	
xx. 25c Yellow Front	150.00	
xx. 1c Smoker Bell	35.00	
6. 5c Smoker Bell	39.50	50.00
6. 5c F.P. Mint Vendor	35.00	85.00
2. 25c Golf Ball Vendor	140.00	200.00
6. 5c War Eagle	69.50	150.00
xx. 10c War Eagle	85.00	149.50
1. 25c War Eagle	109.50	165.00
5. 50c War Eagle	365.00	395.00
xx. 5c Red Front	90.00	125.00
xx. 10c Red Front	150.00	
xx. 25c Red Front	145.00	275.00
xx. 5c F.O.K.	15.00	17.50
6. 5c Roman Head	95.00	125.00
xx. 10c Roman Head	100.00	175.00
xx. 25c Roman Head	124.50	200.00
5. 50c Roman Head	250.00	345.00
xx. 1c Skyscraper	40.00	
6. 5c Skyscraper	59.50	85.00
xx. 10c Skyscraper	64.50	85.00
xx. 25c Skyscraper	69.50	89.50
xx. 50c Skyscraper	250.00	
xx. 1c Lion Head	30.00	
xx. 5c Lion Head	40.00	54.50
5. 5c Extraordinary	99.50	125.00
5. 10c Extraordinary	115.00	150.00
5. 25c Extraordinary	145.00	175.00
xx. 50c Extraordinary	400.00	449.50
2. 5c Melon Bell	125.00	135.00
6. 10c Melon Bell	150.00	
6. 25c Melon Bell	135.00	175.00
xx. 5c Wolf Head	34.50	49.50
xx. 10c Wolf Head	49.50	57.50
xx. 25c Wolf Head	50.00	70.00
xx. 1c Shamrock Bell	27.50	
xx. 5c Slugproof 3-5	124.50	

WATLING

5. 1c Rolatop	10.00	15.00
1. 5c Rolatop	75.00	95.00
<hr/>		
1. 10c Rolatop	60.00	135.00
<hr/>		
5. 25c Rolatop	85.00	150.00
5. 50c Rolatop	190.00	195.00
xx. 5c Club Bell	110.00	175.00
5. 10c Club Bell	75.00	175.00
xx. 25c Club Bell	215.00	275.00
2. 1c Twin JP	25.00	29.50
xx. 5c Twin JP	25.00	49.50
xx. 25c Twin JP	55.00	69.50
xx. 1c Blue Seal	22.50	
5. 5c Blue Seal	25.00	30.00
xx. 10c Blue Seal	52.50	60.00
5. 25c Blue Seal	29.50	39.50
xx. 1c Treasury	10.00	20.00
7. 5c Treasury	32.50	40.00
2. 10c Treasury	32.50	35.00
xx. 25c Treasury	80.00	109.50
xx. 5c Wonder Vendor	64.50	
xx. 5-25 Rolatop	49.50	

GROETCHEN

xx. 5c Columbia Chrome	94.50	95.00
xx. 1c Columbia	69.50	
xx. 5c Columbia JPV Bell	35.00	44.50
1. 5c Columbia Fruit	39.50	89.50
xx. 5c Columbia Cig RJ	59.50	69.50
6. 5c Columbia DJP	35.00	85.00
xx. 10c Columbia DJP	45.00	79.50
xx. 10c Columbia Club DJ	75.00	
xx. 5c Columbia Club Cig GA	44.50	65.00
xx. 10c Columbia Club Cig GA	59.60	69.50
5. 5c Columbia Cig GA	45.00	54.50
6. 5c Columbia Fruit GA	69.50	89.50
2. Columbia Orig. GA	69.50	72.50
5. Conv. Columbia Chrome	79.50	82.50

C.M.I. BLUE BOOK



P A C E

xx. 1c Bantam	\$20.00	\$27.50
xx. 5c Bantam	19.50	24.50
xx. 10c Bantam	34.50	
5. 25c Bantam	39.50	50.00
2. 5c Comet, FV	49.50	60.00
2. 10c Comet, FV	65.00	67.50
2. 25c Comet, FV	79.50	85.00
xx. 50c Comet, FV	98.50	125.00
xx. 5c Comet, DJP	40.00	75.00
xx. 10c Comet, DJP	50.00	79.50
xx. 1c Comet, Blue	45.00	
xx. 5c Comet, Blue	50.00	60.00
xx. 10c Comet, Blue Front	50.00	75.00
xx. 25c Comet, Blue Front	90.00	94.50
xx. 50c Comet	295.00	300.00
6. 5c All Star Comet	65.00	79.50
2. 10c All Star Comet	65.00	69.50
6. 25c All Star Comet	90.00	125.00
6. 50c All Star Comet	275.00	350.00
xx. 1c All Star 2-4	35.00	39.00
xx. 1c Rocket	149.50	
6. 5c Rocket	94.50	95.00
6. 10c Rocket	110.00	119.50
xx. 25c Rocket	125.00	139.50
xx. 5c T.J. Comet	47.50	
7. 5c Club Bell	75.00	95.00
xx. 25c Club Bell	125.00	150.00
7. 50c Club Bell	295.00	300.00
5. 1c DeLuxe	55.00	
6. 5c DeLuxe	94.50	95.00
6. 10c DeLuxe	110.00	119.50
xx. 25c DeLuxe	120.00	140.00
xx. Double Slot 5c-25c	395.00	
xx. 5c Comet Console	125.00	139.50
xx. 10c Comet Console	159.50	
xx. 25c Comet Console	169.50	
7. 5 & 25c Comet Con. Comb.	195.00	225.00
xx. 5c Kitty	70.00	75.00
xx. 10c Kitty	35.00	85.00
xx. 25c Kitty	210.00	
xx. 5c Comet Red	90.00	125.00
xx. 10c Comet Red	120.00	
xx. 5c Slugproof	97.50	100.00
2. 10c Slugproof	95.00	100.00
xx. 25c Slugproof	125.00	165.00

CAILLE

xx. 1c	39.00	39.50
6. 5c	35.00	50.00
5. 10c	35.00	60.00
5. 25c	89.50	99.50
xx. 5c & 25c	275.00	
6. 5c Cadet	37.50	50.00
xx. 10c Cadet	95.00	125.00
xx. 25c Cadet	89.50	105.00
xx. 5c Playboy	49.50	75.00
xx. 10c Playboy	49.50	85.00
xx. 25c Playboy	60.00	
xx. 5c Commander	35.00	55.00
xx. 10c Commander	50.00	65.00
xx. 25c Commander	65.00	74.50
xx. 7-Way Slot 5c	49.50	65.00
xx. 7-Way Slot 25c	98.00	250.00
xx. 5c Doughboy	49.50	
xx. 5c Club Bell	40.00	75.00
xx. 10c Club Bell	75.00	85.00
xx. 25c Club Bell	100.00	125.00

JENNINGS

5. 5c Chief	\$125.00	\$140.00
6. 10c Chief	90.00	125.00
xx. 25c Chief	129.50	175.00
7. 50c Chief	295.00	450.00
5. 5c Silver Moon Chief	125.00	149.50
6. 10c Silver Moon Chief	135.00	200.00
xx. 25c Silver Moon Chief	195.00	250.00
2. 5c Silver Chief	139.50	149.50
1. 10c Silver Chief	150.00	159.50
5. 25c Silver Chief	175.00	225.00
xx. 50c Silver Chief	550.00	650.00
2. 5c Club Bell	129.50	139.50
4. 10c Club Bell	150.00	159.50
2. 25c Club Bell	175.00	249.50
xx. 50c Club Bell	350.00	
1. 5c Sky Chief	125.00	139.00
5. 10c Sky Chief	159.50	189.50
xx. 25c Sky Chief	200.00	
xx. Triplex Chief 5-10-25	100.00	
xx. 1c Little Duke	12.50	17.50
xx. 5c Little Duke	125.00	
xx. 10c Little Duke	20.00	65.00
xx. 5c Century	35.00	55.00
xx. 10c Century	49.50	69.50
xx. 25c Century	50.00	
5. 50c Century	295.00	
6. 5c Gooseneck	29.50	35.00
xx. 10c Gooseneck	35.00	59.50
6. 25c Gooseneck	55.00	60.00
xx. 50c Gooseneck	150.00	
xx. 1c Little Duchess	20.00	29.50
xx. 5c Little Duchess	25.00	30.00
1. 10c Golf Ball Vndr	75.00	200.00
1. 25c Golf Ball Vndr	69.50	200.00
xx. 5c Chrome Cup Chief	175.00	
xx. 10c Chrome Chief SP	152.00	
xx. 5c Red Skin	125.00	145.00
xx. 10c Red Skin	135.00	149.50
xx. 25c Red Skin	150.00	
6. 5c Big Chief	90.00	115.00
xx. 10c Big Chief	165.00	
xx. 25c Big Chief	199.50	
5. \$1.00 Bell	595.00	695.00
5. Cigarolla	59.50	60.00
7. Cigarolla XXV	89.50	129.50
xx. Cigarolla XV	75.00	79.50
5. 5c Victory Chief	119.50	124.50
xx. 10c Victory Chief	155.00	195.00
xx. 25c Victory Chief	200.00	385.00
xx. 1c 4 Star Chief	79.50	110.00
4. 5c 4 Star Chief	95.00	135.00
1. 10c 4 Star Chief	100.00	165.00
5. 25c 4 Star Chief	150.00	175.00
xx. 1c Dixie Bell	35.00	
2. 5c Dixie Bell	75.00	89.50
7. 10c Dixie Bell	60.00	75.00
xx. 25c Dixie Bell	295.00	
7. 50c Dixie Bell	385.00	404.50
xx. 5c Victory 4 Star Ch	350.00	
xx. 10c Victory 4 Star Ch	225.00	
xx. 25c Victory 4 Star Ch	350.00	

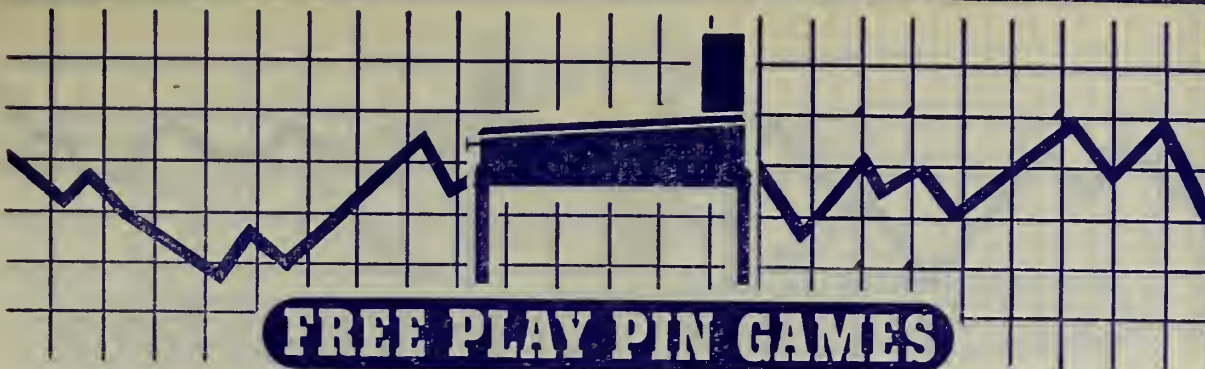

FREE PLAY PIN GAMES

**C.M.I.
BLUE
BOOK**

1. A. B. C. Bowler	\$49.50	\$79.50	2. Cross Line	\$39.50	\$69.50
5. Action (Rev)	99.50	149.50	5. Crystal	34.50	45.00
1. Air Circus	124.50	140.00	xx. Crystal Gazer	26.50	
1. Air Force	79.50	85.00	xx. Dandy	19.00	27.50
xx. Airliner	15.00	27.50	1. Daily Dozen	10.00	25.00
5. Airport	17.50	25.00	6. Davy Jones	15.00	20.00
xx. Alert (Rev)	59.50	75.00	5. Defense (Baker)	32.50	35.00
xx. Ali Baba	29.50		1. Defense (Genco)	84.50	105.00
2. All American	49.50	65.00	xx. De-Icer (Rev)	79.50	
xx. All Out (Rev)	59.50		xx. Destroyer (Rev)	69.50	79.50
5. American Beauty (Rev)	99.50	129.50	xx. Dive Bomber (Rev)	39.50	
2. Anabel	25.00	35.00	4. Dixie	20.00	52.50
5. Arizona (Rev)	199.50	249.50	2. Do-Re-Mi	50.00	60.00
2. Armada	19.50	25.00	1. Double Feature	25.00	40.00
2. Argentine	65.00	80.00	2. Double Play	55.00	60.00
xx. Arrowhead	19.50	50.00	1. Doughboy	29.50	47.50
5. Attention	50.00	60.00	1. Drum Major	25.00	50.00
xx. Avalon	15.00	27.50	4. Dude Ranch	34.50	59.50
xx. Airway	22.50		1. Duplex	60.00	79.50
1. Bally Beauty	22.50	64.50	1. Eagle Squadron (Rev)	89.50	145.00
xx. Banner	17.50		xx. Entry	39.50	40.00
1. Bandwagon	49.50	50.00	6. Eureka	25.00	34.50
5. Bang	12.50	30.00	xx. Falling Sun (Rev)	59.50	
2. Barrage	37.50	39.50	xx. Fantasy	30.00	45.00
xx. Battle	87.50	100.00	1. Fifth Inning	42.50	44.50
2. Belle Hop	40.00	79.50	xx. Fifty Grand	29.50	
5. Big Chief	42.50	65.00	7. Fishin' (Rev)	55.00	74.50
2. Big League	22.50	30.00	7. Five-in-One	25.00	45.00
2. Big Parade	85.00	139.50	2. Five & Ten & Twenty	99.50	145.00
xx. Big Show	19.00	30.00	5. Flagship	16.95	30.00
xx. Big Ten	27.50		5. Flat Top (Rev)	205.00	269.50
7. Big Six	19.00	27.50	2. Fleet	35.00	49.50
1. Big Three (Rev)	149.50	179.50	1. Flicker	55.00	82.50
5. Big Time	40.00	44.50	9. Flying Tiger	99.50	110.00
5. Big Top	104.50	249.50	1. Follies '40	30.00	49.50
xx. Big Town	21.50	40.00	5. Follow Up	17.50	20.00
xx. Blackout	15.00	35.00	5. Foreign Colors	109.50	169.50
7. Blondie	20.00	25.00	xx. Formation	20.00	25.00
4. Bombardier (Rev)	84.50	110.00	1. Four Aces	129.50	145.00
5. Bola Way	69.50	89.50	2. Four Diamonds	25.00	69.50
xx. Bomb-the-Axis	50.00	64.50	xx. Four-Five-Six	15.00	22.50
1. Boomtown	29.50	39.50	1. Four Roses	49.50	75.00
xx. Bordertown	24.50	40.00	2. Fox Hunt	29.50	49.50
1. Bosco	75.00	92.50	xx. Flash	18.50	23.50
xx. Bounty	12.00	25.00	5. G. I. Joe (Conv)	60.00	89.50
xx. Bowling Alley	20.00	35.00	5. Girls Ahoy (Rev)	42.50	69.50
xx. Box Score	12.50		5. Glamour	32.50	65.00
5. Brazil (Rev)	194.50	249.50	5. Gobs	95.00	129.50
xx. Brite Spot	22.50	59.50	1. Gold Star	39.50	54.50
1. Broadcast	45.00	69.50	5. Golden Gate	15.00	17.50
xx. Buckaroo	15.00	19.50	2. Grand Canyon (Rev)	194.50	210.00
5. Capt. Kidd	69.50	89.50	2. Gun Club	65.00	80.00
1. Cadillac	29.50	47.50	xx. Headliner	20.00	39.50
xx. Canteen	149.50	190.00	xx. Hi-Boy (Rev)	45.00	60.00
xx. Casablanca (Rev)	179.50	225.00	2. Hi-Dive	84.50	95.00
5. Catalina	249.50		4. Hi-Hat	70.00	85.00
1. Champ	40.00	69.50	xx. High Light	18.95	
1. Champion	12.50	44.50	1. High Stepper	34.50	50.00
xx. Charm	39.50		1. Hit-the-Jap (Rev)	34.50	74.50
1. Chevron	19.50	47.50	xx. Hold Over	29.50	39.50
xx. Chief	15.00		2. Hollywood	245.00	249.50
xx. Chubbie	17.50	49.50	1. Home Run '40	30.00	44.50
xx. Circus	25.00		5. Home Run '41	49.50	69.50
5. Click	74.50	79.50	2. Home Run '42	69.50	74.50
xx. Clipper	25.00		5. Horoscope	50.00	75.00
2. Clover	20.00	49.50	1. Idaho	245.00	249.50
xx. C. O. D.	15.00	22.50	1. Invasion (Rev)	99.50	129.50
xx. Commander (Rev)	50.00	55.00	1. Jolly	15.00	47.50
xx. Commodore	24.50		1. Jeep (Rev)	99.50	122.50
2. Congo	24.50	25.00	xx. Jumper	25.00	29.50
5. Conquest	17.50	25.00	4. Jungle	72.00	80.00
5. Contact	15.00	17.50	1. Keep 'em Flying	139.50	169.50
7. Contest	94.50	99.50	xx. Keen-A-Ball	24.50	35.00
xx. Convention	20.00	32.50	2. Kismet	169.50	249.50
2. Cowboy	19.00	25.00	xx. Klick	15.00	22.50
7. Cover Girl	125.00	179.50			

C.M.I. BLUE BOOK



FREE PLAY PIN GAMES

2. KnockOut	\$75.00	\$129.50
xx. Knock-Out-the-Jap	75.00	105.00
xx. Lancer	25.00	39.50
1. Landslide	42.50	64.50
5. Laura	249.50	
1. Lead Off	25.00	55.00
5. Leader	60.00	69.50
1. League Leader	49.50	50.00
2. Legionnaire	35.00	79.50
5. Liberty	130.00	175.00
xx. Liberty (Rev)	55.00	87.50
1. Limelight	29.50	47.50
xx. Line Up	20.00	49.50
5. Lite-A-Card	25.00	50.00
2. Lone Star	27.50	40.00
xx. Lot-O-Smoke	25.00	
xx. Lot-O-Fun	15.00	20.00
1. Lucky	20.00	59.50
xx. Majors '40	12.50	17.50
1. Majors '41	40.00	82.50
xx. Mardi Gras	40.00	
1. Marines-at-Play	99.50	145.00
1. Marvels Baseball	90.00	145.00
5. Mascot	30.00	44.50
5. Merry-Go-Round	27.50	44.50
5. Metro	45.00	60.00
xx. Miami	15.00	
2. Miami Beach	65.00	80.00
xx. Midway (Genco)	12.50	15.00
4. Midway (Rev)	109.50	175.00
xx. Miss America (Rev)	35.00	42.50
7. Mr. Chips	19.00	25.00
1. Monicker	79.50	105.00
1. Mystic	45.00	60.00
1. New Champ	75.00	89.50
xx. Nippy	19.50	39.50
7. Nite Club (Rev)	79.50	84.50
xx. Ocean Park	12.00	24.50
1. Oh Boy	16.50	25.00
xx. Oh Johnny	25.00	35.00
1. On Deck	22.50	29.50
5. Oklahoma	239.50	249.50
1. One-Two-Three '39	32.50	40.00
5. One-Two-Three '40	59.50	79.50
1. One-Two-Three '41	69.50	85.00
1. Owl	49.50	89.50
xx. Pals	21.50	
5. Paratroop (Rev)	89.50	105.00
5. Pan American	45.00	69.50
1. Paradise	45.00	69.50
xx. Parade Leader (Rev)	34.50	39.50
xx. Pep (Rev)	29.50	
5. Pick 'Em	15.00	44.50
2. Play Ball	39.50	69.50
1. Pin Up Girl	90.00	145.00
xx. Playmate	29.50	39.50
6. Playtime (Rev)	51.50	52.50
5. Polo	15.00	22.50
xx. Pot Shot	25.00	39.50
1. Powerhouse	39.50	40.00
5. Production (Rev)	59.50	109.50
2. Progress	22.50	27.50
xx. Punch	16.50	22.50
xx. Pursuit	37.50	49.50
5. Pylon	22.50	29.50
xx. Pyramid	12.50	
xx. Ragtime	15.00	29.50
xx. Rats (Rev)	47.50	
xx. Rebound	15.00	22.50
xx. Record Breaker	150.00	
6. Red Hot	15.00	19.00
2. Red, White & Blue	21.00	29.50
7. Repeater	29.50	39.50
xx. Reserve	10.00	20.00
xx. Rink	15.00	19.00
xx. Roll Call (Rev)	45.00	69.50
xx. Roller Derby	39.50	44.50
2. Rotation	22.50	25.00
xx. Rotor Table	79.50	89.50
5. Roxy	20.00	29.50
5. Salute	29.50	49.50
2. Santa Fe (Rev)	199.50	249.50
2. Sara Suzy	25.00	27.50
xx. Scandals (Rev)	35.00	
4. School Days	49.50	70.00
5. Scoop	20.00	29.50
1. Score-A-Line	29.50	50.00
2. Score-A-Card	20.00	25.00
5. Score Champ	25.00	44.50
xx. Scout (Rev)	29.50	
xx. Sea Power (Rev)	67.50	
4. Sea Hawk	49.50	70.00
6. Second Front (Rev)	65.00	135.00

2. Seven Up	\$49.50	\$70.00
1. Shangri La	79.50	135.00
5. Short Stop	29.50	44.50
2. Show Boat	49.50	79.50
xx. Side Kick	15.00	
1. Silver Skates	40.00	45.00
5. Silver Spray	32.50	34.50
1. Sink-the-Jap (Rev)	45.00	79.50
xx. Sixty Grand	17.50	
2. Sky Blazer	34.50	60.00
4. Sky Chief	160.00	175.00
2. Sky Line	39.50	54.50
2. Sky Ray	25.00	27.50
1. Sky Raider (Rev)	129.50	155.00
1. Slap-the-Jap	35.00	74.50
5. Slugger	70.00	72.50
2. Smak-the-Jap (Rev)	35.00	79.50
2. Snappy '41	35.00	79.50
2. South Paw	64.50	89.50
5. South Seas	269.50	279.50
5. Sparky	24.50	44.50
5. Speed Ball	35.00	54.50
1. Speed Demon	17.50	49.50
1. Speedway	20.00	49.50
xx. Speedy	24.50	29.50
7. Sports	20.00	25.00
4. Sports Parade	40.00	57.50
xx. Stop & Go	29.50	35.00
5. Sporty	15.00	25.00
1. Spot-A-Card	72.50	95.00
7. Spot-Cha (Rev)	79.50	89.50
4. Spot Pool	55.00	82.50
5. Spottem	20.00	44.50
5. Stage Door Canteen	249.50	
1. Stars	60.00	74.50
2. Star Attraction	35.00	79.50
2. Stratoliner	35.00	60.00
2. Streamliner	179.50	249.50
6. Strip Tease (Con)	104.50	110.00
5. Summertime	20.00	25.00
2. Sun Beam	55.00	60.00
xx. Supercharger	17.50	27.50
5. Super Chubbie	39.50	79.50
2. Super Six	29.50	37.50
5. Sun Valley (Rev)	125.00	135.00
5. Tail Gunner (Con)	49.50	69.50
6. Target Skill	10.00	22.50
1. Ten Spot	49.50	79.50
1. Texas Mustang	62.50	90.00
5. Three Score	32.50	35.00
6. Three Up	24.50	34.50
5. Thriller	19.50	20.00
1. Thumbs Up (Rev)	60.00	74.50
1. Topic	79.50	95.00
7. Top Notcher	15.00	24.50
xx. Topper	25.00	35.00
1. Torpedo Patrol (Rev)	79.50	119.50
5. Towers	74.50	99.50
1. Trade Wind (Rev)	225.00	259.50
2. Trailways	59.50	70.00
7. Trapeze	17.50	24.50
xx. Triumph	15.00	35.00
xx. Triple Play	17.50	
5. Twinkle	15.00	44.50
2. Twin Six	20.00	45.00
5. Ump	25.00	27.50
xx. Up & Up	34.50	
2. Vacation	24.50	25.00
xx. Variety	12.50	15.00
4. Velvet	30.00	79.50
4. Venus	79.50	92.50
1. Victory	89.50	125.00
xx. Vogue	15.00	27.50
2. Wagon Wheels	249.50	259.50
1. West Wind	60.00	75.00
xx. White Sails	15.00	29.50
2. Wild Fire	30.00	59.50
6. Wings	11.50	49.50
2. Wow	27.50	34.50
xx. Yacht Club	15.00	17.50
4. Yankee Doodle	125.00	225.00
1. Yanks	95.00	125.00
xx. Zenith	95.00	
1. Zeta	19.50	35.00
2. Zig Zag	55.00	80.00
xx. Zip	15.00	25.00
5. Zombie	60.00	79.50

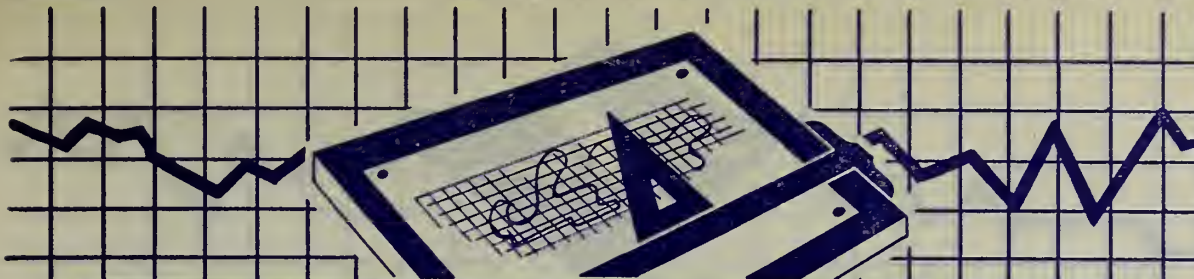

**C.M.I.
BLUE
BOOK**

MANUFACTURERS' NEW EQUIPMENT

MUSIC

A.M.I.	
Model A	\$695.00
AIREON	
Fiesta	
Artisan	
Electronic Phono	
Trio (Wall Box)	
Solo (Wall Box)	
Melodeon (Speaker)	
Impresario (Speaker)	
Carillon (Speaker)	
CHALLENGE INDUSTRIES	
Challenger '47	
ROCKOLA	
#1422—Phonograph	\$595.00
SEEBURG	
#1—46M	
#1—46S	
WURLITZER	
#1015	
#3020—5-10-25c 3-wire Wall Box	
#3021—5c Wall Box	
#3031—5c 30-Wire Wall Box.. ..	
#4000—Speaker	
#4002—Speaker	

PINS

BALLY	
Surf Queens	\$289.50
EXHIBIT	
Big Hit (Single Play)	\$298.50
Big Hit (Multiple Play)	396.50
GOTTLIEB	
Stage Door Canteen	\$249.50
MARVEL	
Catalina	\$249.50
P & S	
Kismet	\$249.50
UNITED	
Riviera	
WILLIAMS	
Suspense	\$279.50

COUNTER GAMES

DAVAL	
Marvel, Plain	\$50.00
With Ball Gum Vender	55.00
Marvel, Non-Coin Operated	54.00
With Ball Gum Vender	59.00
American Eagle, Plain	50.00
With Ball Gum Vender	55.00
American Eagle, Non-Coin Op.. ..	54.00
With Ball Gum Vender	59.00
PIONEER	
Smiley	

ARCADE

AMUSEMATIC CORP.	
Lite League	\$425.00
AMUSEMENT ENTERPRISES CO.	
Bank Ball	\$375.00
BALLY	
Undersea Raider	\$399.50
CHICAGO COIN	
Goalee	\$525.00
EVANS	
Ten Strike	\$372.50
GENCO	
Total Roll	\$525.00
JAFCO	
Roll-A-Ball	\$379.50
MUNVES	
Super Roll	\$349.50

CONSOLES

BAKER	
5c Bakers Pacers Csh Std Mod..	\$500.00
25c Bakers Pacers Csh Std Mod..	550.00
5c Bakers Pacers Csh DD Mod..	550.00
25c Bakers Pacers Csh DD Mod..	600.00
5c Bakers Pacers Chk Sep Std Mod	525.00
5c Bakers Pacers Chk Sep DD Mod	575.00
EVANS	
Bangtails 5c Comb 7-Coin	\$674.50
Bangtails 25c Comb 7-Coin	764.50
KEENEY	
Bonus Superbell	

ONE-BALLS

BALLY	
Victory Derby	\$574.50
Victory Special	589.50

SLOTS

GROETCHEN	
Columbia Twin JP	\$132.50
Lots of 5 or more.....	127.50
O. D. JENNINGS	
5c Bronze and Std Chiefs.....	\$249.00
10c Bronze and Std Chiefs.....	259.00
25c Bronze and Std Chiefs.....	269.00
5c DeLuxe Club Chiefs.....	259.00
10c DeLuxe Club Chiefs.....	269.00
25c DeLuxe Club Chiefs.....	279.00
5c Super DeLuxe Club Chief....	274.00
10c Super DeLuxe Club Chief...	284.00
25c Super DeLuxe Club Chief...	294.00
50c Silver Eagle	
Challenger	475.00
MILLS	
5c Black Cherry Bell.....	\$238.00
10c Black Cherry Bell.....	243.00
25c Black Cherry Bell.....	248.00
50c Black Cherry Bell.....	328.00
New Vest Pocket Bell	74.50

**C.M.I.
BLUE
BOOK**



Actionfrom—Stars
 Ajaxfrom—Score Card
 All Out.....from—Cross Line
 Archeryfrom—Cadillac
 Arizonafrom—Sun Beam
 American Beautyfrom—Attention
 Battlefrom—Zombie
 Big Tent.....from—Big Show
 Big Three
 Big Top of '45.....from—Twin Six, Clover,
 Sky Ray
 Bingofrom—Lite-A-Card
 Bombardierfrom—Follies '40
 Bowling Alley '42.....from—Bowling Alley
 Brazilfrom—D-Re-Mi
 Burleskfrom—Follies '40
 Casablancafrom—Glamour
 Cupidfrom—Roxy
 De-Icer.....from—Red, White & Blue
 Destroyerfrom—Cadillac
 Dive Bomberfrom—Formation
 Eagle Squadron.....from—Big League,
 Big Town
 Easy Pickin'from—O'Boy
 Falling Suns.....from—Ten Spot
 Fan Dancerfrom—Roxy
 Flashfrom—Punch
 Flat Top.....from—Broadcast, Crossline
 Flightfrom—Sporty
 Flying Tigers.....from—Play Ball
 Foreign Colorsfrom—Owl
 Grand Canyon.....from—Double Play
 Hi-Boyfrom—Metro
 Hi-Jinksfrom—Glamour
 Hit-The-Japsfrom—Gold Star
 Hockey '42.....from—Silker Skates
 Idahofrom—Zombie
 Jeep....from—Duplex, Leader, Sky Blazer
 Kismet
 Klipperfrom—Scoop
 Knock-Out-The-Japsfrom—Knockout

Libertyfrom—Flicker
 Luxuryfrom—Rotation
 Marines-At-Playfrom—Flicker
 Midwayfrom—Zombie
 Nite Clubfrom—Formation
 Nine Bells.....from—Mr. Chips
 Over-The-Topfrom—Powerhouse
 Parade Leader.....from—Drum Major
 Paratroopfrom—Powerhouse
 Peacherinofrom—Jolly
 Pepfrom—Wow
 Playtimefrom—Gold Star
 Pin Up Girl.....from—Silver Skates
 Productionfrom—Blondie
 Ratfrom—Zig Zag
 Redheadsfrom—Blondie
 Roll Callfrom—Vacation
 Sailorettes '42.....from—Follies '40
 Scout Commanderfrom—Fleet
 Sea Power.....from—Four Roses
 Sentryfrom—Leader
 Shangri-Lafrom—Mr. Chips
 Sink-The-Japfrom—Seven Up
 Sixty Grand.....from—Big Town
 Sky Rider.....from—Pan American
 Slap-The-Japfrom—Stratoliner
 Smak-The-Japfrom—Ten Spot
 South Seasfrom—Knockout
 Speedwayfrom—Entry
 Spot-Chafrom—Attention
 Stage Door Canteen.....from—Liberty
 Starlightfrom—Triumph
 Stepperfrom—Blondie
 Strip Tease.....from—Chi-Coin Games
 Torpedofrom—Formation
 Trade Winds.....from—Sky Blazer
 Triple Entry.....from—Home Run
 Wagon Wheelsfrom—Duplex
 White Sails.....from—Silver Spray
 Yankee Doodle
 Zingofrom—Mascot, Attention,
 Silver Skates, Air Force

REVAMPED ONE-BALLS

All-American Derby..from—Sport Special,
 Record Time
 Big Three
 Dust Whirls.....from—Club Trophy
 Fast Track from—Sport Page, Blue Ribbon
 Foreign Colorsfrom—Owl
 Pastimefrom—Turf Champs

Race King..from—Thistledown, Sea Biscuit
 Rockingham...from—Grand Stand, Grand
 National, Pacemaker
 Victoriousfrom—Turf Champs
 War Admiral.....from—Grand Stand
 Whirlaway..from—Blue Grass, Dark Horse,
 Sport Specia)

\$ \$ \$ \$ \$ \$ \$ \$ \$ \$ \$ \$ \$ \$ \$

SENSATIONAL MONEY MAKER

For
Arcades — Carnivals — Shooting Galleries

THE NEW

ELECTRIC MACHINE GUN

WITH COMPLETE MOVING TARGET

IS NOW HERE — AND SELLING FAST

\$3250⁰⁰ F.O.B. N.Y.C. INCLUDING COMPLETE 12 FT. TARGET AND 4 ELECTRIC MACHINE GUNS

LIMITED QUANTITY!! WRITE IMMEDIATELY!!

RUNYON SALES CO. of NEW YORK, Inc.

593 TENTH AVENUE (PHONE: LONGACRE 3-4820) NEW YORK, N. Y.

\$ \$ \$ \$ \$ \$ \$ \$ \$ \$ \$ \$ \$ \$ \$

THANKS A MILLION

**FOR THE GREATEST ATTENDANCE
IN THE HISTORY OF THE EAST'S
AUTOMATIC MUSIC INDUSTRY**

EVERY OPERATOR SAID:

"NOW I'VE SEEN THE BEST!"



RUNYON SALES COMPANY

EXCLUSIVE AMI DISTRIBUTORS

FOR NEW YORK — NEW JERSEY — CONNECTICUT

**SELL US YOUR MUSIC MACHINES OR
YOUR A. M. I. TELEPHONE
STUDIOS AND EQUIPMENT**

TAKE ADVANTAGE OF TODAY'S PRICES!

**Want Any Quantity — On Or Off Location Or Complete Routes — Anywhere In U.S.A.
WILL PAY HIGHEST CASH PRICES! PHONE — WIRE — WRITE**

MUSIC MACHINES READY FOR LOCATION

5 Wurlitzer 412.....\$179.00	2 Wurlitzer 500..... 495.00	3 Seeburg HiTone ES..... 625.00
5 Wurlitzer 616..... 269.00	1 Wurlitzer 24 Victory '42 435.00	5 Seeburg HiTone RCES..... 675.00
3 Wurlitzer 24..... 335.00	1 Seeburg B200 RCES..... 745.00	2 Rock-Ola 12 Record..... 145.00

We can deliver all makes and models of phonographs. Write or phone your needs!

SPECIAL THIS WEEK

5 AMI HIGHBOYS 40 RECORDS, FACTORY CRATED.....	\$549.50
25 NEW 20 RECORD AMI BAR BOXES.....	23.00

MISCELLANEOUS

15 Wurlitzer #120 Boxes, 5c.....	\$24.50	2 Seeburg 5/10/25c Bar-O-Matic Wireless.....	49.50
10 Wurlitzer #125, 5/10/25c.....	22.50	50 Buckley Boxes 24 Record, lift door.....	9.50
10 Wurlitzer #145 Fast Stepper.....	40.00	25 Buckley Bar Brackets.....	.95
10 Wurlitzer #304 Stepper.....	19.50	50 Buckley Pedestals.....	2.50
5 Rock-Ola Well Boxes.....	12.50	5 Wurlitzer 412 Amplifiers, less tubes.....	25.00
4 Seeburg 20 sel. wireless 5c.....	39.50	10 Keeney Speaker Baffles.....	17.50
10 Seeburg 24 Boxes — 3-wire, 5c.....	22.50	10 Adapters for Mills Empress.....	32.50
		5 Chendeller Speaker Baffles, Lite Up.....	15.00

WANT 616 MECHANISMS COMPLETE IN STEEL CABINETS, OR SINGLE. WE PAY HIGHEST PRICES. WRITE IMMEDIATELY.

TERMS: 1/2 Certified Deposit Must Accompany All Orders. We Ship Balance C.O.D., F.O.B. Newark, N. J.

**5 AMI
TELEPHONE
STUDIOS**

COMPLETE — SLIGHTLY
USED. WRITE — WIRE —
OR PHONE FOR DETAILS.

Built Specially for U.S. Govt.
UNIVERSAL AMPLIFIERS
For all Wurlitzer, Rock-Ola,
Seeburg Machines.
Tone Quality and plenty of
volume with switches, volume
control, and tone control.
Order Immediately! Price.....
We take old amplifiers in trade-ins.

\$47⁵⁰

NEW WURLITZER RECORD TRAYS
FOR ALL MODELS EXCEPT COUNTER MODELS
IN LOTS OF 100
OR MORE EA. **42c**

RUNYON SALES COMPANY

123 WEST RUNYON STREET, NEWARK 8, NEW JERSEY

(ALL PHONES: BIGELOW 3-8777)

THE NEW ELECTRIC MACHINE GUN

IS NOW HERE - AND LEAVING ALL

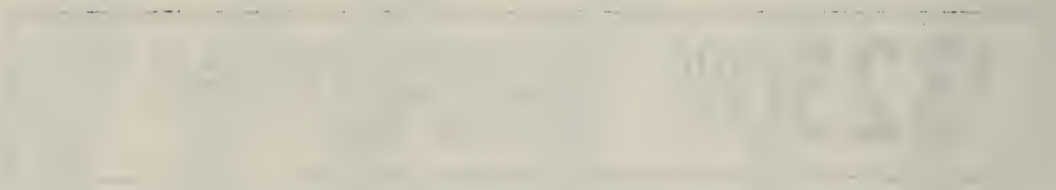

RUNNING SALES CO. OF NEW YORK, INC.

SELL US YOUR MUSIC MACHINES OR
YOUR A.M.I. TELEPHONE
STUDIOS AND EQUIPMENT
TAKING ADVANTAGE OF TODAY'S MARKET
YOU WILL PAY MORE FOR YOUR INSTRUMENTS



1900
1910

1910

WANT

WANT

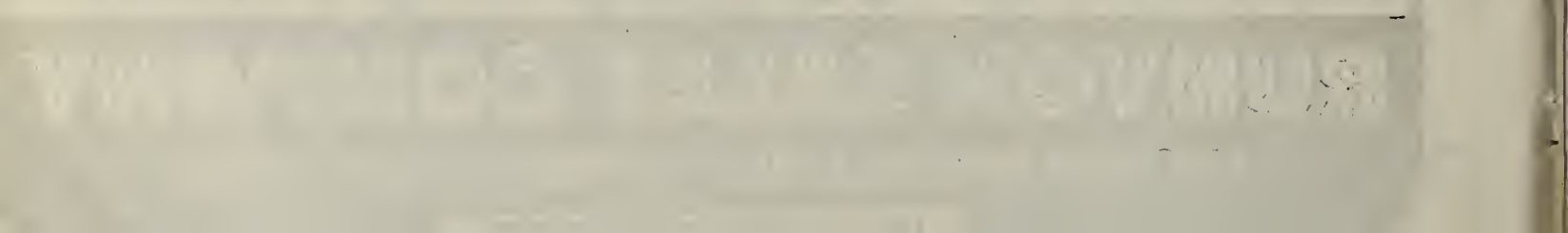

ROCK-OLA

The
**PHONOGRAPH
OF TOMORROW.....**

Today



Automatic Phonograph

Owners Everywhere say:

"Just what we've been waiting for!"

ROCK-OLA MANUFACTURING CORPORATION

800 N. KEDZIE AVE. ★ CHICAGO 51, ILL.

W. H. W. W.

W. H. W. W.

W. H. W. W.

W. H. W. W.



* Measured Music *

The Personalized Music System



Your "TAKE" is not limited to one nickel at a time when it's a *MEASURED MUSIC* stop.

That's why smart operators are all going the *MEASURED MUSIC* way.

Get your locations converted now and cash in on this Multiple-Profit deal.

SHIPMENTS ARE NOW BEING MADE

'Phone or Write

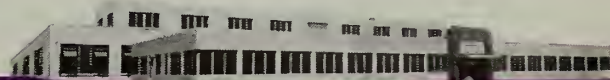

THE HOME OF *MEASURED MUSIC*

PERSONAL MUSIC CORPORATION

PHONE: BIGELOW 8-2200 . . . P. O. BOX 720 . . . U. S. HIGHWAY NO. 1 . . . NEWARK N. J.

*Reg. Trade Mark

BOSTON MUSIC OPS WILL FORM ASSN.

MEETING HELD MARCH 21 SET GROUNDWORK, ORGANIZATION MEETING CALLED FOR APRIL 3; 70%-30% COMMISSION BASIS HAILED. SUNDAY LICENSE TAX, LOCATION PIRATING FLAYED

BOSTON — Music operators in this city have joined others thruout the nation in calling for adoption of *The Cash Box* plan that a 70-30 percentage commission rate be established here.

Rallying to a special meeting called last week by Al Dolins, Pioneer Music Company head, the operators came to agreement that this adjustment must be made.

The results of the meeting, reported exclusively to *The Cash Box*, struck the first heavy notes in a program that may well knit music operators in this city into one of the most progressive groups in the nation.

Spearheading the drive to inaugurate the 70-30 commission basis is the plan to bring all operators in this area into an organized association. The groundwork and the initial plans of the association was laid at the meeting held on March 21, at the New Copley Square Hotel here.

"An association of operators in this territory is vitally necessary," said Al Dolins, who served as chairman. "If we're ever to realize the 70-30 commission rate we've got to have 'togetherness' among ourselves. Every music operator in the business is well aware of today's overhead costs, and just as he's aware of that, he's aware of what a difference the 70-30 commission rate would mean to him.

"We're going ahead to gain for ourselves the benefits to which every operator has so long been entitled, and the time is now."

Pirating of locations by individual operators and the Sunday license tax also came up for discussion during the meeting, and plans were drawn up to combat these conditions.

"For a long time there has prevailed in this area a a number of wrongs long in need of correction," Dolins reported. "Our businesses have suffered as a result of the loose

relations among operators here. This is a turning point in the history of the industry, and this is the time to get things done. We are urgently requesting that all operators in this area join us in our efforts, attend our meetings, and give their ideas on matters under discussion. All of our meetings planned for the future will be of great importance to every operator. This is a beginning and we want to begin together."

The next meeting of the group will be held on April 3rd, at the New Copley Square Hotel, this city.

Nickel In Slot Sets Fire Bells Ringing

OKLAHOMA CITY, OKLA. — The woman stopped and walked over to an automatic news vendor to purchase a paper. She paused before the machine, seeking a place to pay.

Finally she pushed her nickel into a little red box on the corner pole, then pulled the handle on the box.

Three engine companies, two trucks, a squad car and the fire chief answered the alarm.

NOW DELIVERING

LITE LEAGUE NO GAME EVER BUILT LIKE IT \$425.00, IMMEDIATE DELIVERY
New Hollywood - 5-Ball Game.....\$249.50

USED MACHINES

- Mills Punching Bag, refinished like new.....\$145.00
- Chicken Sams Converted to Rifle Range, Overhauled and Refinished like new..... 149.50
- Chicken Sam A-1 94.50
- Bally King Pin 225.00
- 9 Ft. Bowl-A-Bomb..... 129.50
- 9 Ft. Bowling League 129.50
- American Eagles (Non-Coin Metered)..... 24.50
- Turf Flash (Counter Game, like new)..... 24.50
- Sup. Skee Roll 225.00
- 7'-6" Roll-A-Ball 200.00

WANT—5-Ball Games, Ten Strikes, Western DeLuxe Baseballs.

WISCONSIN NOVELTY CO.
3734 N. GREEN BAY AVENUE
MILWAUKEE, WIS.

NEW WINNERS

ALL A-1 RECONDITIONED ARCADE EQUIPMENT

UNDER SEA RAIDER.....\$399.50	GOALEE.....\$525.00	SKEE BARREL ROLL.....\$369.50
A.B.T. Challengers..... 25.00	A.B.T. Target Skill (Late Model)..... 22.50	A.B.T. Target Skill (Model-F)..... 17.50
Ace Bomber..... 219.50	Aero Ball..... 39.50	Bally Alley..... 29.50
Bally Basket Ball (Repainted)..... 75.00	Bally Bull..... 69.50	Bally Rapid Fire..... 119.50
Barrel O' Fun (Exhibit)..... 99.50	Battling Practice (Scientific)..... 109.50	Bicycle Speed Tester (Exhibit)..... 125.00
Card Vendors (Exhibit) with Base..... 25.00	Card Vendors (Metal Int.) 2 for 5c..... 39.50	Chicago Coin Hockey..... 189.50
Chuck-O-Luck..... 5.00	Circus Romance..... 249.50	Casino Golf (new)..... 49.50
Casino Golf (used)..... 29.50	Donkey Strength Tester..... 139.50	Egyptian Mummy Exhibit..... 119.50
Evans 36 ft. Duck Pin Alley, Automatic..... 189.50	Pin Set-Coin Operated (Uncrated)..... 99.50	Evans Tommy Gun..... 100.00
Fireman (Int. Thigh-O-Graph)..... 29.50	Golf Put-er-in 6 ft. Gripper, Single (Gottlieb)..... 15.00	Grip Tease..... 59.50
Hockey (Seeburg)..... 69.50	Int. Mutoscope (with stand)..... 29.50	Int. Mutoscope L. Sign Counter..... 25.00
Jungle Hunt..... 129.50	Keeney Air Raider..... 42.50	Keeney Anti-Aircraft..... 89.50
Keeney Submarine..... 89.50	Keeney Targarette..... 22.50	Kicker & Catcher..... 169.50
Kiss-O-Meter..... 69.50	Knotty Peak (without stand)..... 215.00	Liberator..... 189.50
Lift-O-Grif..... 189.50	Lion-Head (Electric Shocker at 1c)	(Large Wall Machine).....\$ 49.50
	Love Meter..... 29.50	Love-O-Meter..... 129.00
	Mills Panoram..... 295.00	Mystic Eye (Exhibit)..... 139.50
	Pike's Peak..... 15.00	Pike's Peak Stands..... 1.95
	Peep Show (Back to Nature)..... 49.50	Peep Show (Have a Look)..... 49.50
	Planetellus (without side signs)..... 39.50	Periscope..... 215.00
	Poker and Joker..... 89.50	Radiogram (Exhibit)..... 150.00
	Rameses (Exhibit)..... 129.50	Red, White and Blue Target (A.B.T.)..... 22.50
	Rockola Ten Pins..... 69.50	Screen Test..... 149.50
	Seeburg Chicken Sam..... 109.50	Seeburg Gen. (Bartender) (Repainted)..... 169.50
	Seeburg Gun (Photo Elec. Rifle Range) (Repainted)..... 169.50	Skee Balette (Gottlieb)..... 69.50
	Skee Jump (Repainted)..... 59.50	Shocker Advance Electric 1c..... 12.50
	Sky Fighter..... 219.50	Striking Clock (counter model)..... 49.50
	Super Bomber (Evans)..... 235.00	Stoner's Races..... 89.50
	Tail Gunner..... 99.50	Ten Strike Evans..... 69.50
	Test Pilot (Cabinets Only)..... 20.00	Texas Leaguer..... 42.50
	Thunderboit (like new)..... 175.00	Tokyo Gun..... 99.50
	Tricks (Genco) Pin Ball..... 29.50	United Nations..... 89.50
	Western Strength Test..... 39.50	Whoopee Ball..... 3.50
	World Series (Rockola)..... 89.50	Your Future Home..... 29.50
	Zingo..... 119.50	

IDEAL NOVELTY COMPANY
2823 LOCUST ST. (Phone: FRanklin 5544) ST. LOUIS, MO.

C O L U M B I A B E L L S

NEW — IMPROVED — 1946 MODELS
IMMEDIATE DELIVERY

Fresh off the production lines — featuring an array of new mechanical improvements — comes the famous COLUMBIA TWIN JACKPOT BELL!

These new, improved 1946 models in dazzling, durable Hammerloid finish are changeable right on location to 1-5-10-25c play hence, you get the service of four machines for the price of one . . . plus double slug protection!

COLUMBIA makes more money f-a-s-t-e-r — costs less money to own.

OPERATOR'S PRICE

\$127⁵⁰

IN LOTS OF 5

\$132⁵⁰

SINGLE

All orders must be accompanied by a one-third deposit, postal money order or certified check, balance C.O.D., F.O.B., Chicago.

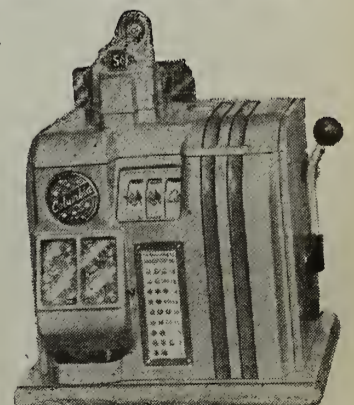

ABCO NOVELTY CO.

809 W. MADISON, CHICAGO 7, ILL.
(Phone: HAYMARKET 3695)

808704 1011 1942
WILL FROM 1942
MAY 1942
1942

COLUMBIA BELL
1942
1942
1942

RIVIERA

CONVERTED FROM
"BIG PARADE"

We Are Also Converting

- | | |
|-------------|----------|
| ZOMBIE | DO-RE-MI |
| SUN BEAM | STARS |
| DOUBLE PLAY | LEADER |
| WEST WIND | DUPLEX |
| SKY BLAZER | KNOCKOUT |

NOTE

We will buy at \$60.00 each, f.o.b., our factory, any of the above listed games.

See Your Distributor or Write Direct!

UNITED MANUFACTURING COMPANY 6125 N. WESTERN AVE. CHICAGO 45, ILLINOIS

KENTUCKY TOWN TO SLAM HIGH TAX ON JUKES & PINS

EARLINGTON, KY. — An annual bite of \$50 per juke box and \$25 per pin game will be forced on operators here if an ordinance suggested and unanimously approved by councilmen as desirable is passed by the City Council at its next session.

The tax, in the form of a license fee, is extremely high in the light of present conditions, but no reaction has been reported at the time the tax proposal was made public.

At the present time, the ordinance is in the hands of the city attorney who will prepare the proposed ordinance for presentation and passage at the next regular meeting of the city council. It was sent to the city attorney after the councilmen had given their verbal approval of the measure and had routed it to the city clerk for preparation and presentation by the city attorney.

The City Fathers are hinging their claim on the righteousness of the tax by claiming that the major portion of the take earned by the machines is going to operators who are non-residents of this city, though resident location owners are gaining a profit from the equipment.

The City Fathers have further expressed the opinion that the city should receive some revenue from these operations and therefore decided on the proposed ordinance, which undoubtedly will be passed at the next session of the council.

ONE OF THE MOST PROFITABLE OPERATORS' MACHINES EVER BUILT

PHOTOMATIC

(Trade Mark)

SEND FOR THE SPECIAL PHOTOMATIC SELLING PLAN

INTERNATIONAL MUTOSCOPE CORP.

44-01 ELEVENTH ST.

(WM. RABKIN, President)

LONG ISLAND CITY 1, N. Y.

1946 — Our 51st Year of Service



NEW YORK — Danny O'Neil, singing star and artist for Majestic Records, was an enthusiastic listener to Aireon's Electronic Phonograph as they were first shown in this city at

the showrooms of the Manhattan Phonograph Company.

O'Neil appears over WABC Thursday evenings in the "Powder Box Review."

Exotic! RIGHT OUT OF FAIRYLAND
LIKE A MAKE-BELIEVE BUBBLE-BATH
IN ENCHANTED PINK CHAMPAGNE!



**PACKARD
PLA-MOR No. 1000**

Out of this World

SHIMMERING ★ SPARKLING ★ SCINTILLATING ★ SPECTACULAR

For sheer, sparkling, scintillating, effervescent beauty, nothing can approach the 1000—Packard's proudest speaker presentation. For tone—liquid melody floating in the air—no ceiling speaker can touch it. It's more than beautiful. It's truly "out-of-this-world"—like a bit of enchanted fairyland—like a make-believe bubble-bath in pink champagne.

Ink and paper can't tell you about it. You have to *experience* it. And seeing it *is* an experience. It really does fill the room with bubbles—bubbles of reflected colorful light—dancing on the walls, on the pillars, on the tables—on the patrons. This is for your deluxe locations—and the ones that want to be—the dream-boats and wonderbars. Unmatched! Unparalleled!

IT ROTATES — OPERATES WITH ANY PHONOGRAPH — IT'S TERRIFIC

THE PLA-MOR DAHLIA — 700

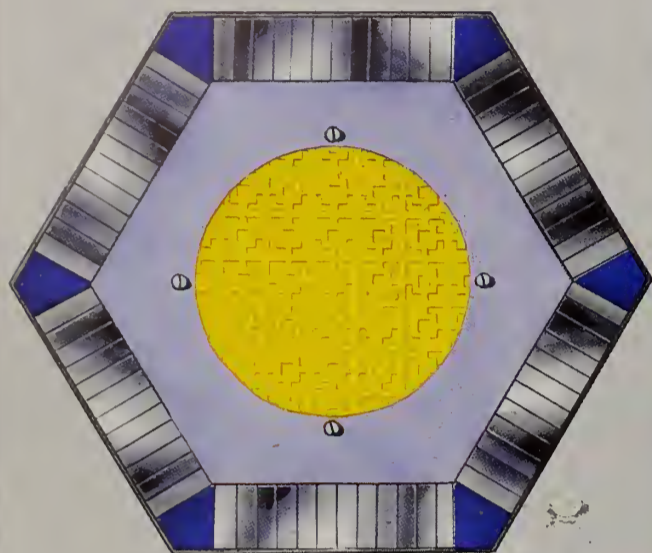

THE PLA-MOR DAISY — 800

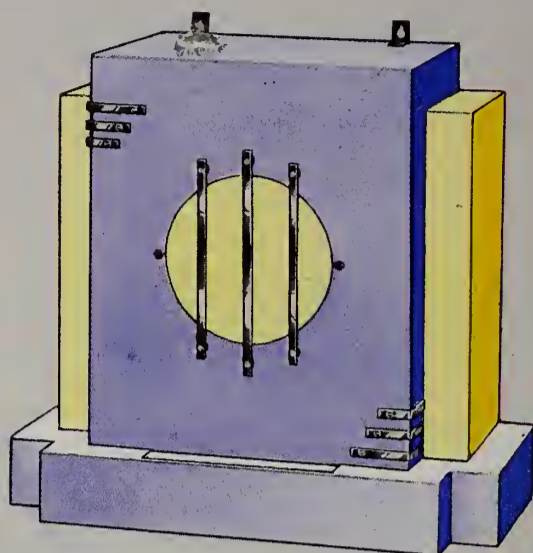

THE PLA-MOR ROSE — 900

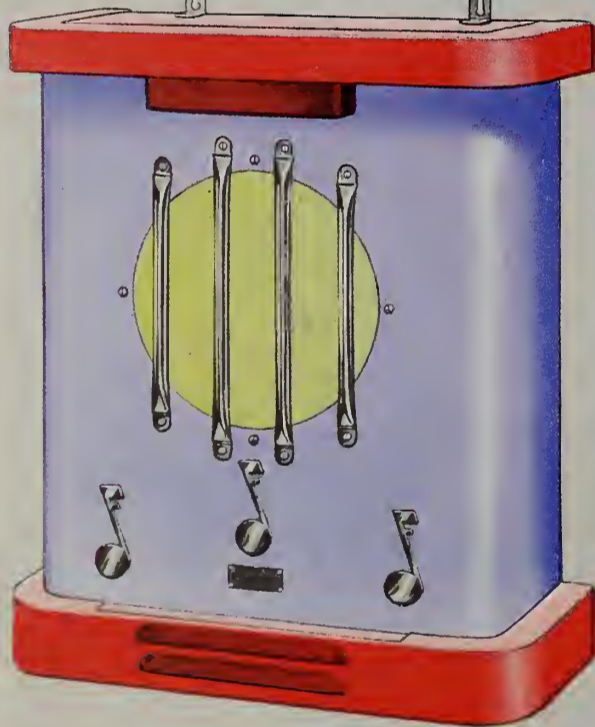

Sell YOUR MUSIC!
DON'T JUST *Offer* IT!

● These auxiliary wall speakers—plus No. 1000 on the preceding page—complete a line unmatched in excellence—and in irresistible music salesmanship.

Shown here—in natural color—are the Dahlia (16-inch hexagon—8-inch p-m speaker); the Daisy (20 by 21 inches—8-inch p-m speaker—indirectly lighted) and the Rose (24 by 28 inches—12-inch p-m speaker—indirectly lighted top and bottom). They're beautiful. They're decorative.

In tone, there's nothing better. It's the band in person. Packard adds nothing—takes away nothing. It's the true voice of the instruments—just as recorded—just as the listener wants it. Such reproduction means each beautiful melody calls for another. Packard sells your music—doesn't just *deliver* it!

Pla-Mor Speakers operate with any phonograph—floor or hideaway. Add Pla-Mor Selective Remote Control Wall Boxes and you have the Packard Pla-Mor Music System—tops in quality—fairest in cost—surest in bringing extra profit.

PACKARD
(PLA-MOR)
MUSIC SYSTEM

PACKARD MANUFACTURING CORP.

HOMER E. CAPEHART, Chairman of the Board

WANT TO BUY AT ONCE!

MILLS 3 BELLS

PHONOGRAPHS

MILLS ESCALATOR SLOTS

FREE PLAY CONSOLES

SALE!!

SALE!!

READY FOR IMMEDIATE DELIVERY . . . THOROUGHLY RECONDITIONED

ARCADE

1 World Series	\$100.00
3 Anti-Aircraft	85.00
3 Tail Gunners	95.00
3 Evans Tommy Guns	149.50
3 Sky Fighters	275.00
4 Rapid Fire	175.00
1 Submarine	165.00
1 Western Baseball—1939	125.00

2 Skee-Ball-Ette	60.00
1 Batting Practice	149.50
1 Talkie Horoscope	125.00
1 Muscle Builder	\$ 99.50
2 Bally Alley	75.00
2 Pace Bowling Alley	375.00
1 Coast Leaguer	139.50

1 1942 Playball	139.50
4 Bang A Deer	75.00
1 Love Tester	29.50
1 Zingo	95.00
1 Rockola Ten Pin	69.50
1 Periscope	127.50
2 Rotary Merchandisers	295.00

CONSOLES

1 Rio	\$ 25.00
2 Square Bells	85.00
1 Galloping Dominos	295.00
1 Royal Flush	69.50
2 Spinning Reels	110.00
2 Paces Races	174.50
2 Saratoga	174.50

1 Maybell	325.00
1 Skill Time	85.00
4 Jumbo Parade (Auto.)	150.00
4 Jumbo Parade (Comb.)	\$205.00
4 Paces Reels	149.50
3 Liberty Bell	24.50
1 Multiple Racer	95.00

1 Super Bell 3/5 1/25	595.00
2 Derby Day	49.50
1 Skill Field	89.50
1 Saddle Club	47.50
1 Sugar King	50.00
1 Royal Lucre	290.00

PIN BALL

1 Broadcast	\$ 69.50
1 Triumph	35.00
1 Strat-O-Liner	60.00
3 Dude Ranch	54.50
1 Attention	69.50
2 Big Chief	65.00
2 Limelight	35.00
10 Vogue	27.50
1 Jolley	29.50

1 Top Notcher	24.50
1 Speedway	24.50
1 Champion	39.50
1 Bright Spot	59.50
1 New Champ	\$ 79.50
1 Polo	22.50
1 Silver Skates	59.50
1 Double Feature	25.00
1 Big Parade	125.00

1 Star Attraction	75.00
1 Gold Star	57.50
1 Speed Demon	25.00
2 Mascot	34.50
1 Wow	34.50
1 Gun Club	79.50
1 Crystal	45.00
1 Air Circus	39.50

NEW MACHINES—F.O.B. FACTORY

Chicoin Goalee	\$525.00
Pre-Flight Trainer	850.00
Shipman Stamp Vendor	39.50
Undersea Raider	399.50
Victory Derby	\$574.50

Vest Pocket Bells	74.50
Mutoscope Voice-O-Graph	153.00
Change Makers	9.85
Mutoscope Voice-O-Graph	1153.00

BLACK CHERRY BELLS

Exclusive Distributors
MILLS NOVELTY CO.

INTERNATIONAL MUTOSCOPE CORP.

MILLS INDUSTRIES, INC.

MILLS SALES COMPANY, LTD.

1640 - 18th STREET OAKLAND, CALIF. 1325 S.W. WASHINGTON PORTLAND, OREGON

PUBLIC RELATIONS EXPERT TELLS OPS HOW

NEW YORK — Win Nathanson, President of Tom Fizdale, Inc., Public Relations Counsellors, this city, in the March-April (1946) issue of the "Rowe-Gram", house organ of Rowe Mfg. Co., this city, tells "What Good Public Relations Means To The Operator".

This is one of the most informative articles regarding what operators can do to help gain better understanding in their communities which has ever yet been written. The fact that it is written by Win Nathanson, well known for his expert public relations work, makes it all the more interesting to the trade.

In outlining 8 points for the operators, Nathanson writes:

"1. To the general public (the consumer)—That your machine is reliable in operation, attractive in appearance, returns coins without trouble when necessary, and provides clean and fresh merchandise continuously. In the last analysis, the satisfied customer is your best advertisement. In this case the machine itself is your public relations agent and reflects your business methods.

"2. To the location owner—That he needs your method of merchandising to save him money and time and increase his sales. You convince him of this over a period of time by the smooth operation of your machine and your prompt attention to servicing and repairs. It is important, even when you have employees making the contacts for you, to develop the



WIN NATHANSON

location owner's personal friendship and confidence.

"3. To competitors—That you are a fair and square business man, ready to meet with them at all times to discuss mutual problems. You impress a competitor not only by your business dealings but by joining with him in association and other activities of benefit to the industry as a whole.

"4. To your employees—That they are both your personal representatives and ambassadors of good will for the entire industry and their appearance and conduct must conform; that you are a fair employer who has their personal interests at heart; and that you are typical of the general high calibre of vending machine operators. If your business is too small

to publish a house organ, or even a mimeographed leaflet, you can schedule regular conferences with your employees to check with them on how they are carrying out the public relations objectives.

"5. To the producer and supplier of merchandise—That you offer an expanded market for his goods; that you provide a modern and efficient means of distribution. Get to know your suppliers personally, if possible. Win their respect for yourself and your business.

"6. To the community—That you are an honest business man with a legitimate and useful place in the economy of the community. To help accomplish this, it is necessary to be something of a "joiner." Join your local Chamber of Commerce, and take part in civic and welfare programs. That way you will get to know men in other fields of endeavor who will support you when they know and understand your business.

"7. To the government—That you are entitled to equitable treatment and should be considered in the same category as other sellers of the same kind of merchandise; that you earn your income through the sale of merchandise, not through the machine itself. Education of lawmakers and public officials and the correction of misunderstanding about the industry are the ways to avoid unfair legislation. Try to make the personal acquaintance of your city councilman, county official, state legislator, and Congressman.

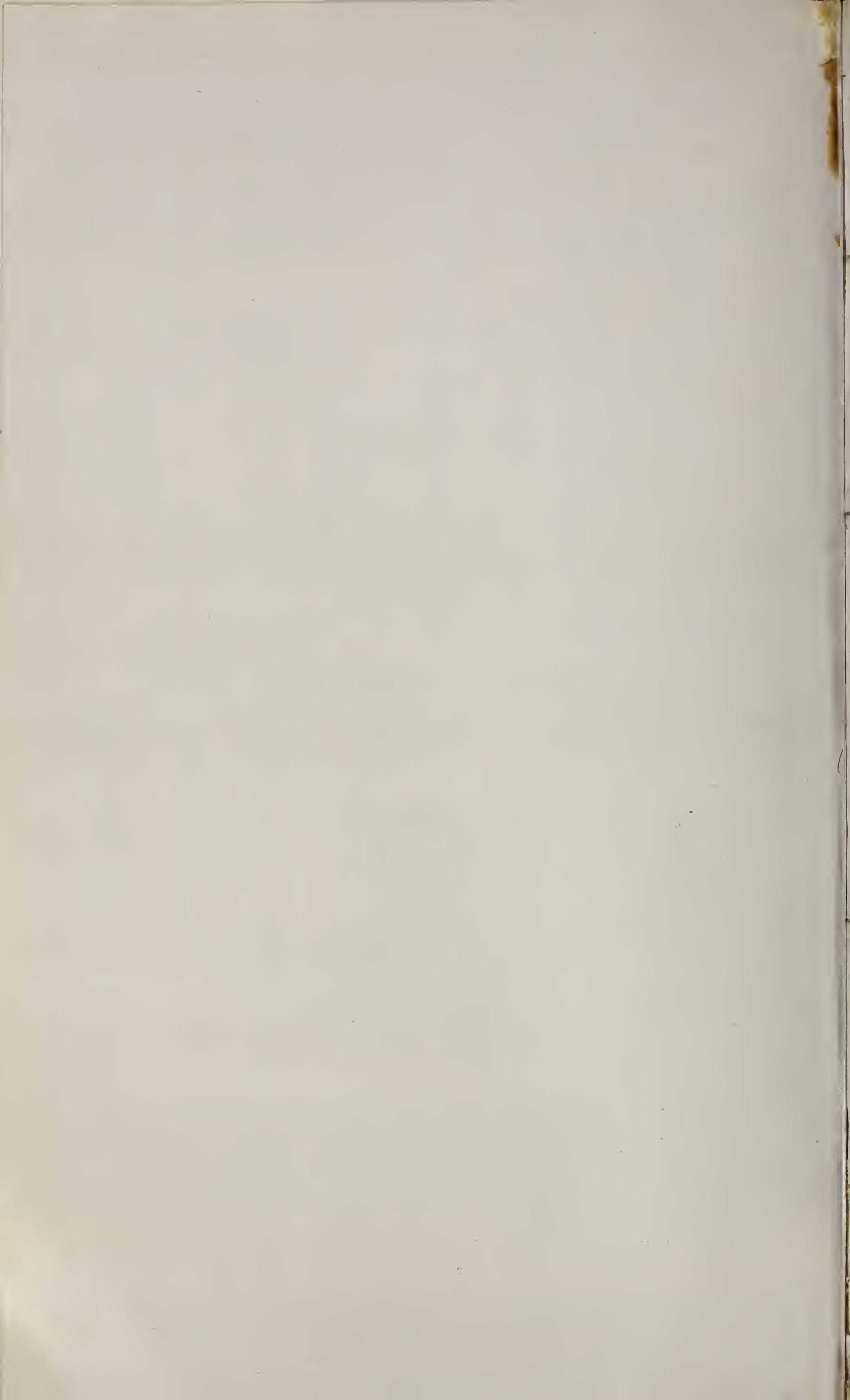

Bill Wolf announces

GRAND OPENING

Our New Seattle Headquarters

APRIL 10th and 11th, 1946

2313 Third Avenue

Seattle, Washington



PREMIERE SHOWING

of

THE NEW

AMI

PHONOGRAPH

APRIL 10th and 11th, 1946

at our

Seattle Headquarters

2313 Third Avenue

Seattle, Washington



M. S. WOLF DISTRIBUTING CO.

(FORMERLY: CALIFORNIA AMUSEMENT CO.)

Bill Wolf, Publisher

3 B A N D 3 O P E N I N G

On New Street in Washington

April 10th and 11th, 1944

313 Third Avenue Seattle, Washington

3 B A N D 3 O P E N I N G

THE NEW

A M I

3 B A N D 3 O P E N I N G

April 10th and 11th, 1944

at

Seattle Hotel

313 Third Avenue Seattle, Washington

2

M. S. WOLF DISTRIBUTING CO.

JOIN CMI IS W. F. STRUBY'S MEMO TO NATION'S OPS

A Special Message

By W. F. STRUBY

President, Packard Manufacturing Corp.
Indianapolis, Ind.

It is my personal opinion that every operator of any kind of coin operated machine should become an Associate Member of Coin Machine Industries, Inc., in support of their Public Relations Program.

CMI has undertaken a tremendous task in attempting to sway public good will toward coin operated machines whether they are music, vending, amusement or weighing.

The committee in charge of this program considered the plans very carefully before launching their campaign for membership of operators and distributors. I am sure their decision was right to solicit their support first because, without any investment in a project, the extent of the individual cooperation that may be obtained in the success of the project is doubtful.

The manufacturers in the coin machine industry are determined this Public Relations Program must be carried out as planned and will contribute whatever may be necessary to insure its success.

For operators and distributors it is an investment in insurance to perpetuate the industry that provides their living along with a bit of cake. With public opinion on the side of the coin machine industry there is bound to be less regulation, taxation and legislation to harrass the industry.

If you have not sent in your application and check in support of CMI's Public Relations Program I suggest you do it now. If you do not have an application handy just send in your check for \$25.00 payable to Coin Machine Industries, Inc., and attach it to your letterhead or business card and address to Room 508, 134 N. La Salle St., Chicago 2, Illinois.

IDEAL NOVELTY CO.

2823 LOCUST ST., ST. LOUIS, MO.

Is Proud To Announce The Following Exclusive Distributorships:

ROCK-OLA MANUFACTURING CO.

Missouri and Southern Illinois
Rock-Ola Phonographs

MARVEL MANUFACTURING CO.

Missouri and Southern Illinois

Hollywood Catalina

PIONEER COIN MACHINE CO.

Missouri, Illinois, Arkansas, Kansas,
Eastern Kentucky

Smiley Legal Counter Game

Big Top 5-ball Free Play Game

NORTHWESTERN CORPORATION

Missouri and Southern Illinois
Deluxe Vending Machine Line

CREATORS MANUFACTURING CO.

Missouri, Southern Illinois, aKnsas
Complete Line of Popcorn Poppers

UNITED MANUFACTURING CO.

Missouri and Southern Illinois
5-Ball Free Play Games

INTERNATIONAL-MUTOSCOPE CORP.

Missouri, Kansas

Photomatic — Complete Arcade Line
Voice-O-Graph

BALLY MANUFACTURING CO.

Missouri and Southern Illinois
Victory Derby — Surf Queen
Under Sea Raider — Victory Special

CONTAINER MANUFACTURING CORP.

Missouri and Illinois

Complete Line of New Punch Boards

SHIPMAN MANUFACTURING CO.

Missouri and Southern Illinois
Postage Stamp Vending Machines

AMERICAN AMUSEMENT CO.

Missouri, Illinois, Arkansas, Kansas,
Eastern Kentucky
Rebuilt Slots

SAVE YOUR RECORDS

CRYSTAL CONVERSION
KITS FOR YOUR
MUSIC BOXES

Reduces record wear by 50%, improves tone of machine, saves your needles, reduces service due to bad records. Complete instructions with each crystal.

KIT #1

For Seeburg Round Head Tone Arms

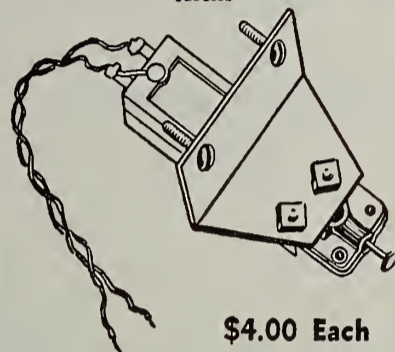

\$4.00 Each

KIT #2

For Seeburg Flat Head Tone Arms

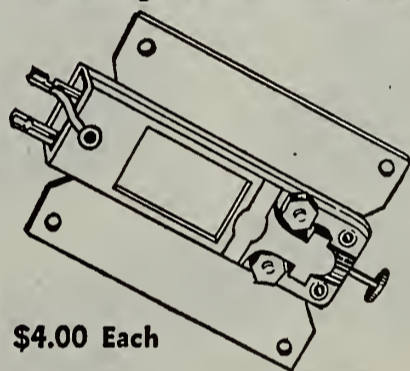

\$4.00 Each

"B" Style Cartridge for MILLS
and ROCK-OLA

\$3.00 Each

M-22 Style Cartridge for Singing
Towers

\$3.00 Each

ALL ABOVE CRYSTALS ARE
MADE BY

ASTATIC

Known the World Over for Their
Dependability

KEYS LOST?

DON'T LOSE THEM AGAIN

25c EACH

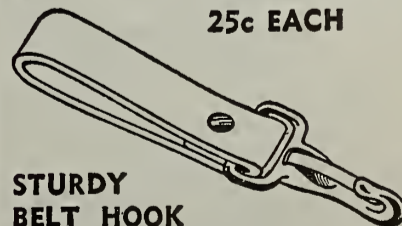

STURDY
BELT HOOK

1/3 CASH WITH ORDER, BALANCE
C. O. D.

JEWEL COIN MACHINE PRODUCTS

227 Chicago Pl., N. W.
Canton 3, Ohio

2700 2-11-78 11 3/30

3742

11/11/78

[Faint handwritten notes and markings on the left side of the page]

[Faint printed text at the bottom of the page, possibly a form or header]



"QUICK

TO

CLICK"

TRADE MARK
FOR
AMUSEMENT ENTERPRISES CO.
GAMES

14 Ft. Size
Pictured Here

AMUSEMENT ENTERPRISES CO.
GEORGE PONSER • IRVING KAYE
2 COLUMBUS CIRCLE NEW YORK 19, N. Y. CIRCLE 6-6651

NOW DELIVERING
BANK BALL

The first in a series of games that
will be "Quick to Click" for you.

9 FOOT SIZE
F.O.B., N.Y. **\$375⁰⁰**

12 and 14 FT. SIZES
Prices on Request

— Order From Your Nearest Distributor —

Distributed in Ohio, Michigan, West Virginia
and Kentucky by

**NICKEL AMUSEMENT
COMPANY**

1648 St. Clair Avenue
Cleveland 14, Ohio

Distributed in
Texas and New Mexico by
WALBOX SALES CO.

1503 Young Street Dallas, Texas

Distributed in Eastern Pennsylvania
and Southern New Jersey by

DAVID ROSEN

855 N. Broad St. Philadelphia 23, Pa.

Distributed in
Western Pennsylvania by

**AMERICAN COIN-A-MATIC
MACHINES CO.**

1437 Fifth Avenue Pittsburgh 19, Pa.

Distributed in
Northern New Jersey by

**HERCULES SALES
& DISTRIBUTING CO.**

415 Frelinghuysen Avenue
Newark 5, N. J.

Distributed in
District of Columbia, Maryland,
No. Virginia and Delaware by

**GENERAL VENDING
SALES CORP.**

306 N. Gay Street Baltimore 2, Md.

Distributed in Oklahoma by

**CLIFF WILSON
DISTRIBUTING CO.**

1121 South Main Street Tulsa, Okla.
119 South Walker Street Okla. City, Okla.

Distributed in Illinois, Iowa, Indiana
and Wisconsin by

PELL PRODPCTS CO.

2000 N. Oakley Chicago, Ill.

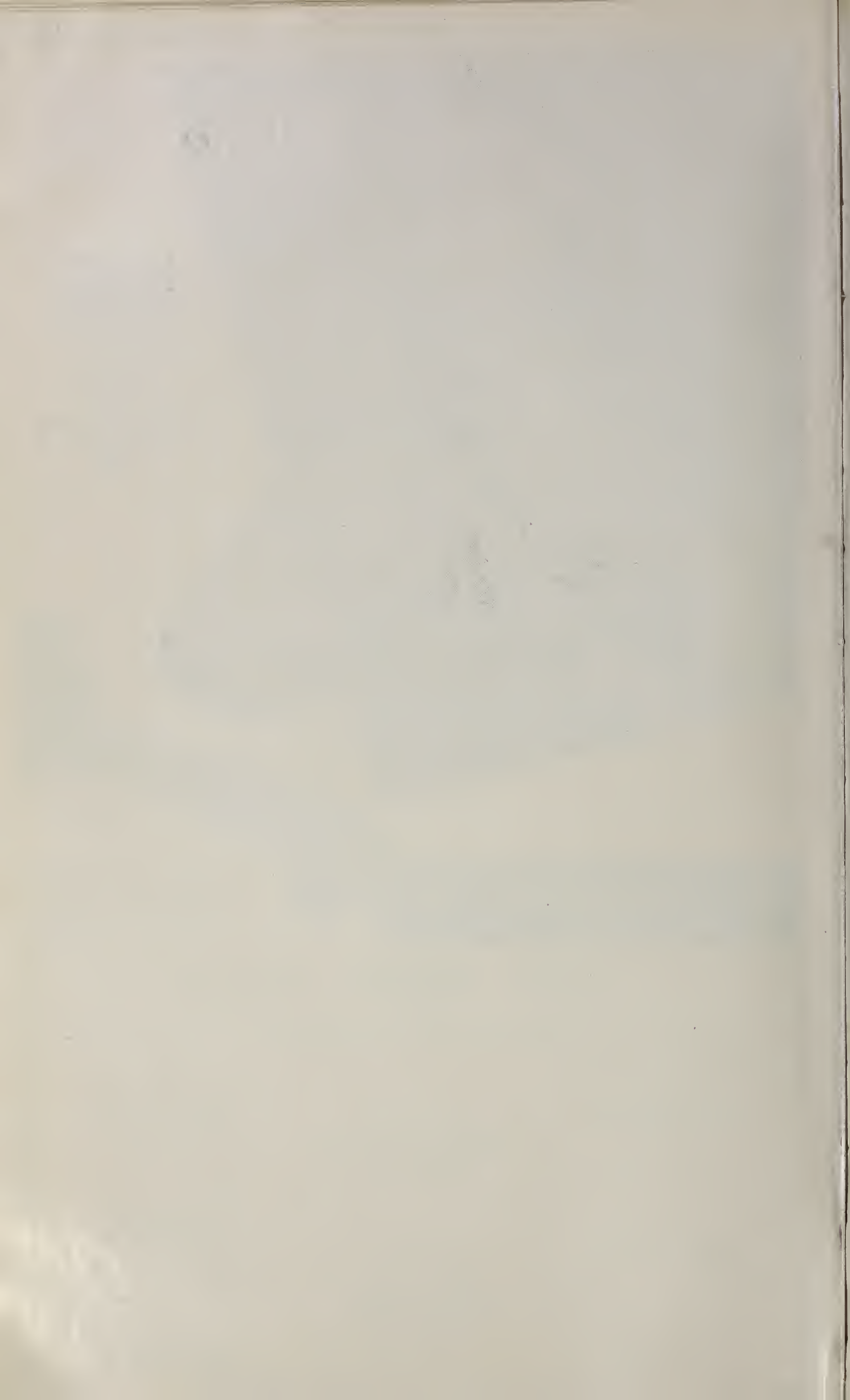

HARD TO GET PARTS

SATISFACTION GUARANTEED OR YOUR MONEY BACK



MAGAZINE SWITCH BOX ASSEMBLY



OILER

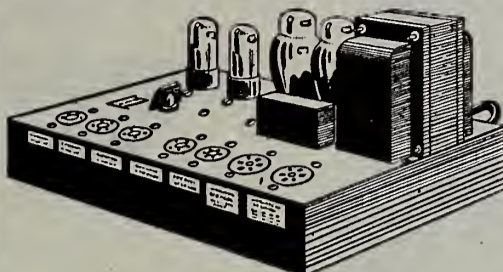

UNIVERSAL AMPLIFIER



CASTER

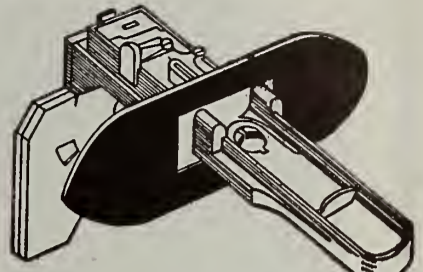

COIN CHUTE

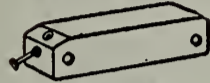

B-2 CRYSTAL PICK UP

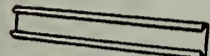

PROGRAM TIN "TITLE STRIP HOLDER"



MAIN FIBRE GEAR



TURN TABLE BUSHING



NEEDLE SCREW



VOLUME CONTROL KEY



STAR WHEEL PIN



TRIP DOWN WIRE

JOBBER and DISTRIBUTORS, write for Quantity Prices

Wurlitzer Turntable Bushings (Brass). Ea. \$1.00	Wurlitzer Needle Screws, Case Hardened. Per Doz. \$1.50
Wurlitzer Main Fiber Gears. Ea. 3.95	Seeburg Needle Screws, Long and Short, Specify. Per Doz. 1.50
Title Strip Holders or Program Tins. Ea.10	Casters, Standard Wur. Size. Set of 4 1.85
Star Wheels. Ea.35	Casters, Large Size, Fit Any Phonograph, Set of 4 1.65
Star Wheel Pins or Dumbbells. Ea.35	Wurlitzer Trip Down Wire. Ea.40
Shielded Wire for Tone Arm. Per Ft., 8¢; 15 Ft.75	Volume Control Keys, Polished. Ea. 5¢; Per 100 4.50
Micro Switches, Red and Green on Same Switch; connect leads to whichever color you want—only one switch to stock. Perfect for all Rock-Olas and Wurlitzers. Ea. \$1.15; Per Dozen \$12.00	Brand New Coin Chute Assemblies, single coin only, to replace entire 3 Coin Chute Assemblies on 412 and 818. Complete. Ea. \$11.95
B-2 Crystal Pick Ups (Black Type) for Rock-Ola and Mills. Ea. \$3.25; Per Dozen 36.00	"Lifetime" Pressure Oiler, a coin machine operator's "Must." Ea. 2.95
Brand New, Original Wurlitzer Magazine Switch Box Assemblies, Complete with Cover for 412, 618, 24A, 600A, 500. SPECIFY MODEL. Ea. 9.95	Universal Amplifiers—Ask the Operator who owns one. Model A fits all Wurlitzer models, all Rock-Olas, all Seeburgs except Hi-Tone. Complete with tubes. Ea. 54.50
	Model B fits all Wurlitzers, all Rock-Olas and all Seeburgs including Hi-Tones. Complete with tubes. Ea. 74.50

1/2 CERTIFIED DEPOSIT MUST ACCOMPANY ALL ORDERS

HEATH DISTRIBUTING COMPANY

217 Third St. - Phone 2681
MACON, GEORGIA

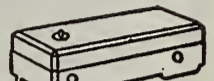

MICRO SWITCH



SHIELDED WIRE



STAR WHEEL

A KENTUCKY MUSIC OP SOUNDS OFF

70%-30% AMONG OUTSTANDING NEEDS OF THE INDUSTRY

But Co-operation Among Ops Is Its Key

COVINGTON, KY.—In a statement received by *The Cash Box* this week, John M. Weisenberger, music operator of the Kentucky Service Company, this city, writes his views on present problems confronting music operators and what he believes to be the remedy. His letter is reprinted below.

"The cost of operation has doubled in the past few years, and we are only kidding ourselves if we don't sit down and face the issues as they are. Wishful thinking will not work the problem of a thousand dollar installation when you find twelve or fourteen dollars a week in the cash box. Too many operators are going along without pausing to consider if they are really earning money or whether they are just paying for their equipment.

"I am very much in accord with articles dealing with the necessity of raising the percentages of the operator a 70-30 basis — it means much more money for all of us. I agree that at this time it is one of the outstanding needs of the industry.

"But let us stop to consider what is really necessary before it can be accomplished.

"Any operator knows full well what would happen to him if he raised his percentage with a location. The locations have been educated to expect fifty percent of the gross. They get it on games and other equipment. They know that by the simple process of calling your competitor and showing him their collection slips that he would give them whatever they wanted.

"What to do about it. There is to my mind only one thing that can be done; that is organized co-operation. I believe it is the duty of every operator in this business to join his local association and union. When these organizations become strong enough we can speak with real effect and raise the rates of locations.

"There is no doubt that there is an abundance of good minds in this business. Most of its successful men started at the bottom and came up the hard way. They have lived through the cut-throat era and they want no further part of it. And of all the successful men I have met in the industry I have yet to meet one who was not one hundred per cent for organization.

"To me, the proper intelligent

"SMILEY"

WILL BE HERE!

Available Soon

from

Your Nearest Distributor!

MANUFACTURERS

PIONEER COIN MACHINE CO.

2634 N. LARAMIE AVENUE

Chicago 39, Ill.

National 2727

"Pioneer" will Pioneer

FIBER GEARS PARTS FOR WURLITZERS

Main Fiber Gears \$4.00 - Star Wheels 30c Each
Selector Pins or Dumbbells; 1 Doz. \$3.00
Ball Shooters or Plungers for all Pin Ball Machines — 1 Dozen \$5.00.

For Quantity Prices, Write To:

JAMES CLEMENT - Mfg. of Coin Mach, Parts
948 W. Russell Street Philadelphia 40, Pa.

management of a route, plus a wide awake attitude in the quest for new locations will get us much farther than sneaking around our competitor's locations, trying to undermine him and causing him to do the same with our own.

"To all operators, I say, join your local association, meet with your fellow operators not as enemies but as men engaged together in a great industry, all striving for the same end, a decent living, a guaranteed future and the friendship and respect of everyone."

BLACK CHROME CABINETS

Brand New Complete, only - - **\$29⁵⁰**

GOLD or COPPER CHROME CABINETS

Brand New Complete, only - - **\$29⁵⁰**

GENUINE SILVER CHROME CABINETS

Brand New Complete, only - - **\$39⁵⁰**

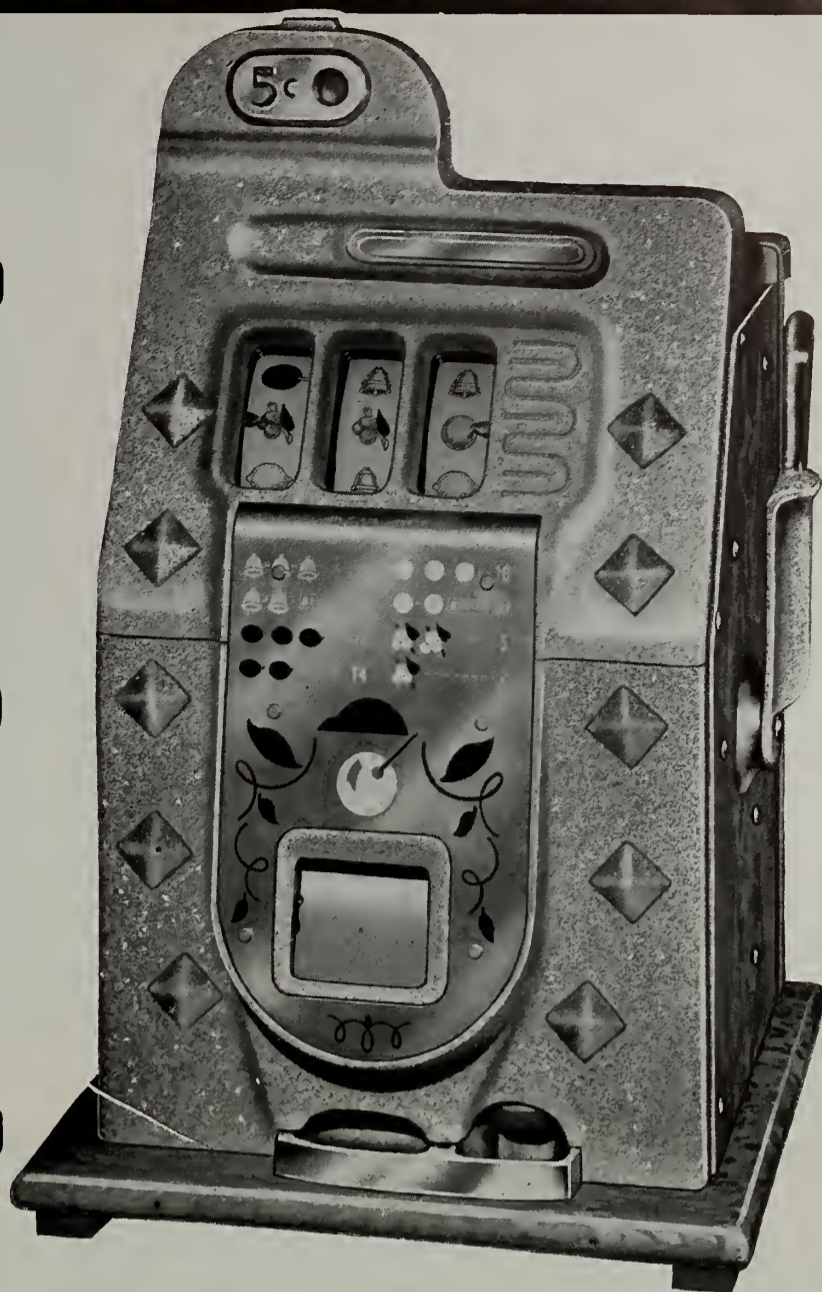

These New Features Included in All Chrome Cabinets:

- Light, Durable Wood Cabinet
- Drill Proof Lining
- Chrome Castings (gold, copper or silver)
- Metal Reward Plate
- Club Handle
- Denominator
- Knee Action
- Unbreakable Jackpot Glass

Fit All Mills Escalator Type Machines

Specify 5c, 10c or 25c play; 2/5 or 3/5 Pay.

REBUILDING

of any
MILLS ESCALATOR TYPE MACHINES
and placed in a
BRAND NEW CHROME CABINET

Will Look and Operate
LIKE NEW!

- Completely Rebuilt
- Completely Refinished
- Completely Rejuvenated

WE WILL NOT BE UNDERSOLD!!

for only

\$69⁵⁰

Complete

PLUS PARTS

Choice of Silver -
Gold - Copper - Black Chrome

Here is the opportunity you've been looking for to make your MILLS ESCALATOR TYPE MACHINES look and operate as good as NEW. We will completely rebuild your machines under the supervision of factory trained mechanics. ALL OUR WORK GUARANTEED. SEND YOUR MACHINES AT ONCE. VERY PROMPT DELIVERY. The cabinets furnished include all the features above.

American Amusement Co.

4047 W. FULLERTON AVE., CHICAGO 39, ILLINOIS • CAPITAL 5300

"IF YOU MISS US - YOU MISS MAKING MONEY"

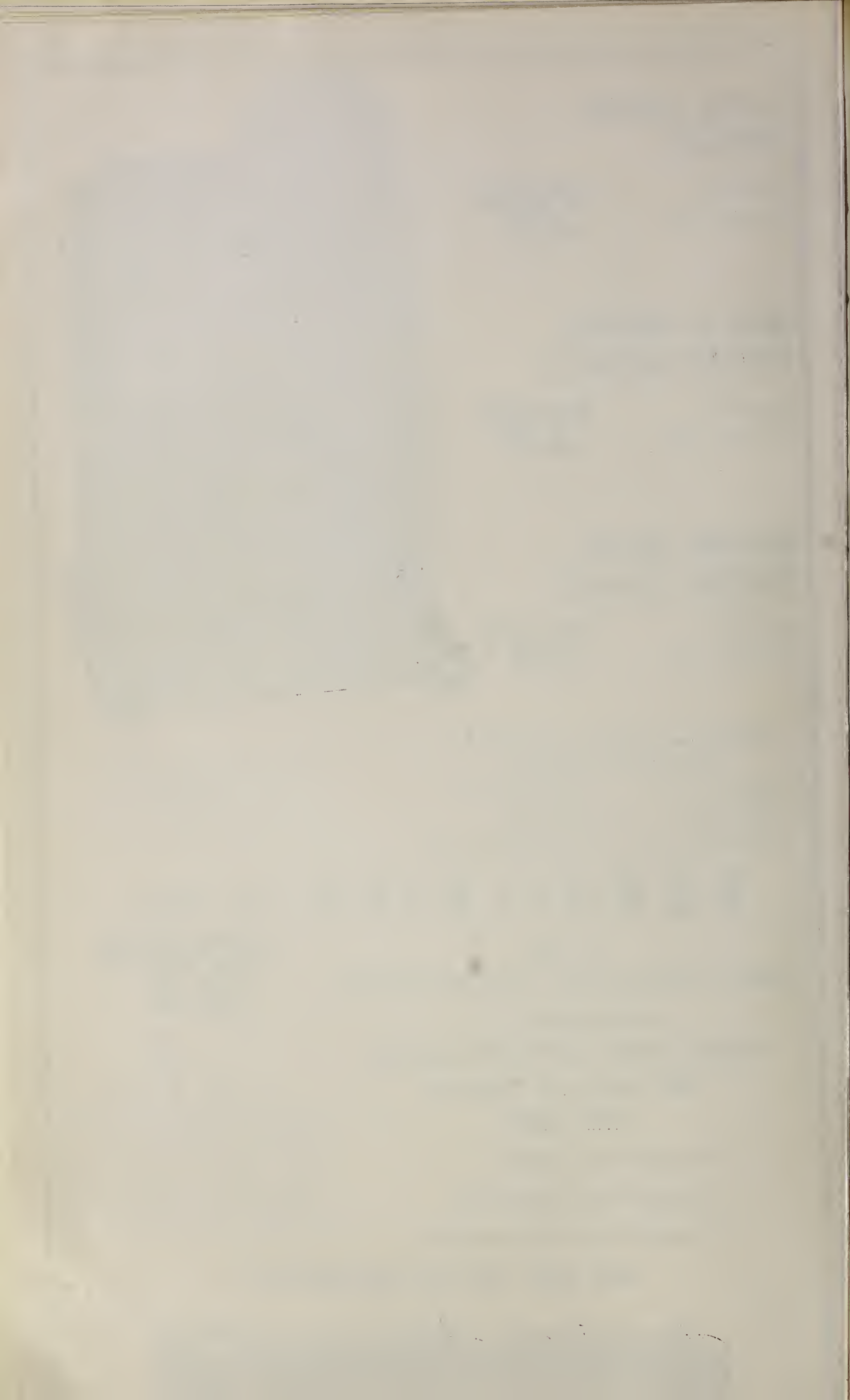

IT MUST BE GOOD

GOALEE

CHICAGO COIN'S

HAS SUCH A TREMENDOUS EARNING POWER OPERATORS CAN'T STOP PRAISING

The **ONE OR TWO NICKEL PLAY**
5¢ OR 10¢ EACH GAME

CHICAGO COIN MACHINE CO.
1725 DIVERSEY BOULEVARD • CHICAGO 14, ILLINOIS

PRODUCTION IS LIMITED .. ORDER TODAY FOR EARLIEST DELIVERY

COIN OPERATED HOBBY SHOP IS HERE

LOUISVILLE, KY.—Now it's a coin-operated hobby shop that makes its appearance, if the well laid plans of three local citizens come off as planned.

Owners of the unique establishment are Mr. and Mrs. William Cartledge and George H. Hair, and their business is called "Everybody's Workshop." It operates this way:

There is a space of 9,000 square feet fitted with 30 work benches, 20 individual tool boards and plenty of equipment. In this layout the customer-hobbyist sits himself down at say one of the 11 power tools to work on some phase of a sailboat he's building. The prices vary slightly but the average machine will operate five minutes if a dime is pushed into the coin chute. When the dime runs out, so does the power. There's also a quarter chute that runs the motor for thirty minutes.

In addition, coin chutes and timers are to be installed on a bench saw, band saw, jig saw, joiner, wood shaper, drill press, disc sander and other equipment in a few weeks.

All parties concerned with the venture have put so much time and money into the project, "we don't even know what our investment amounts to," but they are optimistic about its future. One customer made eight screen door frames in two nights.

THE NEW

AMI

PHONOGRAPH IS ON THE WAY!

WATCH FOR OUR ANNOUNCEMENT!

DAVID ROSEN
855 N. BROAD ST. PHILADELPHIA 23, PA.
STEVENS ON 2258

APOLLO RECORDS NAMED MICROTONE DISTRIB

STAMFORD, CONN. — Apollo Records Distributing Company, New York City, have been appointed distributors for Microtone's Loranium coin machine needle, it was recently announced by E. B. Murphy, president of the Microtone Company, this city.

Within the last thirty days Micro-

tone has changed its needle design so that the new product is scientifically designed for use in all machines.

Microtone was awarded the Navy's Certificate of Achievement by Secretary Forrester for outstanding production of phonograph needles for the armed forces.

[Faint, illegible text, likely bleed-through from the reverse side of the page.]

[Faint, illegible text, likely bleed-through from the reverse side of the page.]

The Automatic Instrument Company

cordially invites

All Operators, Distributors and Manufacturers

to attend the

Premiere Showing

of the New

A·M·I PHONOGRAPH

April 10th and 11th, 1946

10 a. m. to 10 p. m.

in the Tropical Room

Hotel Continental

505 North Michigan Avenue

Chicago, Illinois

Buffet and Refreshments

Special Program Featuring Celebrities and Surprises

“Everybody Together!”

The first part of the book is devoted to a general introduction to the subject of the history of the world.

The second part of the book is devoted to a detailed account of the history of the world from the beginning of the world to the present time.

The third part of the book is devoted to a detailed account of the history of the world from the present time to the future.

THE HISTORY OF THE WORLD

The fourth part of the book is devoted to a detailed account of the history of the world from the future to the end of the world.

The fifth part of the book is devoted to a detailed account of the history of the world from the end of the world to the beginning of the world.

The sixth part of the book is devoted to a detailed account of the history of the world from the beginning of the world to the end of the world.

The seventh part of the book is devoted to a detailed account of the history of the world from the end of the world to the beginning of the world.

The eighth part of the book is devoted to a detailed account of the history of the world from the beginning of the world to the end of the world.

The ninth part of the book is devoted to a detailed account of the history of the world from the end of the world to the beginning of the world.

*Immediate
Delivery!*

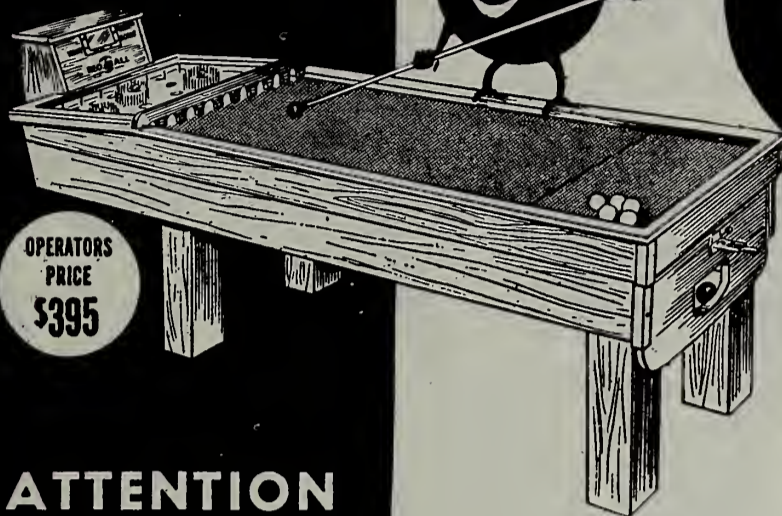

OPERATORS
PRICE
\$395

ATTENTION
LIVE WIRE
DISTRIBUTORS

WRITE FOR EXCLUSIVE IN
YOUR TERRITORY, YOU NEVER
SOLD ANYTHING SO FAST,
SO NEW, SO DIFFERENT AND
SO PROFITABLE

IT'S NEW, IT'S DIFFERENT, IT'S PROFITABLE

RED-BALL
THE NEW GAME
SENSATION

NOTHING ELSE
LIKE IT!
THEY CAN'T RESIST
TO PLAY IT!

- GROSSES OVER \$95.00 A WEEK
- YOU ONLY HAVE TO PAY 40% COMMISSION
- WILL PAY FOR ITSELF IN EIGHT WEEKS
- OVER 100 MACHINES ON TEST LOCATION FOR SEVEN MONTHS

THIS GAME WAS PLAYED ALL OVER THE WORLD DURING THE WAR. THOUSANDS SOLD TO THE ARMY, NAVY, RED CROSS AND U.S.O. CLUBS

ASK ANY GI

EXCLUSIVE NATIONAL DISTRIBUTORS

HIRSH COIN MACHINE COMPANY

1309 New Jersey Ave. N.W., Washington, D. C.

Phone HO. 3170

MICHIGAN LCC HOLDS OPS' PLEA UNDER ADVISEMENT

LANSING, MICH. — Following thru in the general protest to the recent ruling of the Michigan State Liquor Control Commission barring coin operated games from tavern premises, the LCC last week received a request from amusement operators that miniature bowling games, dart games, and shuffle boards be permitted

The LCC now has that request under advisement.

In the meanwhile, the commission ruling that no type of gaming equipment be used in any licensed establishment, remains in suspense pending the return of Commissioner Felix H. H. Flynn from a Florida vacation, it was announced by John P. Aaron, commission chairman.

As mentioned recently in *The Cash Box* (Week of March 18, 1946), what did win the commission to a halt in further removal of machines was the plea of many returned veterans who had entered into the coin machine industry. They pointed out that this was their only means of livelihood and that they had invested all their monies in this business.

PAY FEDERAL SLOT TAX

LOUISVILLE, KY.—The Federal tax on slot machines was recently paid by six additional operators, it was reported recently by *The Times*, a leading newspaper here.

This latest payment brings the total for Jefferson County to 288 machines and 196 taxpayers during the present fiscal year.

**CENTRAL OHIO COIN MACHINE EXCHANGE
WILL PURCHASE FOR CASH
WILL PAY HIGHEST PRICES**

FOR
PINBALLS — CONSOLES — PHONOGRAPHS
SLOTS — ARCADE EQUIPMENT
NO DEAL TOO LARGE OR TOO SMALL
CENTRAL OHIO COIN MACHINE EXCHANGE

NEW ADDRESS

185 Town Street

Columbus, Ohio

(Phone: Adams 7949-7993)

KANSAS DISTRIBUTORS FOR

- AIREON ELECTRONIC PHONOGRAPH
- PACE'S DRILL PROOF DE LUXE CHERRY BELL
- CHICAGO COIN'S GOALEE
- WILLIAMS LAURA AND SUSPENSE
- ADVANCE VENDORS

RECONDITIONED CONSOLES AND SLOTS • DUGRENIER CIGARETTE VENDERS

MATHENY VENDING CO., INC.

564 W. DOUGLAS

WICHITA 12, KANSAS

PINS AND JUKE ROBBED

BUFFALO, N. Y.—Rifling two pin ball machines, a juke box and a safe, burglars hauled in a take that ranged between \$2500 and \$3000 when they sacked a tavern located in this city, recently.

They forced a rear window to make their entry, battered open the safe located in the kitchen and cracked open the cash boxes of the coin operated equipment, then they left by a side door.

Frank Colangelo operates the tavern located at 381 Busti Ave., here.

We Have For Immediate Delivery

Mills New Postwar Bell
BLACK CHERRY

It is the most attractive bell machine ever offered to the operator. Important improvements have been incorporated in the mechanism which will prove beneficial to all coin machine users for a long period of time.

5c - 10c - 25c - 50c PLAY

Place Your Order Today to Insure Preferred Delivery.

We have all repair parts for Mills Slot machines. Write for complete price list.

Established 1895

50 years of service

SICKING, INC.

1401 Central Parkway

Cincinnati, Ohio

IT'S THE WAY IT'S DONE, IT'S THE WAY IT'S DONE

RED-BALL

GENERAL INFORMATION

- THE ONLY BALL MADE IN AMERICA
- THE ONLY BALL MADE OF RUBBER
- THE ONLY BALL MADE OF PURE RUBBER
- THE ONLY BALL MADE OF PURE RUBBER



THE ONLY BALL MADE IN AMERICA
THE ONLY BALL MADE OF RUBBER
THE ONLY BALL MADE OF PURE RUBBER

ASK ANY GI

ATTENTION

THE ONLY BALL MADE IN AMERICA
THE ONLY BALL MADE OF RUBBER
THE ONLY BALL MADE OF PURE RUBBER

HIGHEST PAY HIGHEST PRICES

WILL PAY HIGHEST PRICES
WILL PAY HIGHEST PRICES
WILL PAY HIGHEST PRICES

WILL PAY HIGHEST PRICES
WILL PAY HIGHEST PRICES
WILL PAY HIGHEST PRICES

WILL PAY HIGHEST PRICES

WILL PAY HIGHEST PRICES
WILL PAY HIGHEST PRICES
WILL PAY HIGHEST PRICES

WILL PAY HIGHEST PRICES
WILL PAY HIGHEST PRICES
WILL PAY HIGHEST PRICES

WILL PAY HIGHEST PRICES
WILL PAY HIGHEST PRICES
WILL PAY HIGHEST PRICES

WILL PAY HIGHEST PRICES

WILL PAY HIGHEST PRICES
WILL PAY HIGHEST PRICES
WILL PAY HIGHEST PRICES

WILL PAY HIGHEST PRICES

"DUCKY"

1800 R. M. Holes... 5c Play
 Takes In..... \$90.00
 Pays Out..... 47.06
PROFIT..... \$42.94

HARLICH'S Newest

"IN THE DARK"

960 G. L. Holes... 10c Play
 Takes In..... \$96.00
 Pays Out..... 46.48
PROFIT..... \$49.52

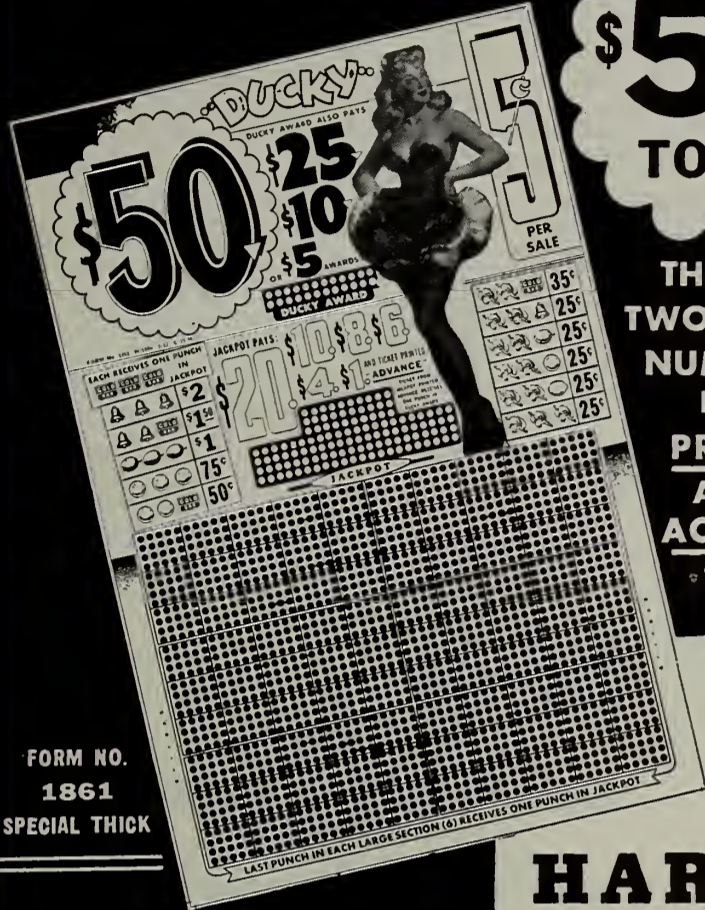

**\$50
TOPS!**

**THEY'RE
TWO SWEET
NUMBERS
FOR
PROFIT
AND
ACTION
!!!**



FORM NO. 936
SPECIAL THICK

HARLICH MANUFACTURING CO.

1417 W. JACKSON BLVD.
CHICAGO 7, ILLINOIS

**READY NOW!
OUR NEWEST CATALOG
SEND FOR IT TODAY!**

**READY SOON!
OUR NEW MILLION
DOLLAR PLANT!**

ATTENTION!! OPERATORS IN NORTHWESTERN PENNA.!

WE ARE SHOWING

ROCK-OLA

The
PHONOGRAPH
OF TOMORROW



The FORD HOTEL
Erie, Pa.

ON
APRIL 6th and 7th

Don't Fail To See It!

B. D. LAZAR COMPANY

1635 FIFTH AVENUE

(ALL PHONES: GRant 7818)

PITTSBURGH, PENNA.

HELP WANTED-PARKING METER ATTENDANTS

INDIANAPOLIS, IND. — Applicants for jobs as parking meter tenders were few and far between at the city personnel office here, when it was learned that the job entailed more than just making the rounds to empty them of the anticipated \$3000-a-week take.

They realized that it wasn't going to be like a slot player's honeymoon, when it was learned that the attendants would also have to crank the time clocks in all the meters, for it seems the salesmen forgot to stress this little(?) feature.

So as things stand at present, it's still "Help Wanted — Meter Collectors."

A NEW REVAMP!

CATALINA

MARVELS LATEST 5 BALL FREE PLAY

**YOU LIKED HOLLYWOOD — EVERYBODY DID!
WAIT 'TILL YOU SEE CATALINA! GET YOUR ORDER
IN WITHOUT DELAY. DON'T BE DISAPPOINTED!**

\$249.50
F.O.B. CHICAGO

MARVEL MANUFACTURING CO.
2122 MILWAUKEE AVE., CHICAGO 47
PHONE: EVERGLADE 0230

See your Dis-
tributor. Phone,
Wire or Write
to Us Direct.

Juke Box In Mothers Club

PEEKSKILL, N. Y. — A juke box

has been installed in the recreation hall of the Assumption Mother's Club, this city, it was recently announced.



WANTED

WANTED
REWARD \$1000
FOR THE ARREST OF
JAMES EARL RAY
FUGITIVE
MAY 1968

WANTED
REWARD \$1000
FOR THE ARREST OF
JAMES EARL RAY
FUGITIVE
MAY 1968

WANTED
REWARD \$1000
FOR THE ARREST OF
JAMES EARL RAY
FUGITIVE
MAY 1968

BADGER'S BARGAINS

"OFTEN A FEW DOLLARS LESS — SELDOM A PENNY MORE"

MILWAUKEE
See CARL HAPPEL

LOS ANGELES
See BILL HAPPEL

KEENEY RECONDITIONED SUPER BELLS

Completely Rebuilt and Refinished Like New

Keeney Super, 5c, F.P., P.O. \$325.00	Keeney 4-Way, 5c-5c-25c-25c, P.O. 595.00	Keeney Twin, 5c-25c, F.P., P.O. 595.00
Keeney Super, 25c, F.P., P.O. 375.00	Keeney 4-Way, 25c-25c-25c-25c, P.O. 625.00	Keeney Twin, 25c-25c, F.P., P.O. 625.00
Keeney 4-Way, 5c-5c-5c-5c, P.O. 495.00	Keeney Twin, 5c-5c, F.P., P.O. \$595.00	Keeney Twin, 5c-5c, P.O. 375.00
Keeney 4-Way, 5c-5c-5c-25c, P.O. 595.00		Keeney Twin, 5c-25c, P.O. 395.00
		Keeney Twin, 25c-25c, P.O. 450.00

RECONDITIONED CONSOLES

Mills Late Head 4 Bells, 5c-5c-5c-25c \$695.00	Mills Original 4 Bells, 5c-5c-5c-25c 595.00	Bally Club Bells, F.P., P.O., 5c 239.50
Evans Bang Tails, Late D.D., J.J. 295.00	Pace Saratoga, Late P.O., 25c 189.50	Jennings Silver Moon, P.O. 129.50
Evans Dominoes, Late D.D., J.P. 295.00	Mills Original Head, Four Bells 375.00	Mills Jumbo, Late High Head, P.O. 149.50
Evans Lucky Lucre, 3-5c, 2-25c 295.00	Mills Three Bells, 5c-10c-25c \$795.00	Mills Jumbo, Late High Head, F.P. 129.50
Evans Lucky Lucre, 5-5c 195.00	Pace Reels Twin, 5c & 25c, P.O. 395.00	Baker Pacers, Daily Double, 5c 299.50
Bally Roll 'Em 139.50	Bally Hi Hands, F.P., P.O. 199.50	Pace Saratogas, Late, P.O., 10c 169.50
Evans Lucky Stars 139.50	Mills Late Head 4 Bell, 5c-5c-5c-5c 595.00	Mills Jumbo (Comb.), F.P., P.O. 213.75
Pace Saratogas, Late P.O., 5c 99.50		

ONE-BALL MULTIPLE FREE PLAY TABLE

Rebuilt and Refinished

Keeney Sky Lark \$139.50	Baily Dark orse 159.50	Bally '41 Derby 225.00
Baily Pimlico 295.00	Bally Thorobred \$374.50	Bally Blue Grass 159.50
Baily Trophy 225.00	Bally Longacre 374.50	Mills '41 1-2-3 79.50
Baily Sport Special 139.50		

PHONOGRAPHS AND WALL BOXES

Rock-Ola Commando \$650.00	Buckley 24 Ill. Boxes 24.50	Wurlitzer Model 616, Ill. 249.50
Rock-Ola Super Rock-O-Lite 495.00	Rock-Ola Premier \$595.00	Wurlitzer Victory Model 500 595.00
Rock-Ola Master, Rock-O-Lite 475.00	Wurlitzer Model 780E 795.00	Packard Pla-Mor, Like New 32.50
Rock-Ola Imperial Rock-O-Lite 295.00		

BADGER SALES COMPANY

Exclusive Distributors for

J. H. KEENEY & COMPANY
ROCK-OLA MFG. CORPORATION

Southern California, State of Arizona and Southern Nevada
1612 WEST PICO BLVD., LOS ANGELES 15, CALIF.
All Phones: DR. 4326

BADGER NOVELTY COMPANY

Exclusive Distributors for

J. H. KEENEY & COMPANY
ROCK-OLA MFG. CORPORATION

State of Wisconsin and Northern Michigan
2546 NORTH 30th STREET, MILWAUKEE 10, WIS.
All Phones: KIL. 3030

WAR HERO PUTS NEW ZIP IN JUKE BOX CANTEEN

LONG ISLAND CITY, N. Y. — A community - sponsored Juke Box Canteen was given a new lease on life here recently when a war hero was named to take over its direction.

Attendance had been sagging for several months when the canteen sponsors hit upon the idea of replacing feminine directors with a veteran. He'd be a drawing card, the sponsors believed, especially if he had a lot of ribbons.

And they were right.

Following shortly the appointment of 21-year old William M. Agin, who had just been released from the Seabees after 30 months services, including eighteen in the South Pacific, membership hit a new high of 270 paid up teen-agers.

Agin took over the canteen, housed in four rooms located in the heart of this city, and since then things have been humming six days and nights a week. Members pay five dollars a year dues to help meet operating expenses, including the young director's salary.

With the juke box setting the stage for dancing and other activities, the youngsters, aged 13 to 19, gather there afternoons at 3:30 and stay to 5:30; then there's more activity from 7:30 to 9:30 P.M., Mondays thru Thursdays and until 11:30 P.M. on Friday and Saturday nights.

MUSIC BOXES

MONEY BACK GUARANTEE

1 600 Rotary \$450.00
1 600 Remote 500.00
1 24 Remote 385.00
1 Victory 24 495.00
1 24 Rotary 335.00

These can be had on or off location.
The two remotes have 8 wall boxes each and Speakers 30-wire jobs.

WE WANT LONGACRES

Victory Sales Co.

1100 HARFORD AVE., BALTIMORE 2, Md.
JOHNNIE LA PORE
now with JACK BERGER

ANGRY AT SLOT, HE SMASHES IT WITH SHOT

CARLINVILLE, ILL.—Curtis Brantley of Fosterburg was arrested in Brighton recently following a disturbance he is alleged to have caused. According to information given the local newspaper here, Brantley had become incensed when a slot machine in a Brighton tavern failed to pay off. He returned later with a .22 calibre rifle and proceeded to riddle the machine.

Brought before the county court here, Brantley pleaded guilty on charges of assault with a deadly weapon and disturbing the peace; he was fined \$100 and costs and \$10 and costs, respectively.

ATTENTION . . .

OPERATORS IN

- ★ WESTERN PENNSYLVANIA
- ★ NORTHERN WEST VIRGINIA
- ★ SOUTHEASTERN OHIO

The New Mills Black Cherry Bells now available 5c - 10c - 25c

IMMEDIATE DELIVERY

Mills Brand New Vest Pockets, Fruit Reels — 5c Play.....\$74.50

— WANTED —

Super Bells Saratogas, F.P. Comb.
Pace Reels, F.P. Comb. Pin Games

WIRE — PHONE — WRITE NOW

COIN MACHINE DISTRIBUTING CO.

500 N. Craig St. Pittsburgh 13, Pa.
(Museum 0303-04)

WANT TO BUY!

SUPER BELLS, COMB. SILVER MOONS, F.P.
SUPER BELLS TWIN, '41 DERBY
5/25 COMB. PIMLICO
HI HANDS CLUB TROPHY
THREE BELLS LONGACRES
JUMBO PARADES, F.P. THOROBREDS

Write — Wire — Phone Today!

Advise Condition, Quantity & Best Price!

H. ROSENBERG CO.

625 10th Ave. (LO. 3-2479) N. Y. 19

WIRE — CABLE

2 Conductor underwriters approved	
No. 18 Zip Cord.....per 1,000 ft.	\$18.00
2 Conductor underwriters approved No. 18	
Silk & Rubber Covered Wire...per 1,000 ft.	18.00
5 Conductor heavy duty rubber covered gun	
cable for Seeburg guns.....per ft.	.18

ATLAS VENDING COMPANY

410 No. Broad St. Elizabeth, N. J.

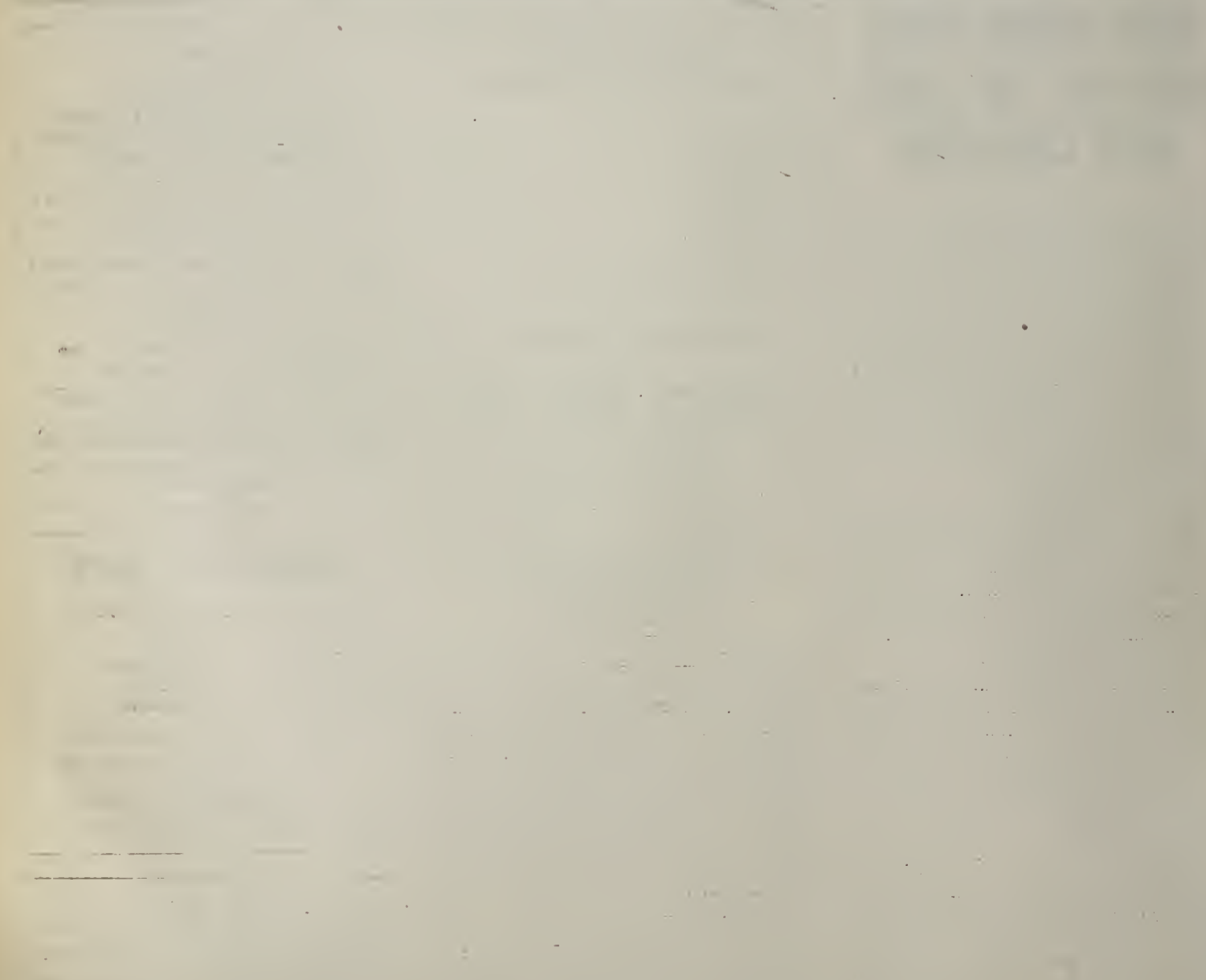
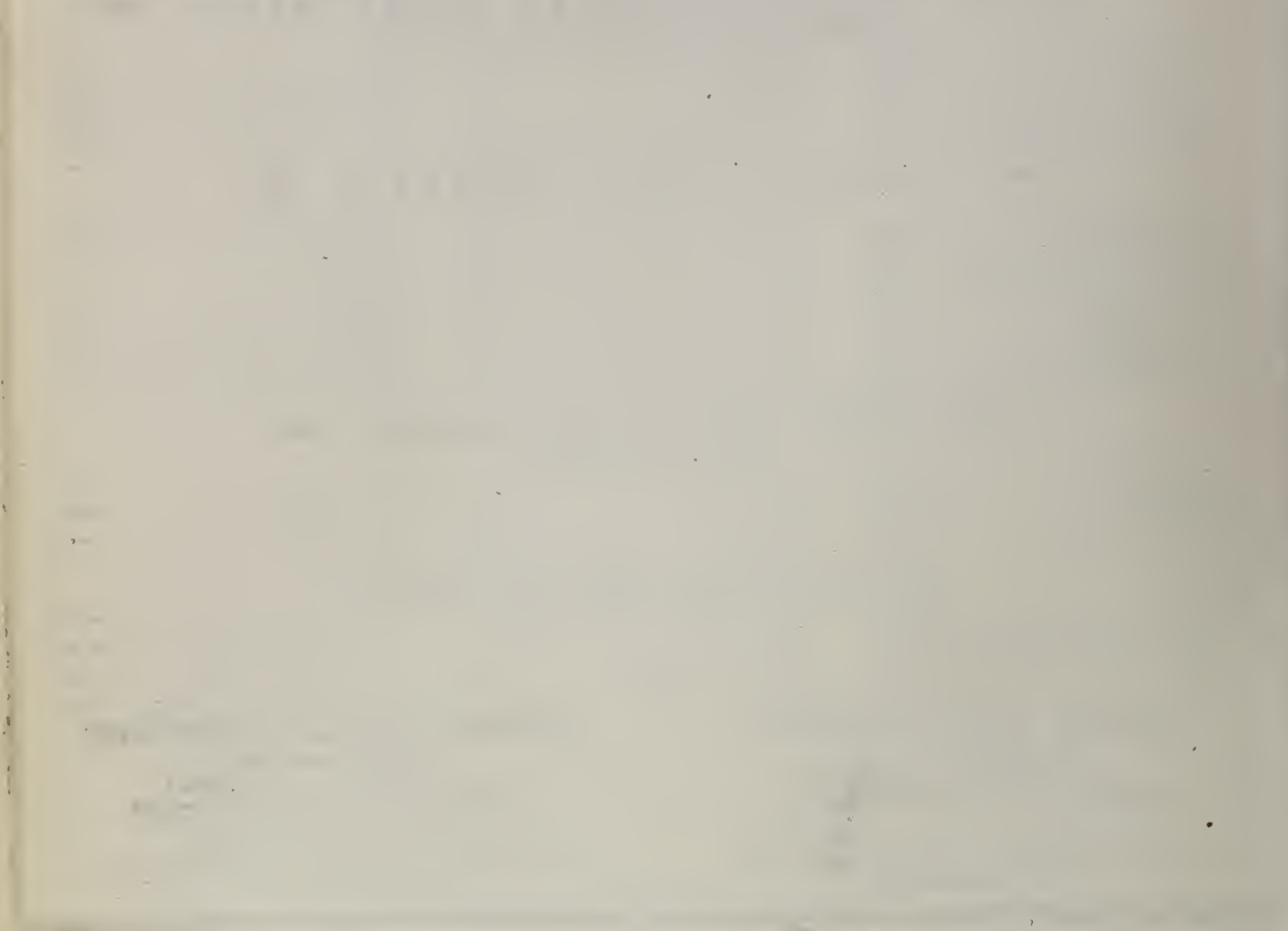
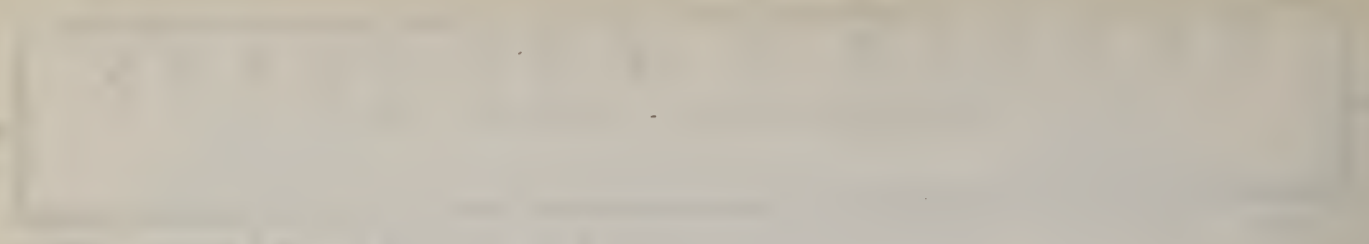

SUPER DE LUXE CLUB CHIEF

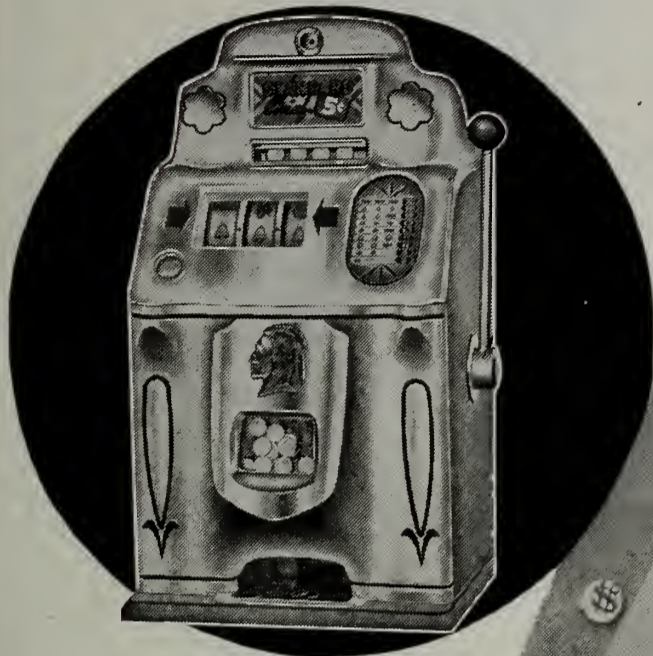

STANDARD CHIEF

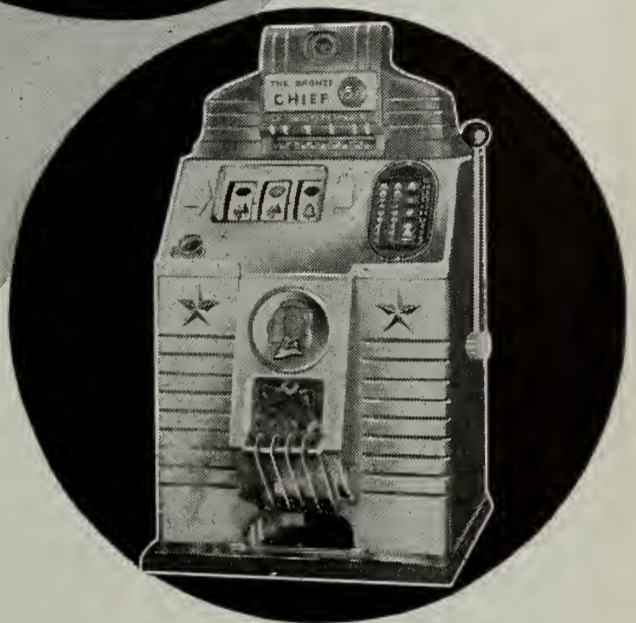
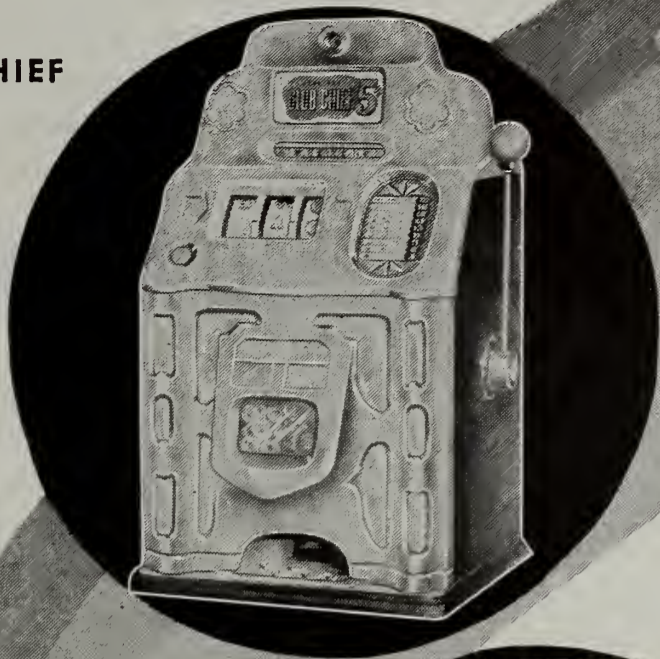

BRONZE CHIEF



Within Your Grasp!

That Pot of Gold at rainbow's end can be yours with these sensationally new Jennings' machines.

See any of the three models shown above at your dealer or distributor...or write to us for folder. Why buy "Just a slot machine"—buy the BEST!...

IT'S A NEW JENNINGS' CHIEF!

O. D. JENNINGS & COMPANY

4307-39 WEST LAKE STREET CHICAGO 24, ILL.

PLATE I



FIGURE 1



FIGURE 2

Stropharia glauca (Fr.) Sacc.

Stropharia glauca (Fr.) Sacc.
This fungus is characterized by its
globose, smooth, and shining
fruiting bodies, which are
usually found in clusters.
The spores are globose and
smooth-walled.



PLATE I



\$349⁵⁰

F.O.B., N.Y.

MUNVES' "SUPER ROLL"

All the necessary qualities for good, money-making equipment are combined in this tried and tested game. If you want a winner . . . if you want to be sure of the best . . . you want the "King of Alleys" . . . Munves' "Super Roll".

NATIONAL DISTRIBUTORS

RUNYON SALES CO.

OF NEW YORK, INC.

593 - 10th AVE. (PHONES: LONG 3-4820 - 4836) N. Y. 18

ORDER NOW FROM THE COUNTRY'S FOREMOST DISTRIBUTORS

RUNYON SALES CO.
123 W. RUNYON STREET
NEWARK, N. J.

RUNYON SALES CO. of N. Y.
593 TENTH AVENUE
NEW YORK CITY

BADGER NOVELTY CO.
2546 NORTH 30th STREET
MILWAUKEE, WISC.

AMERICAN COIN-A-MATIC MACHINE CO.
1435 FIFTH AVENUE
PITTSBURGH, PA.

ATLAS VENDING CO.
410 NO. BROAD STREET
ELIZABETH, N. J.

RUNYON SALES CO.
1290 DELAWARE AVENUE
BUFFALO, N. Y.

CLARENCE BAGGETT
915 NORTH 21st STREET
OKLAHOMA CITY, OKLA.

CALIFORNIA AMUSEMENT CO.
1348 VENICE BOULEVARD
LOS ANGELES, CALIF.

1175 FOLSOM ST., SAN FRANCISCO, CALIF.

ROTH NOVELTY CO.
54 PENNSYLVANIA AVENUE
WILKES-BARRE, PA.

J. J. GOLUMBO & CO.
116 NEWBURY STREET
BOSTON, MASS.

MARLIN EQUIPMENT CO.
412 NINTH STREET, N. W.
WASHINGTON, D. C.

SILENT SALES CO.
200 ELEVENTH AVE., SO.
MINNEAPOLIS, MINN.

THE MARKEPP COMPANY
4310 CARNEGIE AVE., CLEVELAND 3, OHIO

EMPIRE COIN MACHINE EX.
2812 W. NORTH AVENUE
CHICAGO, ILL.

HEATH DISTRIBUTING CO.
217 THIRD STREET
MACON, GEORGIA

SOUTHWEST AMUSEMENT CO.
2916 MAIN STREET
DALLAS, TEX.

LOUISIANA COIN MACHINE SERVICE CO.
931 POYDRAS STREET
NEW ORLEANS, LA.

JULES OLSHEIN CO.
1100 BROADWAY
ALBANY, N. Y.

BIRMINGHAM VENDING CO.
2117 THIRD AVE., NO.
BIRMINGHAM, ALA.

MODERN SOUTHERN DIST. CO.
459 RIVERSIDE AVE.
JACKSONVILLE, FLA.

MODERN VENDING COMPANY
286 N. W. 29th STREET
MIAMI, FLA.

SLOT PLAYERS HIT ENDLESS JACKPOT BUT UNCLE SAM SAYS JACK NO GOOD

SACRAMENTO, CAL.—Once upon a time, not so long ago, there were two guys who thought they had the system down pat to bring to continuous reality the slot player's dream of three little jackpot symbols sitting in a row.

And they did. For a while. And in that while they gave many California slot machine operators the howling trembles what with the havoc they were playing with the law of averages.

The two guys with the system are John J. Simpson, aged 42, and his 20-year old buddy, Grant Francis White. When last reported, they were sitting in the local jug explaining the system. It seems as though they made the slots shower down by the simple process of filling the machines with quarters they made themselves. And the law resents that.

Simpson and White denied that the lead was their but claim they won the wrong coin in the slots. In a newspaper interview, Simpson stoutly objected to the government's theory that he's a one man mint. In explaining himself to the news man, he said:

"I was just lucky that's all. We're stuck in Tracy one night last week, the kid and I, and I get to boozing it up a bit. The first thing I know I'm shoving two bit pieces into the slots. Then, bango, I hit the jackpot. Out comes eighteen or twenty dollars.

"Sounds good, but I look over the

take, and what have I got? Half the dough is phoney money. Those quarters are so phoney you couldn't pass them on a dim witted blind man.

"Now this peeves me no end. Anyhow, as we wander from bar to bar, I keep playing these machines, and everytime I win I get a lot of bad dough. Of course I'm sort of lucky — I hit three or four jackpots during the evening.

"But as we go along," Simpson continued, "I get more and more huffy about getting all these slugs. So finally I start putting them back in one of the machines and the proprietor gets sore and calls the law. Now we're charged with having bad money in our pockets and the federals think I'm the guy whose been doing this monkey business.

"They say I've been all around the state pulling this racket, but I haven't. I was just lucky — that's why they found about \$142 in good quarters on me in my car."

And that the federals did. But they also claim to have found 1200 lead quarters, coin molds and large chunks of lead in the car. And that's tough stuff to pass off as hay.

There's one more rub to the story. Simpson claims he lost money on the slots, jackpots notwithstanding. He said he started out with a bankroll of \$197. Subtracting the \$142 in good coin he was found with left a red balance of \$55.

BALTIMORE and AREA

EVERY OPERATOR INVITED TO A SHOWING OF

A ONE-BALL FREE PLAY GAME

DOUBLE FEATURE

With principles that can be applied to '41 Derby, Pimlico, Longacre, Thorobred, and others. It has every new feature, plus cabinet design.

Victory Sales Co.

1100 HARFORD AVE., BALTIMORE 2, Md.
JOHNNIE LA PORE
Now with JACK BERGER



NEW MASTER VENDERS

available for immediate delivery, write.

To buy or sell Coin Machines In Columbus, Ohio

SEE **G. N. VENDING COMPANY**

663 W. Broad St. Columbus 8, Ohio

20 years experience

MOTORS REPAIRED

WURLITZER - SEEBURG - ROCKOLA - MILLS - AMI
Rewound to Factory Specifications. Rapid service—
repaired or exchanged within 24 hours after arrival.
Complete
No Extras..... **\$7.00**

M. LUBER
503 W. 41st St. (LONgacre 3-5939) New York

ROWE WINS AWARD OF THE AMERICAN PUBLIC RELATIONS ASSN FOR THE YEAR

Will be Presented to R. Z. Greene by Secretary of Agriculture Anderson in Wash'gton, Sat., Mar. 30



ROBERT Z. GREENE

WASHINGTON, D. C. — Robert Z. Greene, president of Rowe Manufacturing Co., Belleville, N. J., was given the "Award Of The Year" by the American Public Relations Association in this city Saturday, March 30, 1946 for the booklet which the firm produced addressed to returning veterans and telling them all about the vending machine business. The presentation of this award was made by Secretary of Agriculture Anderson.

Greene has been intensely interested in public relations work for the merchandising machine division of the industry. As president of NAMA (National Automatic Merchandising Association) he has sponsored the first public relations program for the trade. His work in this direction is well known. His firm employs the noted public relations counselor, Win Nathanson, who has won many awards for his work in the public relations field.

It is believed thruout the industry that this is the first time that any coin machine firm has won the award of the year given by the American Public Relations Association and should mark an historical turning point for the field.

It presents great possibilities for other firms in the industry to also drive for greater public understanding of this coin operated machines business.

There is no doubt that by winning this award the Rowe Manufacturing Company, Inc. will reflect great credit on the field for its work in public relations. It is generally believed by the merchandise machine trade that greater efforts will be put forth by Rowe this forthcoming year in gaining the public's good will toward the vending machine business.

EVERYBODY TOGETHER!

Chicago Premiere

OF THE NEW

AMI PHONOGRAPH

**ALL OPERATORS! ALL DISTRIBUTORS!
ALL MANUFACTURERS! EVERYBODY WELCOME!**

Hotel Continental

505 NORTH MICHIGAN AVENUE

APRIL 10 & 11, 1946 • 10 A.M. TO 10 P.M.

A SENSATIONAL SHOW!

A GOOD OLD-FASHIONED GET TOGETHER!

We don't want THOUSANDS of games — but we'll pay **TOP DOLLAR**

For equipment you care to sell

State **KIND-QUANTITY CONDITION and PRICE** in your first letter.

AMMCO Distributors

2513 MILWAUKEE AVE. — CHICAGO 47, ILL.

PHONE: CAPITOL 1111



COIN CHANGERS GET OPS ATTENT'N

CHICAGO — Coin changers are gaining the attention of the operators, jobbers and distributors throughout the industry, according to reports released here by leading coinmen.

Since the trade read the first item relative to coin changers in the Saturday Evening Post there has been greater interest shown in these than ever before.

The general belief here is that these will not only please location owners but will make for more efficient and modern merchandising of a storekeeper's products by eliminating the time wasted to make change for phone calls and purchases of an unprofitable nature.

As far as the operator is concerned, coinmen here state, coin changers will help them to earn more money from their equipment in the location for they eliminate the necessity for the user of a machine from going up to the storekeeper to obtain change.

Since change will be more easily available it will mean speedier action on all types of coin operated machines in the location.

"Coin changers will prove great necessities for the operators", one distributor here said, "because they will bring in more profit and that means more rapid amortization of equipment. They will, therefore, pay for themselves in a hurry".

At the present time there is a demand for coin changer machines from vending machine operators who now claim that these are necessary to the profitable continuance of their business. Installations of these in conjunction with beverage venders has already been proved profitable for this type of equipment.

It is also believed here that operators will be using coin changers in conjunction with all types of equipment.

Storekeepers will be demanding these, they say, as they grow more popular. Publicity already released on coin changers is reported to have already brought a great many inquiries.

It is also reported here that coin changers will soon be shown to dis-

tribute and jobbers and that before many months have passed there will be a goodly number of these for the trade.

In the meantime coinmen look forward to announcements of new coin changers.

ARCADE EQUIPMENT — LIKE NEW

Exhibit Post Card Machines.....	\$ 19.50	Seeburg Chicken Sam	\$109.50
View Machines	19.50	Bally Rapid Fire	119.50
Evans Ten Strike	49.50	Western Baseball, Late	119.50
Keeney Texas Leaguer	49.50	Keeney Submarine	129.50
Texas Ranger	52.50	Scientific Batting Practice.....	129.50
Gottlieb Skee-ballete	59.50	Williams Periscope	149.50
Exhibit Punching Bag	59.50	Keeney Air Raider	149.50
Scientific Upright Basketball	59.50	Shoot Your Way to Tokyo.....	159.50
Radio Rifles	59.50	Bally Submarine	179.50
Exhibit Foot Ease Vitalizer	69.50	Supreme Rocket Buster	209.50
Love Meters, Per Set of 3.....	75.00	Thunderbolt	225.00
Chicken Sam Converted to Hitler Gun..	79.50	Mutoscope Sky Fighter	229.50
Rock-Ola World Series	99.50	Super Skeeroll (Like New)	269.50
Kirk-Blow-Ball	99.50	Mutoscope Drivemobile.....	279.50
Chicken Sam Converted to Jap Gun.....	99.50	Chicago Coin Goalee, Like New.....	Write

PINS

A B C Bowler	\$ 65.00	Progress	27.50
Stratoliner	49.00	Sport Parade	57.50
Landslide	42.50	Baker's Defense	35.00
Lucky	20.00	Red, White and Blue	29.50
Cadillac	30.00	Big Chief	59.50

NOW DELIVERING NEW EQUIPMENT

Bank Ball 9' Size	\$375.00	Gottlieb's Stage Door Canteen.....	249.50
Bank Ball 12' Size.....	445.00	William's Suspense	279.50
Bank Ball 14' Size	495.00	Bally's Surf Queen	289.50
		Bubbles, Pioneer new revamp.....	249.50

DAVE ENGELS

IRV ORENSTEIN

HERCULES SALES & DIST. CO.

"A NAME YOU CAN TRUST"

415 FRELINGHUYSEN AVE., NEWARK 5, N. J.

PHONE: BIGELOW 8-3524 — CABLE HERDISCO

WANT 500 GAMES

CAN USE 500 FREE PLAY GAMES

(Parts must be complete)

SPORTY — PARADISE — JOLLY —
SCHOOL DAYS — POLO — HORO-
SCOPE — CHAMP — MIAMI BEACH
— SEA HAWK — MAJORS '41 —
SNAPPY '41 — STRATOLINER — SPORT
PARADE — SHOW BOAT — SEVEN UP
— SPOT POOL — ARGENTINE —
LITA CARD

Send Your List Stating Quantity,
Price and Condition.

MID-STATE CO.

2850 W. ROOSEVELT RD. CHICAGO 12, ILL.
TELEPHONE: SACRAMENTO 2671



if you think this is something

BIG...

wait 'til you see the new

JENNINGS

FIFTY-CENT

SILVER

EAGLE

RUNYON'S AMI SHOWING DRAWS BIG CROWD

NEW YORK — With over 800 coinmen in attendance, Runyon Sales Company premiered the new AMI phono "Model A" this past Wednesday, March 27, and reports that the acclaim and praise reverberated throughout the east. Coinmen from all sections of New York state, New Jersey and Connecticut attended the showing.

"In addition", Jack Mitnick of the firm reported, "over 600 were present on Thursday and about that many on Friday." He added, "Our show is still going on and will continue until April 5."

Barney (Shugy) Sugerman, Abe Green, Mike Munves, Dave Rosen and many AMI executives who attended this eastern premiere claimed, "Without any doubt this was the greatest showing of any automatic phonograph in all eastern music history."

At this meeting Barney (Shugy) Sugerman of Runyon Sales Company is reported to have stated, "We promised to show every music operator the best machine of all time. We're not only going to do that, but, we are going to show him the 'No. 1' machine of the automatic music industry."



The new AMI "Model A"



Top pic shows Runyon's executives, sales force, distributors and AMI executives at special breakfast in the East Room of the Hotel New Yorker a few hours prior to the grand opening. At the speaker's table, left to right: Abe Green, Bernie Wolfson, John Haddock, Jack Mitnick, Barney Sugerman, Dave Rosen and Herman Perin. Lower tables, left to right: Joe Munves, Harry and Sam Wichansky, Lindy Force, James Hyde, Monte West, Max Retting, Perry Lowengrub, Irving Kempner, Bill Hanlon, Mike Munves, Dave Weiss, Al Silverman, Joe Wasserman and Sid Meyers.

Center Pic shows Runyon executives conferring with AMI's president, John Haddock, left to right: Mike Munves, Abe Green, John Haddock and Barney Sugerman.

Lower pic shows some of the crowd that came to the premiere showing.

Now Delivering — Keeney's Sensational

LIMITED QUANTITIES

BONUS SUPER BELL

FIVE COINT MULTIPLE — CONVERTIBLE FP or PO

COME IN AND SEE IT OR WRITE FOR INFORMATION

EXCLUSIVE DISTRIBUTORS IN NEW ENGLAND

TRIMOUNT COIN MACHINE COMPANY

40 WALTHAM STREET

BOSTON 18, MASS.

(Tel. LIBerty 9480)



"There is No Substitute for Quality"...

STAGE DOOR CANTEEN

**PROVES IT
WITH PROFITS!**

ORDER FROM YOUR DISTRIBUTOR NOW

D. GOTTLIEB & CO.

"First with the Finest"

1140 N. KOSTNER AVE.
CHICAGO 51, ILLINOIS



• JOIN **CMI** NOW •

STRAHL TO GIVE BIG BANQUET

PITTSBURGH, PA. — Sam Strahl of American Coin-A-Matic Machine Co., this city, reports that he will give one of the biggest banquets in the history of this city on Sunday evening, March 14 to show the new AMI "Model A" automatic phono.

He reported, "The banquet will start promptly at 6:30 P.M. There will not be any prior showing of the new AMI 'Model A' phono. The dinner will be in the Pittsburgher Room of the Wm. Penn Hotel and we expect to have over 800 diners.

"The floor show, which will be one of the most elaborate in Pittsburgh's history will start at 7:30 P.M. There will be a big chorus line. There will be present some of the most famous stage, screen and radio stars and every recording star who is playing within 100 miles of this city.

"As the floor show comes to an end at about 9:30 P.M.—the new AMI 'Model A' will be unveiled right on the stage. From then on everyone attending the banquet can come right up on the stage and inspect the machine. We will invite all present to see the inside as well as the beautiful outside construction of the new AMI phono."

Strahl also said, "After this Sunday evening the 'Model A' will be on display at our showrooms and all those who want to see it and give it a close examination will be sincerely invited to do so. We shall at that time also arrange for receiving orders and taking care of deliveries."

PARKING PROBLEMS BOOM PARKING METERS

NEW YORK — Everywhere in the nation the parking meter is now booming as one of the great favorites of all municipalities due to the terrific parking problems which have resulted since the end of gas and tire rationing.

Indianapolis, Ind. has gone thru one of the longest and most drawn out arguments relative to the installation of parking meters and now the city council has chosen the "Park-O-Meter" machine for its downtown streets.

Binghamton, N. Y. citizens were notified on March 13 that the following morning they would have to start inserting pennies and nickels into meters to get their cars parked in their downtown streets.

Englewood, N. J. told its citizens that meters were on the way in and the city fathers here believe this will help solve their parking problems.

Ocean City, N. J. papers are publishing letters from the public for and against parking meters.

In the meantime parking meter firms are deluged with orders for more of these units than they ever before enjoyed. They believe that this will continue to grow even greater as the weeks go by and more communities thruout the nation realize that the one and only way to



"LOOK
FOR THE EAGLE...
YOU'LL FIND
THE BEST!"

REPLACEMENT PLASTICS

for all makes and models of
AUTOMATIC PHONOGRAPHS

(the oldest and newest)

NOW AVAILABLE
RIGHT PRICES

SEND FOR
COMPLETE
PRICE LIST

EAGLE

COIN MACHINE CO.

1514 N. FREMONT AVE.

MICHIGAN 1247

CHICAGO 22, ILL.

prevent their downtown shopping streets from becoming completely jammed with autos is to confine parking to certain rules and regulations

(And, once again, the coin machine operators do not profit from a coin machine.)

STAGE SEAT CANTON



— 100 —

MADE IN
ENGLAND

WALTER
SIMPSON & CO.

10, BUTTICE & CO. LTD.

10, BUTTICE & CO. LTD.
LONDON, E.C. 4

THESE ARE THE SEAT

FOR THE STAGE
AND THE THEATRE



MUSIC OP CALLS FOR BUREAU OF STANDARDS TO TEST SUPPLIES

NEW YORK — Fred Salerno, head of the Roxy Automatic Music Company, music operators here, this past week urged that the industry establish a "bureau of standards" for phono supplies, which would put a warranty on the claims of manufacturers and thus benefit the trade.

"I for one am very tired of being taken in by the claims made for new products," Salerno told *The Cash Box*. "I'm also tired of reading how some new phono record will spin for hundreds of plays or how some needle will serve thousands of times when, in practise, they perform about ten percent of the claims they make.

"This is going to be an expensive year for all of us as it is, and it isn't helping the situation any to lay money on the line for products that will cause this money to go down the drain.

"I know that reputable manufacturers have no fear of putting their products to an impartial test, but today, when everything produced can be sold, everyone with a bankroll seems to be getting out a product; they slap a lot of performance claims on it, they advertise it, we buy it and then come the lemons.

"This industry is growing. It's rising in importance and reputation every day. It can go on full steam ahead and enjoy even greater confidence and a finer reputation by the creation of a 'bureau of standards.'

"Breakdowns and imperfect reception antagonize our customers. The results are smaller collections.

"As music operators, we and our equipment, represent the industry to the location owner and to the public. It's our job to stand behind that equipment and to deliver the best in music. When we do that, we're doing our job well.

"We want to give the best, but we can only do that when we have the best to give. We want to stop buying blind.

"If a 'bureau of standards' for phono supplies were established which could impartially test and approve or disapprove supplies, we could prove that we are offering the best.



WANTED: 66,000,000 WEARERS—The Red Cross hopes that, by March 31, 66,000,000 Americans will be wearing this lapel tab, symbol of a generous heart. How about it?

Scranton Records Sold to Capitol

SCRANTON, PA. — Capitol Records, Inc., Hollywood, Cal., has announced the purchase of all stock of the Scranton Record Company, this city, which operates a plant here employing 700 persons.

**THIS OFFER GOOD FOR 30 DAYS
WILL PAY FOR FOLLOWING IN
GOOD CONDITION**

\$385.00 for 600 Keyboard
\$575.00 for Model 700 Wurlitzer
\$665.00 for Model 800 Wurlitzer

**WRITE FOR PRICES ON ALL
OTHER EQUIPMENT**

We Pay Freight Within 500 Miles

AMERICAN COIN MACHINE CO.
437 Elizabeth Ave. Newark 8, N. J.
Phone: WAverly 3-1500

SCIENTIFIC'S ORIGINAL X-RAY POKER LIMITED QUANTITIES — ACT FAST DISTRIBUTED BY

Joe Ash
in Pennsylvania

OR

Irv Morris
in New Jersey

ACTIVE AMUSEMENT MACHINES COMPANY

900 N. FRANKLIN STREET
417 FRELINGHUYSEN AVE.

PHILA. 23, PA.
NEWARK 5, N. J.

MARKET 2656
BIGELOW 8-1195

"YOU CAN ALWAYS DEPEND ON ACTIVE — ALL WAYS"

GUARANTEED TO SATISFY or YOUR MONEY BACK! NEW RELEASES — NOW DELIVERING!

SUSPENSE	\$279.50	EVANS BANGTAILS,	
CATALINA	249.50	P. O., D. D., J. P., 7-COIN HEAD	\$596.50
MILLS' VEST POCKETS, 5c.....	74.50		
RIVIERA	279.50	SMILEY	39.50

ONE-BALLS			
Blue Grass, F.P.....	\$185.00	Jockey Club	\$325.00
Club Trophy, F.P.....	285.00	Kentucky	205.00
'41 Derby, F.P.....	295.00	Long Acre	410.00
Fairmount	475.00	Pimlico, F.P.....	325.00

ARCADE EQUIPMENT			
Bally King Pin.....	\$195.00	Keeney Sub Gun.....	\$145.00
Bally Rapid Fire.....	145.00	Mutoscope Photomatic.....	500.00
Bank Ball, New.....	375.00	Mutoscope Sky Fighter.....	245.00
ChicoIn Goalee, New.....	525.00	Pilot Trainer, New.....	850.00
ChicoIn Hockey.....	205.00	Scientific Batting Prac.....	125.00
Evans Play Ball.....	155.00	Seeburg Chicken Sam.....	110.00
Evans Ten Strike, HD.....	75.00	Western Baseball, '39.....	95.00
Genco Total Roll, New.....	525.00	Wurlitzer Skeeball	235.00
Keeney Air Raider.....	165.00		

CONSOLES			
Four-Way Super Bell.....	\$485.00	Paces, Saratoga, No	
High Hand	195.00	Rails	\$ 75.00
Jumbo Parade, F.P.....	115.00	Paces Saratoga, Jr., P.O.	75.00
Jumbo Parade, P.O.	125.00	Paces Reels, Sr., P.O.....	125.00
Mills 4 Bells	450.00	Paces Twin, 5-10.....	245.00
Paces Saratoga, w. Rails	95.00	Silver Moon, F.P.....	125.00
		Super Bell, 5c Comb.....	295.00

IF ANY MACHINE DOES NOT MEET WITH YOUR COMPLETE SATISFACTION RETURN IT WITHIN FIVE DAYS AND WE WILL PAY THE FREIGHT BOTH WAYS.

WRITE FOR COMPLETE LIST Terms: 1/3 Deposit, Balance C.O.D.
BELL PRODUCTS CO.
2000 N. Oakley CHICAGO, ILL. 1085 Monadnock Bldg. 'CALIF. 'SAN FRANCISCO

**MILLS
PANORAM REELS**

\$36.00 Per Wheel of Six Subjects. Series 1 to 18 now available. Don't delay. Order now for immediate delivery. Catalog on request.

**"PERFECT-POINT"
PHONO NEEDLES**

In Lots of 100—
39c EACH

OPERATORS IN THE STATE OF GEORGIA

COME IN AND SEE

ROCK-OLA The PHONOGRAPH OF TOMORROW

NOW ON DISPLAY

MULLINIX AMUSEMENT CO.

1514 - 16 BULL ST.

SAVANNAH, GA.

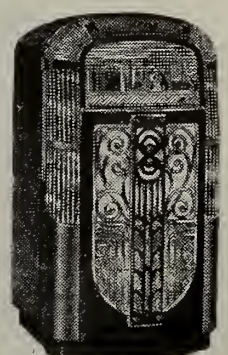

MUSIC OF CALIF
FOR BUREAU OF
STANDARD TO
TEST SUPPLIES

STANDARD TO
TEST SUPPLIES

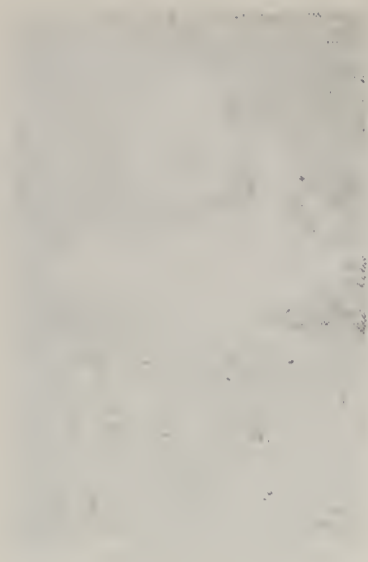

STANDARD TO
TEST SUPPLIES

STANDARD TO
TEST SUPPLIES



OPERATORS IN THE STATE OF ARIZONA

COME IN AND SEE

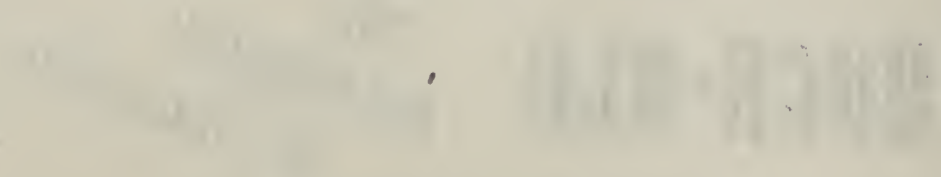

HOW TO ORDER

VALLEYVIEW EQUIPMENT CO

1000 N. 10th St.

SIROS OPENING NAT'L DISTRIBUTING OFFICES IN CHI

HOUSTON, TEX. — W. V. (Bill) Siros, president of Amusement Enterprises, this city, who recently announced that he was given the green lite to go ahead with a huge expansion program for his firm, stated this past week that negotiations had just been completed for the opening of national distribution offices for the firm in Chicago.

"We expect", Siros reported, "to have our Chicago offices and showrooms operating just as soon as we can find suitable space. From these offices and showrooms the products manufactured by Amusement Enterprises as well as the products of leading manufacturers will be handled on an exclusive basis. Our Chicago staff will include some of the leading figures in the coin machine business."

Siros also stated that large crews of workmen have been speeding the enlargement of the factory and general offices of the firm here. Orders for a pinball machine and a bowling game called, "Bowl-A-Ball", have been pouring in, Siros claims.

He also said, "The entire working staff of our factory will be augmented from time to time to meet the influx of orders."

Siros stated, "Production of 'Pitch 'em', one of our hottest games, will be first off the assembly line. Immediately following this machine will come the original counter model Dice Shaker. Delivery of these two items", Siros continued, "will be made to appointed distributors in two weeks."

SLOT HOBBYIST FINED

BOISE, IDA. — Regardless of the fact that Frank W. Matthews claimed the two slots he had in his office at the Rosana Shop here were old machines which did not work and that he repaired them as a hobby, Judge J. M. Lampert fined him \$200 of which \$175 was suspended. Matthews also stated that the machines had never been used by anyone but himself.

The only thing that Frank seemed to forget was that slots require a license in this state. So hobby or no hobby Frank will either have to buy licenses or get rid of his hobby.

LAZARS TO SHOW NEW ROCK-OLA IN ERIE, PA.

PITTSBURGH, PA. — B. D. (Ben) Lazar and J. D. (Si) Lazar of the B. D. Lazar Company, this city, announced this past week that they will show the new Rockola "Phonograph of Tomorrow" (Model No. 1422) at the Ford Hotel in Erie, Pa. on April 6 and 7th.

According to Si, "This is the first time that we have been able to remove the new Rockola phono from our showrooms here so that the juke box operators of northwestern Pennsylvania will have the opportunity of seeing and hearing it for themselves.

"We have had a very large number of phone calls, letters and wires", Lazar continued, "from music machine operators in Erie and surrounding territory and they asked us to bring the machine up to the Ford Hotel for a special showing."

Both Lazar Brothers also reported that invitations have already gone forth to everyone of the juke box ops in northwestern Pennsylvania to advise them of this showing and that many have replied they will be in town waiting for the arrival of the new Rockola phono.

NO CIG VENDERS IN ZION

ZION CITY, ILL. — Tho the city council has eased the blue laws there will be no ciggy venders here in view of the fact that persons under 18 are not allowed to smoke and the council believed cig machines would circumvent this ruling.

Tubular COIN WRAPPERS

•

1 Case65c per M
3 Cases.....60c per M
6 Cases.....53c per M

Less Than Case Lots. Assorted Denominations. 70c per M.
50c PENNIES19 M to CASE
\$2.00 NICKELS17 M to CASE
\$5.00 DIMES20 M to CASE
\$10.00 QUARTERS15 M to CASE
\$10.00 HALVES15 M to CASE

Case lots shipped. One denomination to case. Order in quantity conforming to packing if possible.

1/3 Deposit with Order, Bal. C.O.D.

CHARLES (JIMMY) JOHNSON
GLOBE DISTRIBUTING CO.
1623 N. California Ave. Chicago 47
(Phone: ARMITAGE 0780)

NEW RELEASES UNITED — FOR BETTER BUYS NOW DELIVERING

Evans Ten Strike Evans Custom Consoles Bally Surf Queens	Bally Undersea Raider Chicago Coin Goalee Bally Victory Derby	Amusematic Lite League Genco Total Roll Bally Victory Special
----------------------------------------------------------------	---------------------------------------------------------------------	---------------------------------------------------------------------

— PACKARD BOXES, SPEAKERS, AUXILIARY EQUIPMENT —
ALSO THESE RECONDITIONED BUYS IN USED MACHINES SLOTS

MILLS BLUE FRONTS COMPLETELY REFINISHED LIKE NEW WITH CLUB HANDLES 5c PLAY.....\$129.50 10c PLAY.....139.50 25c PLAY.....189.50	NEW BLACK CHERRY BELLS 5c - 10c - 25c PLAY.....WRITE 5c Melon Bell.....\$125.00 5c Brown Front.....140.00 10c Brown Front.....175.00	5c Cherry Bell.....140.00 5c Brown Front, Rbt...125.00 5c Chrome 2/5.....195.00 5c Futurity.....\$125.00 5c Silver Moon Chf....125.00 5c Jennings Chief.....125.00 10c Caille 3/5.....60.00 10c All Star.....65.00 10c Watling.....75.00 DOLLAR JENNINGS CHIEFS, Refinished Like New\$695.00
----------------------------------------------------------------------------------------------------------------------------------------------------	---------------------------------------------------------------------------------------------------------------------------------------------------------	-------------------------------------------------------------------------------------------------------------------------------------------------------------------------------------------------------------------------------------------------------------------------------------------------------------------------------

ARCADE EQUIPMENT

Bowl A Ball\$195.00 Bowl A Bomb.....175.00 Drivemobile250.00 Pacific Express, A-1225.00	Rapid Fire\$125.00 Tommy Gun130.00 Air Raider175.00 Zingo125.00	Skyfighter\$200.00 Bank A Ball195.00 Bowling League175.00 Lucky Strike125.00
--------------------------------------------------------------------------------------------------------------------	--------------------------------------------------------------------------------------------------	---------------------------------------------------------------------------------------------------------------

PHONOS — SPECIALS

Capehart 20 selector Phono.....\$120.00 Santa Anita 1-Ball P.O.....110.00 Single Box Stands12.50 Buckley Track Odds, D.D.475.00 Evans Lucky Lucre '41195.00	Jumbo Parade, P.O.\$ 89.50 Singing Towers — 40 Selector450.00 Race King — 1-Ball P.O.125.00 Packard Boxes — Used, A-129.50 Five Balls — Write for list.
------------------------------------------------------------------------------------------------------------------------------------------------------------------------------------------	-------------------------------------------------------------------------------------------------------------------------------------------------------------------------------------------

Want — Phonos — 5-Balls — All Models — Genco Playballs — Evans Ten Strikes
TERMS: 1/3 CERTIFIED DEPOSIT

UNITED COIN MACHINE COMPANY
"WISCONSIN'S LEADING DISTRIBUTOR"
6304 WEST GREENFIELD AVE. (PHONE: GREENFIELD 6772) MILWAUKEE 14, WIS.

OPERATORS!! HERE ARE 2 PROVEN WINNERS OF 1946

- 1. GOTTLIEB'S STAGE DOOR CANTEN**
 THE GAME THAT EVERY OPERATOR AND LOCATION WANTS
- 2. THE ROCK-OLA PHONOGRAPH OF 1946**
 THE PHONOGRAPH THAT IS THE LAST WORD IN MUSIC TODAY

WE HAVE THEM BOTH!

COME IN AND SEE THEM — AND PLACE YOUR ORDER

B. D. LAZAR COMPANY

1635 FIFTH AVENUE (ALL PHONES: GRant 7818) PITTSBURGH, PENNA.

DELETED IN ALL NEW YORK
 STATE ARCHIVES
 NEW YORK
 STATE ARCHIVES
 DELETED IN ALL NEW YORK
 STATE ARCHIVES

DELETED IN ALL NEW YORK
 STATE ARCHIVES
 NEW YORK
 STATE ARCHIVES
 DELETED IN ALL NEW YORK
 STATE ARCHIVES

DELETED IN ALL NEW YORK
 STATE ARCHIVES
 NEW YORK
 STATE ARCHIVES
 DELETED IN ALL NEW YORK
 STATE ARCHIVES

DELETED IN ALL NEW YORK STATE ARCHIVES

DELETED IN ALL NEW YORK
 STATE ARCHIVES
 NEW YORK
 STATE ARCHIVES
 DELETED IN ALL NEW YORK
 STATE ARCHIVES

ROBINSON AGAINST LOCATIONS KNOWING PRICES

WASHINGTON, D. C. — Jack Robinson, vice-president of the Washington Coin Machine Assn., this city, wrote the following letter to *The Cash Box* this past week.

"Your editorials in your March 11 issue are all well and good, but, you have overlooked the most important thing of all.

"The — magazine gives anyone that has a quarter all the secrets of the coin machine business. For instance, the other day while checking a spot which I have had for years, a stranger asked me what the machine cost. While I was stalling, thinking of an answer to give him, my customer said—the machine costs so much. He had seen the price in — magazine.

"I hope that the manufacturers never, never make a mechanically perfect machine. It's the only thing that is stopping lots and lots of locations from buying their own equipment. They can't repair the machines.

"Manufacturers and distribs who advertise their products openly are very shortsighted. My very close friend, J. Koenig, owner of a tavern, was sold a music box in 1936. He still owns and operates this same music machine. It gives him lots of trouble and he is never up-to-date as far as records are concerned, yet he tells me that as far as the juke box is concerned all the money belongs to him. (I operate amusement machines in his place.) No one has a chance of selling him on a new juke box. But, if an operator had this location he would long ago have pulled out this obsolete box and replaced it with a current machine.

"As an operator all I can ask is for the manufacturers to stop and think before they again decide to openly advertise their products and prices where every storekeeper can see them."

Jacobs To Have Surprise

MILWAUKEE, WIS. — Harry Jacobs, Jr. of United Coin Machine Co., this city, reports that he will soon have a surprise announcement for the trade which he believes will attract a great many operators to the firm's showrooms and offices here.

"We aren't ready yet", Jacobs stated, "but within a few more weeks we hope to be able to make an announcement which will prove of real value to all the operators in our territory."

PARTS — SUPPLIES PHONO TITLE STRIPS

55c PER 100

WRITE FOR QUANTITY PRICES

ROCK-OLA CRYSTAL

Pick-Ups, B-2 Cartridge, \$3.00 ea.

ECONOMY SUPPLY CO.

615 TENTH AVENUE, NEW YORK, N. Y.

(Phone: BRyant 9-3295)

SLOT BARGAINS

MILLS ORIGINALS

1— 5c Roman Head 3/5 Ref.....	\$ 95.00
1— 5c Gooseneck 2/4	40.00
1— 5c Mint Vendor 3/5	85.00
8— 5c Blue Front 3/5	125.00
1—10c Blue Front Ch	165.00
3—25c Blue Front KA CH 3/5.....	225.00
11—5c Brown Front 3/5 Cherry Bell.....	150.00
1—25c Brown Front KA CH 3/5.....	245.00
1—25c Brown Front Ref Gold CH 3/5.....	250.00
2— 5c Blue Front Ref Gold CH 3/5.....	160.00
1— 5c Melon Bell 3/5.....	150.00
2—5c Gold Chrome 2/5 Original.....	225.00
3 Double Cabinets 2 Door.....	60.00
1 Double Cabinet 1 Door.....	50.00

JENNINGS

1— 5c Gooseneck 2/4	\$ 35.00
1—25c Gooseneck 2/4	60.00
3— 5c Chief Fac Reb & Ref 2/5.....	140.00
1— 5c Mast Silver Chief S.P. 3/5.....	175.00
1—25c Mast Silver Chief S.P. 3/5.....	225.00
1—10c Silver Moon Chief	200.00
1—10c Chief Ref 3/5.....	125.00

MISCELLANEOUS

2— 1c Watling 2/4	\$ 30.00
2— 5c Caille 2/4	35.00
1—25c Pace Comet 3/5	150.00
1— 5c Pace Comet 3/5	60.00

P. O. GAMES

2 Longshots, P.O. \$150.00
TERMS: 1/3 Deposit with Orders. Balance C.O.D. or S.D.

MITCHELL NOVELTY CO.

1629 West Mitchell St. Milwaukee 4, Wisc.

WANT THE BEST? SEE MERCURY! 2 NEW MERCURY CONVERSIONS RAY GUNS

THEY'RE TERRIFIC — SENSATIONAL

SHOOT THE BARTENDER

CONVERTED FROM CHICKEN SAM

Entire Mechanism rebuilt from A-Z by mechanics that have spent years in the business. They not only LOOK but operate like new machines. Cabinets completely refinished and repainted.

ONE PRICE FOR EITHER MACHINE

\$155.00 F.O.B. CHICAGO

Send 1/3 Deposit

MAID 'N' MONSTER

CONVERTED FROM SHOOT THE CHUTES

SCENIC CONVERSIONS —

SAME MACHINES

Install them yourself in 20 minutes. Hand painted — colorful — greater player appeal.

New Low Price \$15.00 Each



6651 N. CLARK ST.
CHICAGO 26 ILL.

COIN MACHINE COMPANY

TELEPHONE
BRIARGATE 2516

★ Look To The GENERAL For LEADERSHIP ★

BIGGEST HITS IN THE INDUSTRY!

★ Exclusive Factory Distributors For These Leading Manufacturers: ★

- AIREON ELECTRONIC PHONOGRAPHS
- GOTTLIEB'S STAGE DOOR CANTEN
- JENNINGS BRONZE CHIEF and SUPER DELUXE CHIEF
- AMUSEMENT ENTERPRISES BANKBALL
- PFANSTIEHL'S COIN MACHINE NEEDLES — EAGLE PLASTICS
- EXHIBIT'S BIG HIT

COMING

GOTTLIEB'S
TRIPLE GRIP
TESTER

DAVAL'S
GUSHER

JENNINGS
CHALLENGER

Established 1925

Growing Steadily Ever Since



WANTED FREE PLAY CONSOLES

JUMBO PARADES, SILVER MOONS, BOBTAILS, SUN RAYS, LATE BIG GAMES, HI HANDS COMB. & BIG TOPS. ALSO ALL FREE PLAY FIVE BALL GAMES & MUSIC. SEND YOUR LIST!

EMPIRE
COIN MACHINE EXCHANGE
2512 W. NORTH AVE.
CHICAGO 47, ILL.
HUMBOLDT 6288-89

N. Y. AMUSE OPS MEET

Plan to Open City Presented. Over 125 Ops and Ex-Ops Attend

NEW YORK—Over 125 ops, many of them former amusement machine operators of this city, attended a meeting called by Joe Hirsch former president of the Amalgamated Amusement Machine Operators Association) and Bart Hartnett of the former Brooklyn Amusement Machine Association, at the Broadway Central Hotel (Thursday evening, March 28) to listen to plans which Joe Hirsch had worked on for some months and which he believed would be successful in re-opening this city to novelty amusement devices.

Seated on the rostrum and conducting this meeting were Joe Hirsch and Bart Hartnett with Jack Tashman (former secretary of the Brooklyn association) acting as secretary for the evening.

Hirsch read his plan to the assemblage from a prepared statement. It introduced the fact that Judge Rosenman's decision relative to novelty pin games (without the free play coils, meters, etc.) were not to be considered part of the Esquirol-Robinson Bill, Section 982 of the Penal Code. Hirsch's plan is quite simple and met with approval.

Hirsch then called on various people in the audience to give their viewpoints in this matter. Theodore M. Blatt, former attorney for the Brooklyn assn. gave a very revealing speech. Herman Brothers, attorney for the Arcade Owners Assn., also spoke on what would be required.

Other speakers included Mac Pearlman, former operator and jobber; George Ponsler and Irving Kaye of Amusement Enterprises Co. (Ponsler also revealed that he expected a favorable decision Friday, March 29, on his "Bank Ball" alley.) Bill Saphir, operator spoke on getting together. Sam Turk, former op also spoke as did A. Weill, R. Rosenberg and Marty Roth.

It was then decided to appoint a committee and this committee consists of: Joseph Hirsch, Lester Klein and Mike Wolpert for the New York City operators, with Jack Tashman, Ben Mintz, Arthur Malamed and Bart Hartnett for the Brooklyn operators.

What proved most interesting to all who attended this call to meet at the Broadway Central Hotel was the grand turnout of so many of the old time operators of this city. Everyone of these men stated that they would like to get back to again operating amusement machines.

The committee will now meet and make a complete study of its method of action and then will call a general meeting once again so that all can be present to hear what plans have been decided upon.



You're Invited

TO THE
PREMIER SHOWING
OF THE NEW

AMI

40 SELECTION PHONOGRAPH

WM. PENN HOTEL
PITTSBURGER ROOM
PITTSBURGH, PA.
SUNDAY, APRIL 14th

DINNER • 6:30
FLOOR SHOW • 7:30
PREMIER SHOWING • 9:30

AMERICAN COIN-A-MATIC MACHINE CO.

Exclusive Distributors in Western Pa., W. Va. and Va.

1435 FIFTH AVENUE

PHONE: ATLANTIC 0971

PITTSBURGH 19, PA.

WOLF'S AMI SHOW BRINGS COAST'S BIGGEST TURNOUT



CHET GARTON, MGR. M. S. WOLF DISTRIBUTING CO., SAN FRANCISCO LISTENING TO M. S. (BILL) WOLF EXPLAIN NEW AMI FEATURES

LOS ANGELES, CAL. — Bill Wolf of M. S. Wolf Distributing Co., this city, held the premiere showing of the new AMI phonograph, the "Model A", before what is now being considered one of the greatest crowds in all West Coast history. By early afternoon of Wednesday, March 27, there were reported to be over 700 operators present — many from as far away as Mexico.

DeWitt (Doc) Eaton, General Salesmanager of Automatic Instrument Co., Chicago, came to attend this premiere showing as did James T. Mangan, AMI's Public Relations Director and Paul Bleck, General Service Manager.

Among the hosts and hostesses for this affair were: Golden Williams and Al. Griebahn of Los Angeles offices; Bill Smith of the San Diego offices of the firm; Chet Garton of the San Francisco offices; A. M. Moss of Portland, Ore. and Bert Beutler, manager of the Seattle offices.

A continuous catered buffet lunch was served. Hams, turkeys, roasts of beef and a half of a steer were served. After these refreshments the ops who attended were enthralled by over 47 entertainers from sixteen recording companies. The visiting artists went all out to show their entertainment wares to the visiting music ops.

Among the tops stars who entertained were: Harry (The Gibster) Gibson, Mel Thorne and His Melotones and Louanne Hogan from Musicraft Records. Jimmy Wakely and the Andrews Sisters from Decca. Al Dexter, Gene Cooper, Spade Cooley and Dinah Shore from Columbia. Otis Rene from Excelsior. Joe Greene from G & G. Tex Achisne and His Santa Fe Boys, Eddie Dean, Monte Hale, Billy Austin and Alton Red from Victory Records. Freddy Martin, Dennis Day, Spike Jones, Tex Ritter, Lawrence Welk, Desi Arnaz, Roy Rogers from Victor. Buddy Rich, Ken Curtis, Deuce Spriggins

from Mercury. Andy Russell and the Dinning Sisters from Capitol. Teddy Walters and Phil Harris from Ara. Leone Rene, Herb Jeffries, Harry Brooks, Bob Heyworth from Exclusive Records. Jack Kenny from Spotlight. Austin McCoy, May Johnson, Jubilee Singers, Lillette Thomas and Chuck Slaughter from Sunshine.

Bill Wolf also revealed that he expected even a greater attendance at his San Francisco showing on April 3 and 4.

One of the most unique occurrences of the entire affair was the entire hour coast to coast telephone hook-up between John Haddock, President of the Automatic Instrument Co., who was attending a similar premiere showing at the New York City offices of the Runyon Sales Company and DeWitt (Doc) Eaton, General Salesmanager, from these Los Angeles offices.

The conversation was made public and those present were surprised to hear at the large number of orders taken in both places at the same time. It developed into a salesmanship contest between Bill Wolf and Barney (Shugy) Sugerman.

Juke box ops here claim that the most outstanding feature of the showing, next to the new AMI "Model A" phono and its surprising price, was the 3 and a half hour jam session which developed among the 47 recording artists who attended Wolf's premiere showing.

REAL BARGAINS!

Chico Hocky\$160.00 Pace Reels\$ 75.00
Skee Jump 50.00 Ex. Races 25.00

MUSIC

Wurlitzer P-12\$ 99.50
Wurlitzer 24 Buckley Cellar Job..... 285.00
Wurlitzer 24 Mechanism, as is..... 100.00
Wurlitzer Victory 24 385.00
Wurlitzer 950 A-1 725.00

ANY REASONABLE OFFER TAKES
2 Bally Grand National;
1 Western Dead Heat — 1-balls

JULES OLSHEIN & CO.
1100-02 Broadway Albany 4, N. Y.



HIT PARADE OF WESTERNS

LARRY WILLIAMS — and his "Cowhands"
Western songs with rhythm and pep to wake the slumbering souls.

#101-W
A' RIDIN' TOWARD THE SUNSET
LITTLE DARLIN'

#103-W
I CAN READ BETWEEN THE LINES
I'M LOST WITHOUT YOU MY LOVE

BUDDY WEBBER — and his "Stubble Jumpers"
Largest little Western Band in Hollywood.

#113-B
SLIP ME MY SLIPPERS SUSIE DARLIN
I'M A' RIDIN' THE RAILS

#115-B
I'M A' ROUNDIN' UP MY LOVE MY LOVE FOR YOU
FIDDLIN' DAN FROM OLD CHEYENNE

LOIS POWELL — and the "Stubble Jumpers"
That sweet and lovely voiced Western Gal we have waited so long for.

#117-P
IS IT WRONG
SOME MOTHER'S DARLIN'

#119-P
YIPPEE AYE
I WANT JUST ONE LITTLE DARLIN'

MELDON DALE — and the "Stubble Jumpers"
(THE MELANCHOLY COWBOY)
So easy on your ears, but pulls at your heart with his plaintive melodies.

#121-D
TONIGHT THE STARS ARE PLAYING PEEK-A-BOO
A NEW STAR IN HEAVEN TONIGHT

#123-D
WHEN THE MOUNTAINS KISS THE SKY
IN MY STABLE THERE'S AN EMPTY STALL.....
KEN PATTON — and the "Stubble Jumpers"
A soft home-spun voiced Western Lad direct from the Plains.

#129-K
THERE'S A DREAM RANCH IN THE SKY
GIVE ME AN OKLAHOMA GAL

#131-K
SILVER DEW ON THE BLUE GRASS TONIGHT
TRAIL TO SAN ANTONE

RUSS PIKE — and his "Prairie Knights"
Eighteen years on the radio and at last on records, a treat for his thousands of friends!

#133-R
I HAVEN'T GOT A NICKEL (OR A DIME)
ALONG THE NAVAJO TRAIL

#135-R
FORGIVE ME LITTLE DARLIN'
I WON'T HANG AROUND YOU ANY MORE

SCOTTY HARRELL
and HIS TEXANS

#157-H
I WONDER WHERE YOU ARE TONIGHT
I'M BUILDIN' A PALACE FOR ALICE
FROM DALLAS

#159-H
I'LL BLAME IT ON YOU
TOO BAD LITTLE GIRL, TOO BAD

ALL RECORDS RETAIL 55c

DEALERS REGULAR DISCOUNT
THIS IS YOUR ORDER BLANK
QUALITY AND QUANTITY GUARANTEED

TERRITORIES OPEN
DISTRIBUTORS WANTED

BERGER ENTERPRISE

Producers and Manufacturers of
Enterprise Records
8111 Santa Monica Blvd.
Hollywood 46, Calif.

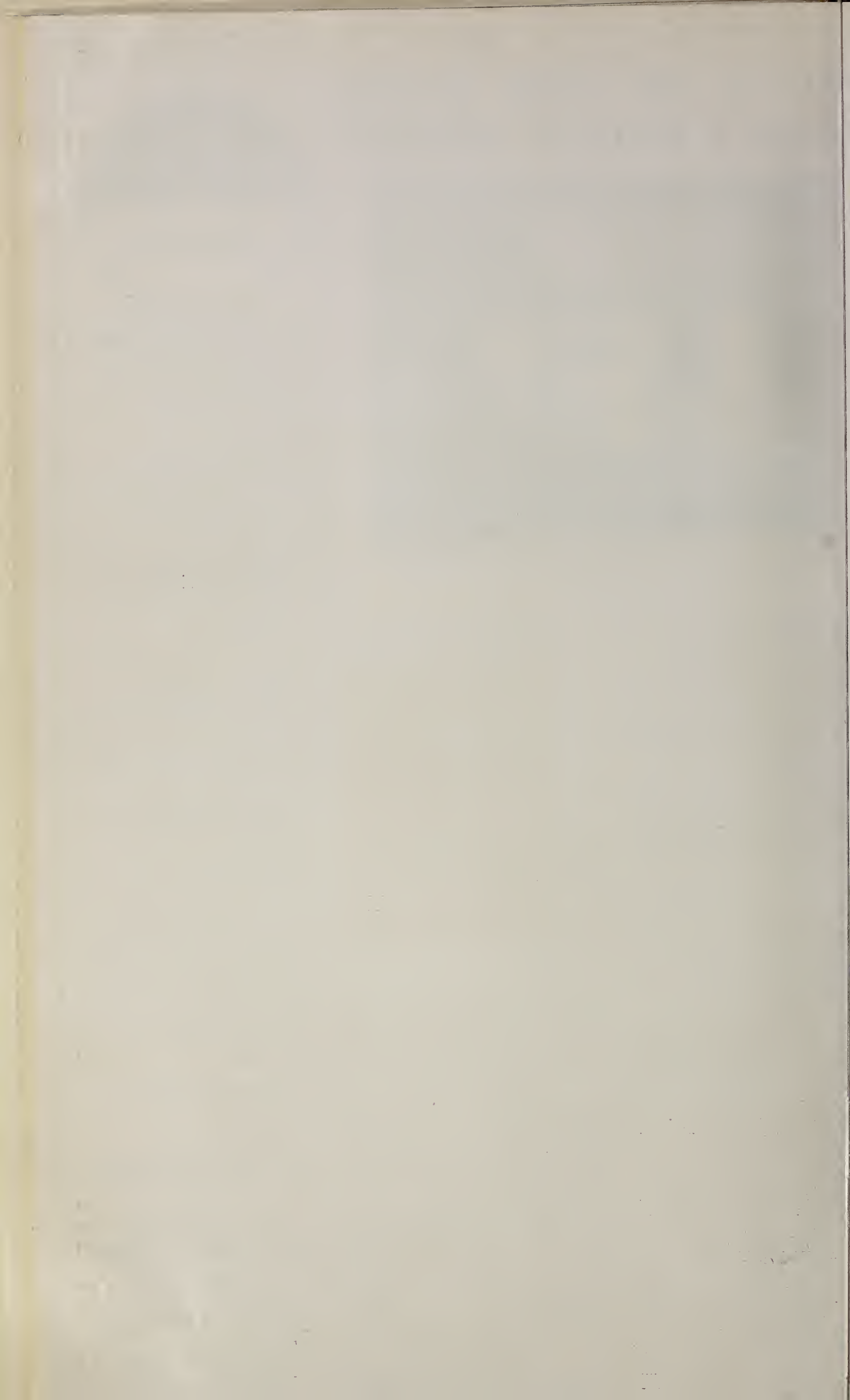

VINCE SHAY IS PRESIDENT OF NEW BELL-O-MATIC CORP.



VINCENT C. (VINCE) SHAY

CHICAGO — Vincent C. (Vince) Shay, one of the best known coinmen in the nation, was elected President of the newly formed Bell-O-Matic Corporation, exclusive national distributors for Mills bell products, this past week.

Vince is known to every operator who ever heard of this industry. His work with Mills Novelty Company for many years is well known to all in the trade. His wide knowledge of the coin machine business is second to none. In his new position as president of this new firm coinmen believe that he will prove of great value to the entire field.

Other officers of the firm are also well known to the entire industry. Executive Vice-President of Bell-O-Matic Corp. is the well known and well liked, A. V. (Art) Cooley. Treasurer of the firm is one of the best known coinmen none other than John P. (Midge) Ryan.

Other officers are: Ralph J. Mills, Vice-President, Herbert S. Mills, Vice-President, Hayden R. Mills, Vice-President E. E. Jacobson, Secretary and P. A. (Pat) Tennis, Assistant Treasurer. Grant Shay will act as Director of Advertising.

The firm will carry on the sale of all the bell products manufactured by Mills and will be in direct contact with everyone of the coinmen thru-



JOHN P. (MIDGE) RYAN

out the industry. Their deals will be entirely separate from any of those made by Mills Industries, Inc.

They are a complete and separate organization in their own right and make their own arrangements.

Vince Shay was being complimented all this past week by coinmen who flocked to his offices at 4100 Fullerton Avenue, this city, from all over the nation. The firm's offices remain in the large Mills building here.)

As one very noted coinman stated, "With a combination like Vince Shay, Art Cooley, Midge Ryan, Pat Tennis, Jacobson and Ralph, Herb and Hayden Mills, we just can't see how Bell-O-Matic Corporation can miss becoming one of the most outstanding organizations in the history of this business. If Vince Shay doesn't know the answer — then it just ain't known, brother."

Since this news broke many ops, it is reported, are planning to pay the new firm a visit and get acquainted with all the details.



A. V. (ART) COOLEY

It is also stated that a great many surprises are under way for the trade and that among these will be the presentation of some outstanding products the like of which have never before been seen in the field.

Officers of the firm are enthusiastic over this new incorporation and feel that they can now really break loose with some news which they have been saving for coinmen for sometime.

FOR SALE
200 BLUE AND GOLD
Refinished and Reconditioned
MILLS VEST POCKETS
 IN PERFECT CONDITION
 EACH \$45.00
BEAR SALES
 1351 W. Washington Blvd.
 Los Angeles 7, Calif.

JUKE BOX OPERATORS!

HERE IS OUR ANSWER TO YOUR REQUEST FOR QUALITY....

QUANTITY....

PRICE....

33c INCLUDES TAX

★ ★ ★ ★ ★ ★ ★

PAT KAY

URBAN #107

"Waiting For The Train To Come In"
 "I Seem To See My Louisiana"

URBAN #108

"Easy Street"
 "Love Me Not"

URBAN #109

"My Head Upon Your Shoulder"
 "Send Me A Man Amen"

HENRY RUSSEL

URBAN #112

"Pin Marin"
 (Peen Mareen)
 "How Can I Lose"

URBAN #113

"I Miss Those Little Things"
 "Adam Takes A Wife"

URBAN #118

"A Story Book Romance"
 "Since When"

URBAN #119

"Seems Like Old Times"
 "it's No Go"

ART WEST

AND THE SUNSET RIDERS

URBAN #110

"Where Is My Sombrero"
 "Tomorrow's In The Sky"

URBAN #111

"I Seem To See My Louisiana"
 "I'm Goin' Down The Mountain"

URBAN #116

"I Won't Tell On You"
 "She's Mine"

URBAN #117

"Yodeling Cow Girl"
 "You're A Part of My Heart"

THOMAS PELUSO

URBAN #114

"On The Beam With A Dream"
 "Feeling Zero"

URBAN #115

"I'm Just The Worrying Kind"
 "Pin Marin"
 (Peen Mareen)

VOCALS BY PAT KAY

★ ★ ★ ★ ★ ★ ★

WRITE — PHONE — WIRE FOR IMMEDIATE DELIVERY

★ ★ ★ ★ ★ ★ ★

SIERRA

DISTRIBUTING CO.

1506 N. SIERRA BONITA
 LOS ANGELES 46, CALIF.



**THE BIG THREE
MEETS
MUSIC OPERATORS
DEMAND FOR
MONEY MAKING
RECORDS**



JACK GUTSHALL



EXCLUSIVE

CONTACT YOUR NEAREST DISTRIBUTOR FOR
SIX NEW SENSATIONAL RELEASES

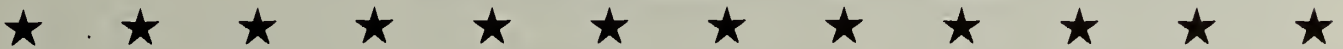

G & G

No. 1017

I'VE BEEN DOWN IN TEXAS
Coupled With
ROOT-LIE-VOOT

EFFIE SMITH

A Must On Every Automatic Phonograph

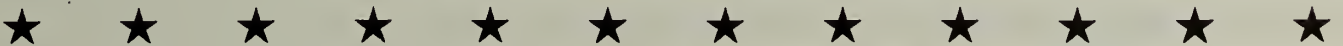

MODERN

No. 123

POLONAISE
POLONAISE BOOGIE

HADDA BROOKS

A Terrific Hit On West Coast — Let's Go East

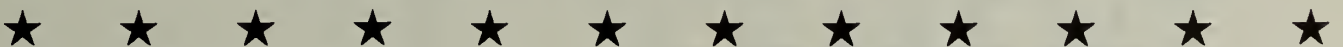

ORDER FROM YOUR NEAREST DISTRIBUTOR

A Newcomer To Our Family Of Distributors

LYON DISTRIBUTING CO., 726 S. 4th Street, Louisville, Ky.

Covers State of Kentucky and Southern Indiana

AMERICAN COIN-A-MATIC
1437 5th Avenue
Pittsburgh, Pa.

Covers Western Penn., Virginia, West Virginia

COMMERCIAL MUSIC
510 N. Sarah
St. Louis, Mo.

Covers St. Louis and Suburbs

RECORD SALES, INC.
2117 3rd Avenue North
Birmingham, Ala.

Covers Alabama and Georgia

MUSIC SALES
680 Union Avenue
Memphis, Tenn.

Covers Tenn. and Ark.

**STANDARD
MUSIC DISTRIBUTORS**
1913 Leeland
Houston, Texas

Covers Lone Star State

**PREMIER
AUTOMATIC MUSIC CO.**
640-42 South Street
Philadelphia 47, Pa.

Covers Eastern Penna.

MUSIC SALES
303 N. Peter Street
New Orleans, La.

Covers Louisiana and Mississippi

C & C DISTRIBUTING CO.
714 Fourth Avenue
Seattle, Wash.

Covers Oregon, Wash., Alaska, Montana, Idaho

ORIOLE DISTRIBUTING CO.
512 Pennsylvania Baltimore, Md

Covers Maryland, Washington, D.C., No. Carolina, So. Carolina, Florida

Territories Not Covered Above Still Available

JACK GUTSHALL DISTRIBUTING CO.
1870 W. WASHINGTON BLVD., LOS ANGELES 7, CAL.

HAPPEL'S ROCKOLA SHOW CLICKS



WM. R. (BILL) HAPPEL, JR., SURROUNDED BY HIS EFFICIENT STAFF

LOS ANGELES, CALIF. — Wm. R. (Bill) Happel, Jr. of Badger Sales Company, this city, is reported to have clicked with his showing of the new Rock-Ola "Phonograph of Tomorrow," Model No. 1422, to such an extent that the firm's orders for these new machines have set an all time high sales record.

Happel is reported to have said, "Never before in all our history in the coin machine business have we received such a large number of orders with deposits. This sets a new sales record for our firm which I doubt very much will ever be broken unless Rock-Ola can turn out even a greater machine than this one sometime in the future."

Happel also said, "Every music machine operator who called to see the new Rock-Ola told us that this was 'the greatest operators' machine of all time.' Not only that, but each one of these men believes that 'this is one machine that fits into every type of location.' And if that, in itself isn't sufficient praise then we just don't know what real praise is."

Happel continued, "From the moment the new Rock-Ola 'Phonograph of Tomorrow' was shown in our display rooms the crowds have been coming in to see the machine. Every operator who has called around and has seen this Model Number 1422 is tremendously impressed and especially pleased by the low price which Rockola set on this fine phonograph.

"We believe that we shall also set some real sales and delivery records thruout every part of our territory with the new Rock-Ola."

P & S FREE PLAYS ARE PROVEN WINNERS

Eagle Squadron
From — Big League

Shangrila

From — Mr. Chips

Torpedo Patrol

From — Formation

Paratroops

From — Powerhouse

Production

From — Blondie

Eagle Squadron

From — Big Town

→ KISMET

Our Latest

Bombardier ←

From — Follies

WANTED AT ONCE —

Punch, Tops, Formation and Powerhouse
See Your Distributor or Write To —

P & S MACHINE CO.

3017-19 N. Sheffield Ave., Chicago 14, Ill.

PHONO OPERATORS'
We Repair — Rebuilt and Recone all types
of Speakers.
PROMPT SERVICE — REASONABLE RATES
Out of State Jobs Solicited
DEE'S SERVICE SHOP
1119 Venice Blvd. Los Angeles 15, Calif.

**COIN MACHINE
MOVIES**
FOR REGULAR PANORAMS
AND SOLO-VUES
REELS OF 8 AND 6
SUBJECTS
Our Films Get The Dimes
PRICE \$37.50 TO \$38.50 Per Reel

NOTE: All of our Film for use in Panograms and Solo-Vues is specially treated and prepared to assure smooth running and maximum service.

DISTRIBUTORS FOR PHONOFILM
PRODUCTIONS AND QUALITY PICTURES
PHONOFILM
3331 North Knoll Drive
Hollywood 28, Calif.

**WATCH FOR GRAND OPENING
GOLD COAST COIN MACH. EX.**
LOS ANGELES, CALIF.
DISTRIBUTOR FOR
GOTTLIEB QUALITY PRODUCTS

AND IT'S ON
EXCELSIOR #174
**"CEMENT
MIXER"**
COUPLED WITH A NATURAL "SCINTILLATING BALLAD"
"I MUST FORGET ABOUT YOU"
BY
AL RUSSELL TRIO
ORDER NOW FROM
EXCELSIOR RECORD CO.
3661 S. GRAMERCY PL.
LOS ANGELES 7, CALIF.

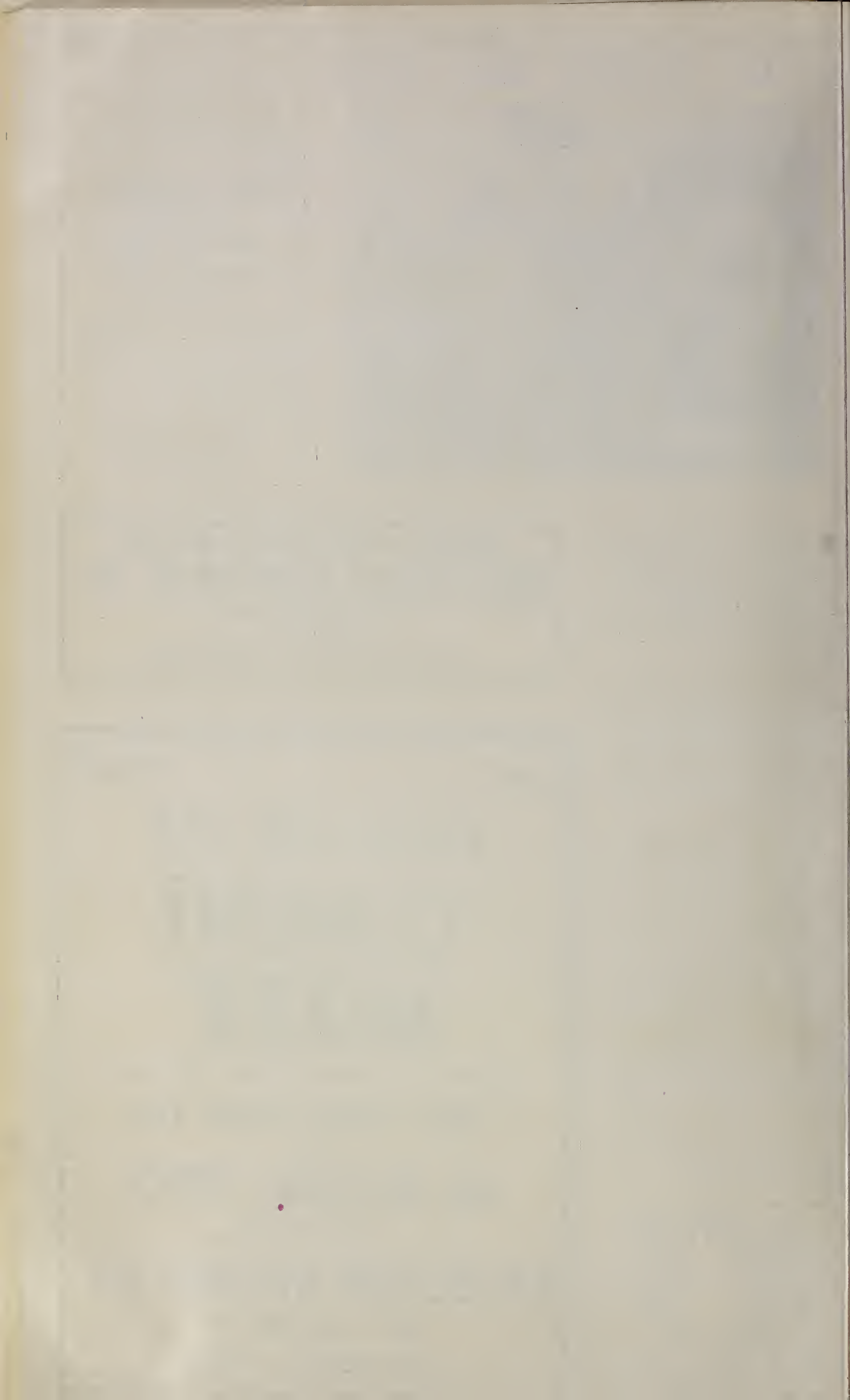

A amusement ENTERPRISES

90% LESS PARTS
HI-SCORE \$189.00

★ ★ ★ ★ STAR BELLS \$595.00

6-FT 12-FT BOWLING ALLEYS \$329.50 - \$379.00

1001-LOUISIANA-ST HOUSTON TEXAS.

MANUFACTURERS-NATIONAL DISTRIBUTORS

Coin-Machine-Equipment

NOW-APPOINTING DISTRIBUTORS

MAIN OFFICE OPENING IN Chicago Soon

PITCHEM COUNTER JENIATION \$137.50

JOINS PACKARD



T. M. WRIGHT

INDIANAPOLIS, IND. — Theodore M. Wright, formerly of the Rudolph Wurlitzer Company, has joined the staff of engineers at Packard manufacturing Corp., it is announced by Homer E. Capehart, chairman of the board of the Packard firm.

Mr. Wright has broad experience in the automatic music industry. He is recognized as a capable engineer and designer — and is also an inventor of some note. He was process engineer with Wurlitzer.

Phonographs - Wall Boxes

Rock-Ola Commando	\$630.00
Rock-Ola Imperial Hideaway.....	375.00
Rock-Ola Counter Boxes 5-10-25c.....	24.00
1943 Victory Model Seeburg.....	525.00
Wurlitzer 616	265.00
Wurlitzer No. 320 Model Boxes	17.50
AMI Singing Tower	375.00
Buckley 20 Record Counter Box.....	23.50

GAMES

Bally Thorobred	\$370.00
Bally '41 Derby	225.00
Keep 'Em Flying (5 Ball)	90.00
'41 Majors (5 Ball)	60.00
Do Re Mi (5 Ball)	65.00
2 Exhibit Rotaries, Each.....	200.00
Metro (5 Ball)	55.00

W. H. LEUENHAGEN & CO.
1813 W. PICO BLVD.
LOS ANGELES, CALIF. (Tel.: DR 1345)

TERRIFIC! SENSATIONAL!

TRIPLE CASH BOX RECEIPTS
Let Us Convert Your Hockeys From Single Play to SINGLE AND DOUBLE PLAY

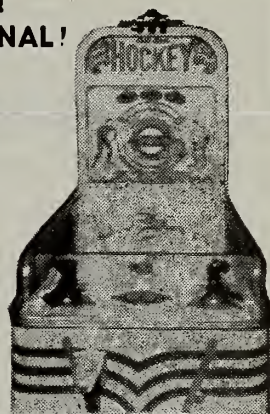

HOCKEY
ONLY \$69.50
WRITE — WIRE PHONE FOR DETAILS
NOTE: WE ARE NOW DELIVERING CATALINA'S LEWIS COIN MACHINE SERVICE

3924 W. CHICAGO AVE. CHICAGO, ILL. (BELMONT 7005)

NEW OFFICES TO BE OPENED BY CMAC

CHICAGO — Coin Machine Acceptance Corporation, 134 No. LaSalle Street, this city, announced this past week that they will very soon open new offices, two of these to be located on the West Coast to help coinmen obtain the necessary finance they will require in their own territories.

ARA PRESENTS HOAGY CARMICHAEL

HOLLYWOOD, CAL. — Ara Records have just recorded a new Hoagy Carmichael album for current release. Records were reported to have been cut weeks before the Dick Haymes' radio show where Hoagy's "Stardust" won the title of "Greatest Popular Song Ever Written" by a six to one lead. New album is now being released to the trade and can be obtained at distribs.

[Faint, illegible handwriting on aged paper]

WANTED TO BUY IMMEDIATELY MILLS ESCALATOR TYPE SLOTS

WIRE — PHONE — WRITE

BILL WOLF

M. S. WOLF DIST. CO.

1348 VENICE BLVD.

LOS ANGELES 6, CALIF.

(PHONE: PROSPECT 4131)

OPERATORS — RECORD DISTRIBUTORS

MAKE MONEY WITH THESE LABELS

ATOMIC ★ ★ ★ MEMO ★ ★ ★ SUNSHINE

WE GUARANTEE QUALITY AND QUANTITY
ORDER FROM YOUR NEAREST DISTRIBUTOR

CARDINAL SALES & SERVICE
711 WEST OAK ST.
LOUISVILLE, KY.

SO. COAST AMUSEMENT CO.
314 E. ELEVENTH ST.
HOUSTON, TEXAS

W. M. AMANN DISTRIB. CO.
115 OLIVE STREET
SHREVEPORT, LA.

CLIFF WILSON DISTRIB. CO.
CANIPE DIST. CO.

1121 S. MAIN ST.

TULSA, OKLAHOMA

1049 UNION AVE., MEMPHIS, TENN.

K & M DISTRIBUTORS

1913 W. PICO BLVD.
LOS ANGELES 6, CAL.

SALE! RECONDITIONED CONSOLES & 1-BALLS

Keeney 4 Way 5/5/5/25c P.O.\$495.00	Keeney 2 Way 5/5c, P.O.\$295.00	Paces Reels with Rails, 5c P.O.\$ 99.50
Spinning Reels, 5c P.O. 79.50	Jennings Silver Moon, 5c P.O. 74.50	Jennings Fast Time, 5c P.O. 69.50
Mills Jumbo Parade, 5c P.O. 129.50	Bally Club Trophy, F.P. 219.50	Bally Santa Anita, P.O. 109.50
Bally Kentucky, P.O. 159.50	Bally Long Shot, P.O. 189.50	Keeney Skylark, Comb. 139.50

See. Wall-O-Matic Wireless Boxes (Rec.)\$28.50	Genuine Fibre Main Gears for Seeburg and Wurlitzer (Less Hub).....Sample, each \$4.00—Lots of 10..... Each \$3.50
See. Wall-O-Matic 3-wire Boxes (Rec.) 24.50	Quantity Price, Each 3.00
Volume Control Keys for Seeburg and Wurlitzer— Package of 24.....\$1.00 — Package of 100..... 3.00	Pick-up Coils for all Seeburgs, except 8800 and 9800..... Each 1.50
Casters Heavy Duty Replacement, set of 4..... 1.60	

QUANTITY PRICES TO DISTRIBUTORS AND JOBBERS

TERMS: 1/3 Deposit, Balance C.O.D., F.O.B. Los Angeles, Cal.

FACTORY GUARANTEED AGAINST DEFECTIVE WORKMANSHIP AND MATERIAL

E. T. MAPE MUSIC CO.

(Manufacturing Division)

1701 W. PICO BLVD., LOS ANGELES 15, CAL.

(Phone: Drexel 2341)

E. T. MAPE

284 TURK ST., SAN FRANCISCO 2, CAL.

(Phone: Prospect 2700)

WANTED

TO BUY

IMMEDIATELY

MILLS ESCALATOR

TYPE SLOTS

WIRE - PHONE - WRITE

SEE YOU

M. S. WOLF DIST. CO.

1200 WILSON ST. CHICAGO

1200 WILSON ST. CHICAGO

CHICAGO DISTRICT OFFICE

DISCOUNTS - SPECIALS - PROMOTIONS

SAVE MONEY WITH YOUR LABEL

ATOMIC * * * MEMO * * * SUBSTANTIVE

IN SUBSTANTIVE LABELS

FOR YOUR BUSINESS

Labels are the key to success in business. They identify your products, attract attention, and increase sales. Use Atomic Labels for all your business needs.

Labels are the key to success in business. They identify your products, attract attention, and increase sales. Use Atomic Labels for all your business needs.

Labels are the key to success in business. They identify your products, attract attention, and increase sales. Use Atomic Labels for all your business needs.

Labels are the key to success in business. They identify your products, attract attention, and increase sales. Use Atomic Labels for all your business needs.

K & M DISTRIBUTORS

SALE! RECONDITIONED CONSOLES & T-ALLS

RECONDITIONED CONSOLES & T-ALLS

E. I. WARE

E. I. WARE MUSIC CO.

1200 WILSON ST. CHICAGO

1200 WILSON ST. CHICAGO

ENTERPRISE WILL LABEL RECORDS "FOR USE IN COIN OPERATED MUSICAL INSTRUMENTS"

HOLLYWOOD, CAL.—Frank Berger of Enterprise Records, this city, has come forth with the announcement that his firm will, in the very near future, label their records for juke box operators, "For use in coin operated musical instruments."

Frank Berger stated along with this announcement, "It is, and always will be, our policy to give the juke box operators every possible break in quality and price and we wholeheartedly agree with *The Cash Box* in the use of a label which will benefit the music machine operators exclusively."

For sometime now, as Berger has noted, *The Cash Box* has been asking that record manufacturers make whatever legal arrangements will be required to label their records "For use in coin operated musical instruments." This is the one protection required and desired by the juke box operator.

Such labels will eliminate the many past problems which have arisen with ASCAP and also such highly controversial matters as the

Buckley bill, still pending in the House of Representatives Patents Committee.

It will guarantee the music machine operator that the record he is using is not just "for home use only" but that it is made for use in "coin

operated musical instruments."

Berger is to be complimented by the entire industry for this move. All will look with great eagerness toward the first labels of this nature which will appear on his "Enterprise Records."



**EVERYBODY
TOGETHER!**

Chicago Premiere

OF THE NEW

AMI PHONOGRAPH

**ALL OPERATORS! ALL DISTRIBUTORS!
ALL MANUFACTURERS! EVERYBODY WELCOME!**

Hotel Continental
505 NORTH MICHIGAN AVENUE

APRIL 10 & 11, 1946 • 10 A.M. TO 10 P.M.

**A SENSATIONAL SHOW!
A GOOD OLD-FASHIONED GET TOGETHER!**

NOW DELIVERING
BRAND NEW FACTORY RELEASES

Victory Special	\$589.50
Victory Derby	574.50
Goalee — Total Roll	Each 525.00
Amusematic Lite League	425.00
New Evans Bangtails 5c, J.P., P.O., 7 Coin	596.50
Evans Ten Strike	372.50
Groetchen Columbia Tw. J.P.	132.50
New Mills 5c Vest Pockets	74.50
New A.B.T. Challengers	50.00

JENNINGS SLOTS

Bronze Chief	Super DeLuxe Chief
5c	5c
10c	10c
25c	25c
Paces DeLuxe Cherry Bells	Write
50c and 1.00 play	

IMMEDIATE SHIPMENT

MARVEL'S LATEST NEW REVAMP,
"CATALINA" 249.50 || Hollywood and United Revamps | Each 249.50 |
| Riviera—South Seas | Each 279.50 |
| SPECIAL !! - 10 Jockey Clubs | Each 325.00 |

**We Want FP Consoles
and 1,000 Pin Games**

Cash Waiting Send Complete List |

Terms: 1/3 Deposit, Bal. C.O.D. or Sight Draft

**MONARCH
COIN MACHINE COMPANY**
1545 N. Fairfield Ave. Chicago 2, Ill.
Phone: ARMitage 1434

NEW! **H. C. EVANS & COMPANY CONSOLES
AND ARCADE MACHINES**

NEW! **PACKARD WALL BOXES AND SPEAKERS**
4 DIFFERENT TYPES — NEW PACKARD PLA-MOR PHONOGRAPH SOON!

EXCLUSIVE DISTRIBUTORS for H. C. EVANS & CO.
SOUTHERN CALIFORNIA AND ARIZONA

PACIFIC COAST DISTRIBUTORS
1347 W. WASHINGTON BLVD. (TEL: RICHMOND 5527) LOS ANGELES 7, CAL.



L. A. DISTRIBS ENTER INTO AGREEMENT WITH AOLAC NOT TO SOLICIT FOR DIRECT SALES



SAMUEL (CURLY) ROBINSON

LOS ANGELES, CAL.—Distributors and jobbers in this area are signing an agreement with AOLAC (Associated Operators of Los Angeles County, Inc.) this city, headed by Samuel (Curley) Robinson, not to solicit business for direct sales to locations.

The agreement reads: "Resolution. In consideration of each of the Jobbers and Distributors of amusement machines joining in this agreement and signing their names hereto, we the undersigned distributors and jobbers hereby agree that we will not solicit the sales of our games, whether pinball, skeeball or music machines, to any person or persons who are not bonafide operators of such games; that we will refrain

from calling upon, or having our salesmen call upon retail merchants establishments for the purpose of selling such games direct, but will at all times refer any such inquiries which we might receive to the Associated Operators of Los Angeles County for the purpose of having the solicitee called upon by a member of the association or any other bonafide operator."

The agreement was also sent on to Ventura, Calif. coinmen by "Curley" Robinson. These coinmen had asked him for this resolution after he had spoken to them.

The attorneys for AOLAC are reported to have carefully gone over the above resolution and have found that it is legal in every respect. They believe that this is the one and only method which can be used to halt any possible direct sales.

NEW RELEASES
COIN MACHINE FILMS
 FOR
PANORAM OR SOLOVUE
100 BEAUTIFUL GIRLS
IN 18 DIFFERENT WHEELS
\$36 PER WHEEL
OF SIX SUBJECTS
 SOUND OR SILENT
 * * *
QUALITY PICTURES CO.
 5634 SANTA MONICA BOULEVARD
 HOLLYWOOD 38, CALIFORNIA



STERLING "POPS" UP WITH RUBY NEWMAN AND HIS ORCHESTRA

STERLING No. 7003 — APRIL RELEASES — STERLING No. 7004

"I'M A BIG GIRL NOW" Vocal by Vera Holly	"IT SEEMS LIKE OLD TIMES"
"DON'T BE A BABY, BABY" Vocal by Michael Revell	"IT COULDN'T BE TRUE" Vocal by Michael Revell

STERLING No. 7002—"WHERE DID YOU LEARN TO LOVE" and "ALL THRU THE DAY"
 Tommy Jones and his Orchestra . . . Vocals by Louise Tobin

And Of Course . . .
STERLING No. 7001—"ONE-ZY, TWO-ZY" and "WE'LL GATHER LILACS"

STERLING RECORD, Inc. LIST PRICE 75c plus tax
 7 W. 46th ST., New York

IT'S DYNAMIC!

"SUSPENSE"

- "SCHEMATIC PANEL"
- VISUAL BALL LIFT

ORDER FROM YOUR JOBBER OR A WILLIAMS REGIONAL DISTRIBUTOR

Williams
 MANUFACTURING COMPANY

161 W. HURON ST. CHICAGO 10, ILLINOIS
 JOIN CMI NOW!



DISTRIBUTORS FOR

Bally

UNDERSEA RAIDER.....ONE PIECE ELECTRIC GUN
VICTORY DERBY.....1-BALL MULTIPLE CASH PAYOUT
VICTORY SPECIAL.....1-BALL MULTIPLE FREE PLAY
SURF QUEEN.....5-BALL FREE PLAY

WRITE US ON OUR TIME PAYMENT PLAN

MINTHORNE MUSIC CO.

2920 W. PICO BLVD.
 LOS ANGELES, CAL.

512 W. WASHINGTON STREET
 PHOENIX, ARIZONA
 ROBERT S. ANDERSON, MGR.

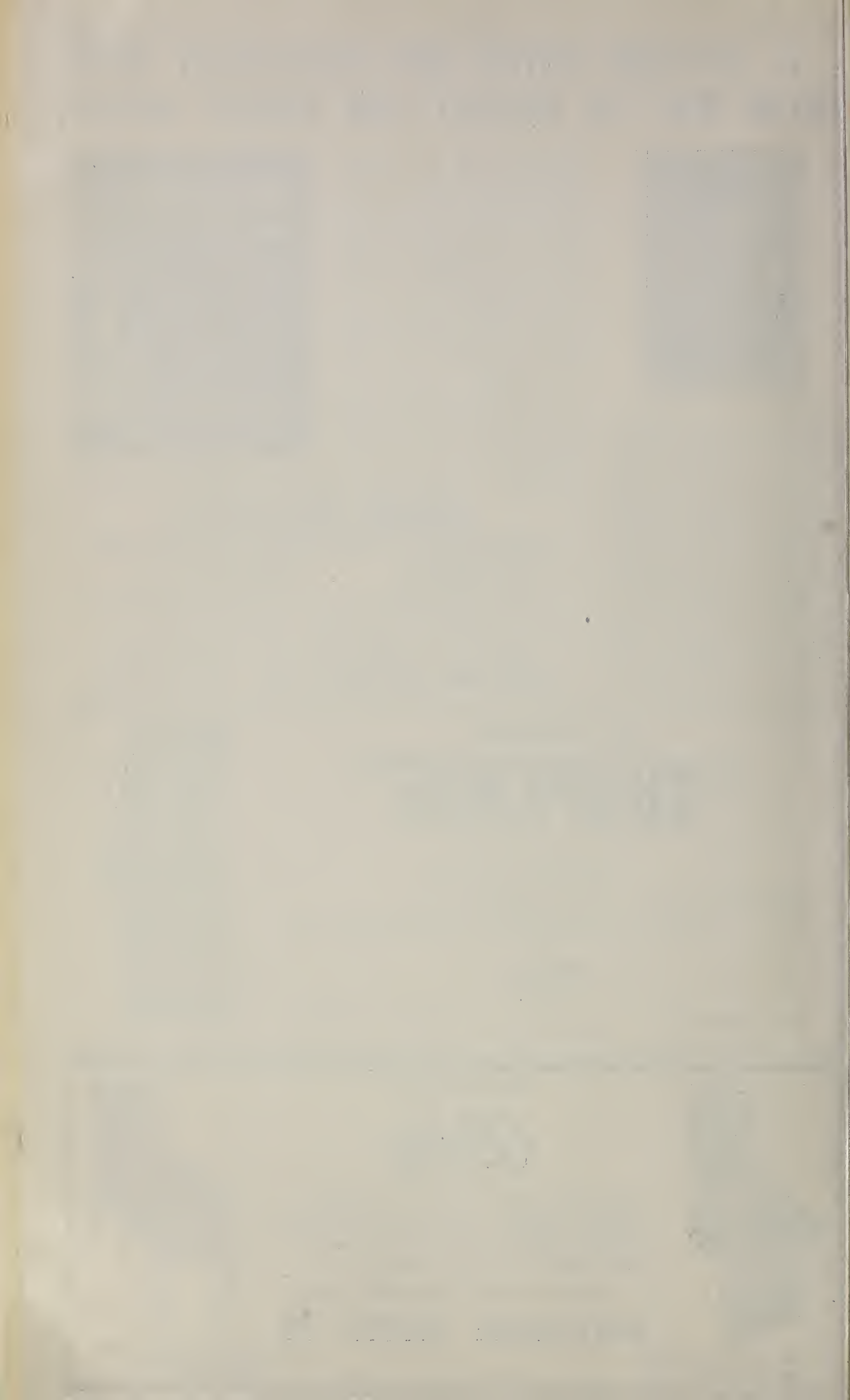

THRU THE COIN CHUTE



CHICAGO CHATTER

Now that Dave Gottlieb is back from a month's stay in sunny Florida and brother Sol still on the road looks like action will start humming even more than ever before and give Nate Gottlieb a chance to ease off a bit. Nate's been working harder than ever while Dave was away. Sol is reported to be preparing a trip to the West Coast to visit with all the many friends he has there on his return to the offices here . . . J. R. Bacon who is Vice-President of O. D. Jennings & Co. is on the West Coast contacting many of the firm's distribs. At this plant things are really hummin' at top speed to rush the showing of the firm's new machines. And plenty interest in these from all over the trade, too . . . Harry Brown of American Amusement has found a new way to reduce. He's seeking a new factory site. That's all, brother. Just try it yourself. Chase around here, there and everywhere all day long and you, too, will wear yourself thin — just like Harry. By the way American have blue-printed a batch of new games which will go into immediate production the moment they locate their factory site.

Henry Fox of Jackson, Miss., New Orleans, La. and Birmingham, Ala. and a dozen other points south — in town this past week and told us that he had just sold out his interest to Jules Peres and O. C. Marshall. Henry reports that he has opened up his own firm at 1010 Poydras St., New Orleans, to be known as the Henry Fox Wholesale Coin Machine Co. He was in Chi he tells us, "Jus' to make a coupla slot deals. How-manyagot?" . . . There's a picture of Dave Helfenbein of Daval on the wall of his office, right back of his desk, that some of you guys will get a great kick out of seeing. And, by the by, Dave just celebrated his 40th wedding anniversary this past week. Ain't that somethin'? . . . Can't take away luck from the lucky. Take Al Stern, for instance. He sure is lucky to have such an efficient secretary and office assistant as Shirley Slutsky. Shirley has been with the coinbiz for several years and knows who's who and what's what. She sure knows how to make visitors feel welcome and right at home. And in addition keeps the office and every department at World Wide running in tip-top shape.

Dave Gottlieb, president of CMI (Coin Machine Industries, Inc.) has called a meeting of the Board of Directors to be held Tuesday, April 2, at which time the election of officers will take place. Many discussions will take place for plans are under way for the first post-war convention. Announcements of the dates for the show will be forthcoming very soon . . . Here's the exception to the rule: if Gil Kitt of Empire Coin moves in one more piece of equipment some of the help will have to move outside. The place is simply jammed to the rafters and Kitt is tearing out his jet-black curly locks one by one because he is unable to move into his recently acquired building until the tenants who now occupy it find a place to move into themselves. The strides this boy has made in the past four years read like an Alger story . . . Lou Wolcher of Advance Automatic Sales Co., San Francisco, who spent about a week in the Windy City and then flew to New York returned this past Thursday early A.M. to be greeted by a regular welcoming committee. Lou is on his way back to S.F. for a throat operation.

Seen in the Celtic Cafe of the Sherman Hotel this past week — Vince Shay (who is now president of the new Bell-O-Matic Corp.) telling a gathering of coinmen which included: Bill Marmer of Sicking, Inc., Cincinnati, O., Al Silberman, executive vice-president of Williams Mfg. Co., Chicago, Delbert and Norwood Veatch of St. Louis, Mo., Al Sebring and Harry Salat of Bell Products Co., Chicago, Al Stern of World Wide Distributors, Chicago, Joe Beck of Mitchell Novelty Co., Milwaukee, and a few more, all about the way that coin-games can gain greater favor with the general public. And the boys wholeheartedly agreed with Vince's views on this important matter . . . Al Stern and Tony Gasparro seen talking it over in the Celtic over a couple

of steaks . . . George Jenkins of Bally Mfg. Co. among the busiest executives in town with three phones constantly ringing away at him — and nearly every call long distance and everyone asking for more and still more delivery of the firm's new games.

We've been warning you about being double certain that you have a hotel room before you get to town — so take heed from the way that Paul Fuller of Wurlitzer, Joe Beck of Mitchell Novelty Co. and Del and Norwood Veatch were caught short this past week. Just lucky that other coinmen had rooms and were able to make way for these boys — otherwise they would have been forced to sleep on one of those hard, green benches they have in Grant Park . . . Jack Keeney and Bill Ryan of the "House that Jack Built" are two of the hardest guys in all this big city to catch up with these days. Both Jack and Bill are constantly on the go out there at their big factory and trying with every kind of know-how to get those Keeney machines rolling to their distribs throughout the country.

A. R. Kelson of Rockola Mfg. Corp. telling us about a test that is still going on to find out how long their new mechanism can play without any mechanical fault. It seems that so many thousands of plays have been made that it would have taken over \$10,000 worth of nickels to catch up to them. And the mechanism is still running without halt in the factory. He also described methods used by the firm to surprise even their own distribs on the shipments of the first sample "phonograph of tomorrow" with many Rockola distribs opening the case without even knowing what it contained . . . Richard Cole of Challenge Industries in the midst of preparing an unusual and different type ad campaign for the firm's new "Challenger '47" phono, stops long enough to demonstrate the machine to use in the peace and quiet of the firm's showrooms (and that's the first time it has been quiet in weeks) and tell us what a great reception it received from all who have so far seen it.

Earl Montgomery of Memphis, Tenn., who spent a few days in Chi, actually drools when he talks about the new Rock-Ola. Earl is getting around to the point now where he orders by the carload only. We understand, tho, that he broke this rule when speaking to Art Weinand at Rockola by asking for a "trainload," and over at Harry Williams he was saying that a shipment of "five carloads of Suspense" wouldn't hurt too much at this time, either . . . B. D. (Briefcase) Lazar of Pittsburgh telling some of the boys in Chi around the dinner table (and with appropriate gestures) how he had to fight off customers who insisted on ordering 50 and 100 of the new Rockola phonos. Before the war, Lazar explained, when an operator ordered 50 phonos, "You would chain him to a chair, bring in a bottle of Hennessy's 3 Star, a tray of crepes suzettes, take him home with you and put your wife in his lap, until you found your order book." Yes, B.D., we agree with you — "times have changed."

Mac Churvis tells us to absolutely refute the claims of anyone who says he is now working for a weekly magazine. Mac claims there is no truth in this rumor and that it is only a rumor . . . You will soon see a movie made of Jim Mangan's writings pertaining to the art of selling yourself. These will be in a series of six movie reels and are being made of Jim's books by the Dartnell Corp., 4660 N. Ravenswood Ave., Chicago. Jim has been one of the well known writers on this subject. By the way, his book on automatic merchandising is still the one most coinmen refer to . . . And that reminds me, if you have a snake ring, Doc Eaton will buy it. He collects 'em . . . Gordon Mills of Mills Industries flies out to N.Y.C. on the TWA Constellation and can't get over the fact that this big 4-motored giant makes it in only 2½ hours. And Gordon was very much interested in this flight for he will solo for the first time this coming week. After which he intends to buy himself one of those small aquaplanes.

CHATTER CHICAGO



WHITE

... of Bell, Miss. Co. among
with three phones con-
and many every call
more and still

1 in
-0

THRU THE COIN CHUTE



EASTERN FLASHES

The event of the week was the premiere showing of the AMI phono at the showrooms of Runyon Sales Company of New York on Tenth Avenue. The heads of the firm Barney (Shugy) Sugerman, Abe Green and Mike Munves were exceptionally happy that John Haddock, President of AMI, was their guest. The Runyon staff were all on hand. Jack Mitnick, Bernie Wolfson, Joe Munves, Herman Perin (who came in off the road for the opening days), Felix Fleischman, Irv Kempner welcomed their friends. Guests included other AMI distributors . . . Sam Strahl, American Coin-A-Matic Co., Pittsburgh, Pa., David Rosen, Philadelphia, Harry and Sam Wichansky, Atlas Vending Co., Elizabeth, N. J.; Hy Singer, Buffalo, N. Y. and Jules Olshein, Jules Olshein & Co., Albany, N. Y. In addition to Mr. Haddock, other AMI officials on hand were Lyndon C. Force, James Hyde, assistants to DeWitt (Doc) Eaton, general sales manager, and Monte West, phono service and mechanical expert.

Jerry Kertman, American Sales Co., Rochester, N. Y., visits the city once again, still trying to buy equipment. With Jerry is "Scotty" Caplan . . . Ed Schaefer, Buffalo op tries hard to get plane reservations back home. Wonder if he got out . . . F. Mc Kim Smith, arcade owner at Atlantic City, N. J. in town for the Arcade Owners Assn. meet, and happy about being able to run his arcade at the same location as last year. Liggett's Drug Co., who own the property, planned on building a store, but were unable to secure materials, and now won't build until 1947 . . . H. B. Fowlkes and W. R. Barber of Southern Vending Co., Danville, Va. ("Boots" Strange's company) in town buying. Fowlkes tells us that "Boots" is down at Coral Gables with his missus, and sees quite a bit of Harry Moseley, who has a tomato farm there . . . Nat Cohn, Modern Music Sales Co., sporting a deep tan — without going to the deep south. All Nat needs is a little sun over a week-end at his Belle Harbor home. Why don't you get Earl Winters out for a little of that sun, Nat?

Al Schlesinger in town for a few days visiting Jack Fitzgibbons. Al claims it's for business, but we have an idea it was to sell Jack on going back to Poughkeepsie to help him out with that Shad fishing. Fitzgibbons claims he's too busy taking care of the biz on his "Roll-A-Ball Barrel Roll," universal amplifiers, and Williams' "Suspense" . . . Leo Knebel, Manhattan Phonograph Co. (Aireon distributors) anxiously awaiting the arrival of the "Fiesta," the standard model phono, and a smaller job than the Deluxe model, which he informs will be in his showrooms in a couple of weeks. At that time, Leo adds, deliveries of both models will be coming thru. Dave Margolin, after the hectic days of the official showing, down in Miami for a short rest, and will be back for the big action in a week or so . . . Willie Levy and Georgie Holzman back from Florida . . . So is Abe Block of Melody Music Co.

Len E. Kelly of K & M Distributors, Los Angeles, Cal. (record distributors) drops into the office for a chat. Kelly has been on a selling trip, covering 16 states and about 10,000 miles since February 12. Now he's headed for home, but will continue to

drop off seeing his distributors on the way . . . Premier Music Co., formerly a partnership, has now been incorporated with Nat Schiffman, president, Dave Lutzker, vice president, and Theodore Blatt, secretary-treasurer. Company runs remote music . . . Ed Ravreby, Associated Amusements, Inc., Boston, Mass., reports he will soon be holding a preview of the new 1947 model Mills Panoram, which has many changes. Ed will also distribute the Mills new cigarette machine in his territory .

Irv Morris, Active Amusement Machines Co., Newark office, in New York looking over the AMI machine, and at the same time meets many of his friends. If there's a more popular guy than Irv, we haven't met him. Meanwhile Joe Ash kept pretty close to his desk in Phila. Hey, Joe, the Russians are asking for you! . . . Bob Slifer, General Manager for East Coast Sales & Dist. Co. (Rock-Ola distributor), a tough man to see these days. He's always busy with operators. Harry Pearl is back on the job from a Florida vacation — now the combination of Dave Stern, Tom Burke and Everett Masterson can now really go to work . . . Moe Luber, that expert motor man, gets along on only 4 hours sleep every night. Not an Edison — but his 7 week old baby keeps him walking the floors — and he don't like it one bit . . . John Connelly, Connelly Vending Co., another papa who does night calisthenics with his new son, Thomas.

Bill Blumenthal, manager of the New York offices of Tri States Sales, and Warren Ryan, manager of the Newark, N. J. offices of the same company, welcome Charley Polgaar back from Florida with open arms. Charley can now join his managers in trying to satisfy all their customers who are tearing them apart for Bally's "Victory Special," "Victory Derby," and "Surf Queens" . . . Is it true that Dave Stern of East Coast Sales & Distributing Co., is growing a mustachio? . . . The Firestone family still operating and inventing. Bud is running cigarette and amusement machines, Jack is presenting the new "Supreme Skill Roll" and "Pop" continues to operate in Brooklyn . . . Lester Klein now in the bowling alley business . . . So is Arthur Malamed . . . The Marcus brothers anxiously looking forward to opening their arcade in Rockaway in a few weeks . . . George Ponser and Irv Kaye, Amusement Enterprises Co., will be shipping tremendous quantities of "Bank Ball" beginning this week, as their factory is now running full blast . . . Hy Singer, Buffalo, N. Y. distributor for AMI brings ten operators to New York City with him, and entertains them royally.

Gordon Mills and Dennis Donohue of Mills Industries, Inc., in town, and insist that *The Cash Box* be rushed up to their hotel . . . Al Blendow, Sales Manager and Bill Rabkin, president of International Mutoscope Corp., shipping their "Voice Recorder" and will have some news for the trade in a short while . . . Hymie Rosenberg, H. Rosenberg Co., who returned from Chicago only a week ago, might have to go back to the Windy City again . . . Harry Berger's (West Side Distributors) mark of identification — a cigar and a bow tie . . . Lou Rosenberg, former op, now manufactures toys.



THRU THE COIN CHUTE



CALIFORNIA CLIPPINGS

Bill Wolf, of the M. S. Wolf Distributing Co., was a very busy man this past week in getting things ready for his premier showing of the new AMI phono. By the time this appears Bill will be all set to hold his second showing in San Francisco. Bill gave some of us a sneak preview of the new machine and it looked and sounded plenty good to us.

Jack Gutshall, now national distrib for Exclusive, G & G and modern records, reports that the music operators will be more than pleased with the newest and latest hit recordings his firm is about to release. Jack says these latest discs will prove real money makers to the ops. Jack's very capable assistant, Jack Allison, is right on the job keeping things rolling in the office and shipping rooms. That pretty little secretary that Gutshall has keeps the back room boys hanging around the front office. You can't blame 'em. She's plenty purty.

Bill Happel, Jr., of Badger Sales, says that he had practically sold his year's quota of the new Rock-Ola in the first week of its showing. Bill had to take a few days off after the big rush and took a trip to Palm Springs, where he spent some time with Harold Murphy of the Palm Springs Music Company, Jim Hugh and Jack Healy. William E. Happel, service manager of Badger Sales, is taking a month long vacation and going to Chicago . . . Add another travel note: Claude Frankenfield of Paul Laymon's, going to New York.

M. E. Thiede, General Sales Manager of Navarro Distributing Company, reports that his firm is taking a great many orders for the new Aireon phono, and the ops down Mexico way are going for it in a big way. Thiede tells us that Frank Navarro, now in Mexico, is due back any day . . . Encore Record Company, a new platter firm recently set up locally, is about to announce a large group of new disc releases, according to Dave Ward, General Manager.

The ops in this area are getting busy and spending more time in town looking things over. The following were seen window-and-otherwise shopping this past week along coin row: Bill Knight and Frank Abbott, Alhambra; Johnny Nelson, Inglewood; Lee Walker, Gardena, James Mills, Downey; L. D. Smith, Downey; Bernard Knott, Alhambra; Jim Murphy, Inyokern; Earl Cale and Harold Sharkey, L.A.; Anton Jeppeson, Maywood; C. A. Tomlinson, Visalia; Homer Gillespie, Long Beach; Dean Brown, Glendale; C. E. Collard, San Bernardino; Art Narath, Anaheim; Dwight Towne and I. B. Gayer, San Bernardino; George Landier, Long Beach; Pete Peterson, Delano; L. J. Bender, Lynwood; Scott Dreyer, Pasadena; Walter Murra, Downey; J. H. Sheeter, San Gabriel; W. Knudson, Provo, Utah; Shirl Swenson, Las Vegas; Ray Smith, Barstow; Mrs. Roy Smith and Clifford Smith of Lancaster; D. A. Hogan and Roy Garrison, Phoenix.

Len Kelly and Fred Myers, K & M Distributors, are on their way home after a terrific selling tour of discs the firm is distributing. Both boys are due back in town shortly . . . Jean Minthorne has been receiving some new Seeburg phonos and says, "Now I know the spot Solomon was in when I have to divide up 50 phonos among 500 clamoring ops. But

I'll make 'em all happy before it's all over" . . . Nels Nelson is really busy servicing music boxes. One look into his shop and showrooms is all you need. Nels has recently hired two new mechanics, Bob Simpson and Henry Trevino . . . L. B. McCreary of Solotone says he is very well pleased with the response of ops to the new box the firm is distributing.

Charlie Robinson, C. A. Robinson and Company, has recently closed a deal wherein he will install 200 Bronze Chiefs in a club in Las Vegas . . . A report has just been received that William A. (Bill) Wulf, well known local op, has been severely injured in an automobile accident . . . Lane Jasper, Packard Field Service Rep for the eleven Western states, has just purchased his second new car within a month. How do you do it, Lane?

Frank Berger, Berger Enterprises, reports that his firm is about to start pressing the same number on both sides of the platter and will label the discs for use in juke boxes only. The records will continue to sell at the same 55c price less the regular discounts. Frank says he would appreciate comments or suggestions from the ops. Having been bed ridden for some time, Frank is now mending and it is hoped he'll be back on his feet before long.

Elky Ray of the Gold Coast Coin Machine Exchange has been ill for the past few weeks and is not expected to be up and around for another week or two. Get well soon, Elky. We'll watch your building go up for you in the meantime. It won't be long now . . . Quality Pictures are about to release a new set of 16 MM coin machine films to the ops. Among the many stars they feature are, Gail Miller, Jinx Lane, Donna Masters, Lucia Rand and Zedra Conde. The numbers are reported good and they are expected to draw plenty of dimes at the Panoram and Solovue spots . . . Tom Boddy, well known op from Lomita, reports that his son is just out of the Navy and going into business with his father.

Paul and Lucille Laymon report they've been staying out of the social world lately. "We have been so busy during the day that we're just too tired to go out at night," they say. Paul did get in a round of golf with Al Sleight, the Bally man and Tom Wall. Lucille kept score, but when the game was over they couldn't figure out who won . . . William Leuenhagen reports he will sell a lot of phonos and games at a low price to clear the decks for new equipment . . . Ray Powers reports the new phono line the firm will handle should be in town soon. Announcement of the showing will be made.

John Rough of Phonofilm Productions has a great many new coin machine movie films ready for the trade and is mailing out a new catalogue . . . Otis Rene of Excelsior Records informs us that he has just completed a new recording of "Cement Mixer," which he says will prove a tremendous hit in the phono field . . . Ed Urban, Urban Records, has completed setting up his own pressing plant and now records his own artists . . . Aubrey Stemler, formerly organizing director of the Music Operators Association of Southern California, has opened a new show room on Pico and will distribute a new line of well known phonos. Aubrey will make the announcement soon.



THRU THE COIN CHUTE



MINNEAPOLIS BALTIMORE

Back from their Florida vacations have come Harold Lieberman of the Acme Novelty Company, Hy Greenstein of the Hy-G Amusement Company and Fred Grohs . . . George Atol of the P and M Sales Company stopped off in Minneapolis with his family to visit friends . . . Noel Hefte of Grand Forks in town for a couple of days. First in many a moon.

Izzie Alpert of Twin Ports Sales Co., Duluth, Minn., in town for a few days, visiting friends and seeing all Twin Cities distribs . . . Oscar Winter, of La Crosse, Wis., in town. It's his first trip here since the snow left the highways, and he came in driving a brand new 1946 Ford sedan. . . Mr. and Mrs. Gerald C. Johnson, both tired and very busy, spending a couple of days here after a trip to Milwaukee; then they go back to Menomonie.

Congratulations to Norman Hansen who became the daddy of another baby boy . . . Mark Coughlin of Mankato in town for a look-see at the new phonos . . . Ike Sinkey of Shell Rock, Iowa, visiting the distribs in the twin cities. His first trip there in several years . . . Mrs. Mildred Birkemyer is happy as a lark with the new cabin she purchased, and she's looking forward to lots of fishing this coming summer . . . P. Y. Young of Osceola, Wisconsin, in town . . . Chuck Karter, recently discharged from the service, vacationing with his wife in South Dakota, before returning to the Star Novelty Company . . . Joe Blenker, Wisconsin, taking life a lot easier and visiting the Twin Cities nite spots more often . . . Norman Gefke, Sioux Falls, S. D., spending a few days here visiting distribs.

Ken Willis of Bush Distributing Company reports Goalies selling very strong, with deliveries on the new Aireon expected very soon. Ted Bush, writing from Hot Springs, says he's having a terrific time and not at all anxious to come home . . . Matt Ingalls, Mayflower Distributing Company, says they can't keep up with the Bally Victory Derbys. That's how fast they're going. Herman Paster buzzing in and out of town . . . Hy-G Amusement Company calls the Stage Door Canteen the most terrific five-ball game ever built . . . Oscar Trupman, Bush Distributing Company, back from a trip to Wisconsin.

The new showrooms of Silent Sales have been completed and are a pleasant sight to behold. The "Sphinx" — Bill Cohn — should really be surprised when he returns from Miami. Benny and Dave are really proud of the new sample Keeney Super Bell they're showing and expect a flourishing business with it . . . Ray Selma, formerly with the Concord Novelty Company, is back at his old roost, the LaBeau Novelty Company. Kenny Glen, of the same firm, has been very busy making out of town calls this past week.

Irv Blumenfeld of The General Vending Sales Corp., is one of the busiest coinmen in town these days. Irv has been appointed to head the "vending machine division" of the United Jewish Appeal drive for this city . . . Harry Hoffman and George Goldman also of General are very busy these days with Irv hard at work for UJA and report that their bowling game, "Bank Ball," has been coming in and going out just as fast as they arrive. And every so often the boys rush over to watch the construction of their new building. With the way the contractors are at work here they believe that the firm will be able to move in about July 1 . . . Jack Kramer of Hagerstown, Md. seen around the town doing some buying this past week . . . Bunny Levenson of Baltimore is buying more and still more equipment these days. Looks like Bunny will be expanding his route over the top very soon.

Jack and Abe Guller, father and son, formed an operating team, the moment that Jack got out of service and they are going along very well. We note the team buying more equipment last week and smiling while buying — which is a good sign in any man's business . . . Sam Gensler who has just come out of service six weeks ago has his route going again and in very nice shape. You can depend on Sam to make this one of the best little routes in this man's town . . . A. E. Cramer of Frederick, Md. is buying more music equipment and is getting ready for a real expansion program . . . C. L. Parsons of Brunswick, Md. also buying more equipment and concentrating on pins and music . . . L. LaFevre of York, Pa. can't get new games so he takes all the used games he can obtain and is doing very well . . . Four boys back from the service and working over at the General are: Irving Block and his brother, Joe, John Corter and Tom Hale. Nice to see youse guys back again . . .

Jack Ridenour of Hagerstown, Md. is buying more music equipment and is reported to have some great plans for one of the best operations in his part of the world . . . The Parsons brothers over in Salisbury, Md. are reported to be doing a neat little job themselves in music and are getting ready to show the coin machine business how to operate — but successfully . . . Stacy Lewis, biggest op on the eastern shore, from Cambridge, Md., is going along full speed these days . . . G. M. Summers of Frederick, Md. is doing good with slots, we hear . . . Grafton Downs of Williamsport, Pa. is also reported to be enjoying this operating life . . . Sydney Shapiro, recently discharged, started up Shell Amusement Co. and has rebuilt his route into a going business. Seems like Syd knows just what to do and when to do it, too.

THE UNIVERSITY OF CHICAGO
LIBRARY

THE UNIVERSITY OF CHICAGO PRESS

[The remainder of the page contains extremely faint and illegible text, likely bleed-through from the reverse side of the document.]

THE CASH BOX

CLASSIFIED ADVERTISING SECTION

COIN MACHINE MART

CLASSIFIED AD RATE

50c PER LINE — COUNT SIX AVERAGE WORDS TO THE LINE. COUNT NUMBERS IN YOUR ADDRESS AS ONE WORD. MINIMUM CLASSIFIED AD ACCEPTED \$2.00.

WANT

WANT — All models of music machines. Write, wire, phone. AMERICAN COIN MACHINE CO., 437 ELIZABETH AVE., NEWARK 8, N. J. Tel. Waverly 3-1500.

WANT—Phonographs, any make any quantity. Advise fully what you have. AMERICAN DISTRIBUTING COMPANY, 2034 COMMERCE STREET, DALLAS, TEXAS. Tel. Riverside 1526.

WANT—Seeburg Vogues, Seeburg Envoys, Wurlitzer 700's. Highest cash prices paid. Write, wire or phone, JAY MUSIC CO., 41 S. MAIN STREET, HAVERHILL, MASS. Tel. 3636.

WANT — Seeburg, Wurlitzer, Rock-Ola, Mills, all models. Highest cash prices paid. Write, wire or phone and we'll give our highest offer within 24 hours. DAVE LOWY & COMPANY, 594 TENTH AVE., NEW YORK CITY, N. Y. Bryant 9-0817.

WANT—Seeburg 30-wire boxes and used records. DAVIS DISTRIBUTING CORP., 625 ERIE BLVD. EAST, SYRACUSE 2, N.Y.

WANT—Bally Hi-Hand Machines, combination free play and payout console models. Kindly contact us at once. Cash waiting! QUEBEC COIN MACHINE EXCHANGE, 1247 GUY ST., MONTREAL 25, QUE., CAN., Tel.: Fitzroy 7404.

WANT—Any quantity of Genco's Boscós, Capt. Kidds and Argentines. State condition and price. R & Y NOVELTIES, 131 CLINTON AVENUE, NEWARK 2, N. J. Tel. Market 3-6105.

WANT—Rock-Ola 1938 Monarchs and 1939 Standards. These must be in good condition and complete. Write giving best price at once. Hurry before price drops any lower. LIBBEY MUSIC CO., 66 PHOENIX ROW, HAVERHILL, MASS. Tel. 3798.

WANT—We will buy Western Baseballs, all models except Majors. Write stating quantity, models, condition and price. If they are not complete or parts are damaged, please explain. RUSSELL N. GOSSELIN, 81 WASHINGTON STREET, LYNN, MASS. Tel. LYnn 2-1993.

WANT—All model Keeney Super Bells combination Free Play and Pay-Out; Mills Three Bells; Mills Four Bells; Mills Jumbo Free Play, late Blue and Red; Mills Jumbo Combination F.P. & P.O.; Bally Hi Hands; Bally Club Bells. Will pay top cash prices. Write today. BADGER SALES CO., 1612 WEST PICO BLVD., LOS ANGELES 15, CALIF.

WANT—Will pay top cash prize for 750 Wurlitzers and Rock-Ola counter models for my route. Also want electric selector for 750 Wurlitzer. MURRELL AMUSEMENT CO., 1058 S. FLORIDA AVE., LAKE LAND, FLA. Tel.: 25-413.

WANT—Chester Pollard Football at \$75. IDEAL NOVELTY COMPANY, 2823 LOCUST STREET, ST. LOUIS, MO.

WANT—.22 calibre shells; Seeburg or Wurlitzer ESRC phonographs; Club and Super Bells National or Rowe cigarette machines. Write best price, condition and quantity. W. H. LEUENHAGEN & COMPANY, 1813 W. PICO BLVD., LOS ANGELES 6, CAL.

WANT—Mills 1-2-3's, '41 Free Play Models. State price and condition. NEW ORLEANS NOVELTY CO., 115 MAGAZINE ST., NEW ORLEANS, LA. Tel. PA 7904.

WANT—Buckley Twin 12 or 24 mechanisms. Advise quantity, price and condition. M. LUBER, 503 W. 41st STREET, NEW YORK, N. Y.

WANT — Mills Four Bells; Jumbo Parades P.O.; Mills Three Bells, Mills Four Bells 5c 5c 25c. BELMONT VENDING CO., 703 MAIN ST., BRIDGEPORT, OHIO. Tel: Bridgeport 750

WANT—Liberty F.R. \$8.; Cigarette \$5.; Sparks Champion F.R. \$8.; Sparks Mercury, American Eagle and Marvels \$5.; Aces, Imps, Cubs and Daval 21 \$3.; Vest Pockets \$25.; Columbias \$15.; Col. Vest Pockets, Yankee, Wings, Pokereno. Send list and details. ABCO NOVELTY CO., 809 WEST MADISON ST., CHICAGO, ILL. Tel. Hay. 3695.

WANT—Distributorship wanted for pin ball machines. Business reference, bank and character references furnished upon request. 20 yrs. experience in this business. Write or phone. RELIABLE COIN MACHINE COMPANY, 192 WINDSOR ST., HARTFORD 5, CONN. Tel. 6-3583.

WANT—We want to buy phonographs and pin games. Will pay top cash price for Rock-Ola Standard, Wurlitzer 600 and 750E. Can use any kind late pin games. Wire, phone, write to HIRSH COIN MACHINE CO., 1309 NEW JERSEY AVE. N.W., WASHINGTON 1, D.C.

WANT — Genco Total Rolls, either new or used. FRANK AMENDOLA, 3043 FERRY AVE., NIAGARA FALLS, N. Y.

WANT—Popular current used juke box records, not over 1 year. Will pay 9¢ each if you pay freight, or 8¢ each and we will pay freight. Jack Rubin. TELAUDIO CORP., 106 SOUTH OXFORD ST., BROOKLYN, N.Y. Tel. Nevins 8-2236.

WANT—Jennings Free Play Slots; Free Play Games and Consoles; Scales; Arcade and Counter Games. Canadian Operators. Write for our price list on all Coin Operated Equipment. ST. THOMAS COIN SALES LIMITED, ST. THOMAS, ONTARIO CAN.

WANT—We will buy any kind or make of slot machine in any condition. Write full particulars of type, price and condition. NOTE: We repair, refinish and service all types of slots. Over 20 years of shop experience. G. B. SAM, 541 EAST 32nd ST., LOS ANGELES II, CAL. Tel. Adams 7688.

WANT—Late Model phonos, pin games, consoles, slots and old 12, 16 or 20 record Rock-Olas. Write stating prices, etc. NOBRO NOVELTY COMPANY, 369 ELLIS STREET, SAN FRANCISCO, CALIF.

WANT—The following backboard glasses: Long Shot, Fortune, Dark Horse, Club Trophy. WANT — Mills Free Play Mint Vendors. State price and condition. WESTERN DISTRIBUTORS, 1226 S.W. 16th AV., PORTLAND, OREGON.

WANT—Safes for slot machines. Any kind. Give description and price wanted in first letter. H. M. BRANSON DISTRIBUTING CO., 516 SOUTH 2nd ST., LOUISVILLE 1 KY. Tel.: Wabash 1501.

WANT—30-wire Wall Boxes, Adapters, etc.; old model phonographs in good order. WINNIPEG COIN MACHINE EXCHANGE, 277 DONALD ST., WINNIPEG, MAN., CANADA.

WANT—Bankrolls, Wurlitzer Skee Ball A-leys and Music Boxes, S & W COIN MACHINE EXCHANGE, 2416-20 GRAND RIVER AVE., DETROIT, MICH. Tel. CLiford 1956.

WANT—Mills Three Bells; Keeney Super Bells F.P.-P.O.; High Hands; Jumbo Parade late F.P.; Mills Four Bells, late heads only; Keeney Four Way Super Bells 3/5 and 1/25c play. NO JUNK. Must be good. State quantity, price and guaranteed condition in first letter. Write NOW. ADVANCE AUTOMATIC SALES CO., 1350 HOWARD ST., SAN FRANCISCO 3, CAL.

WANT—All kinds 5c Selective Candy Bar Vendors; 1c LoBoy weighing scales; coin counters; changemakers; 1c gum vending machines. Send full details and price in first letter. R. H. ADAIR CO., 6925 W. ROOSEVELT RD., OAK PARK, ILL.

WANT—CASH WAITING! For any quantity Bally Hi-Hand convertibles, must be in good condition. M. A. POLLARD CO., 725 LARKIN ST., SAN FRANCISCO 9, CALIF.

WANT—5# Peerless Grandma Horoscope Machine; 10¢ Astro-Scope Machines where the little man's arm moves up and down in front of the machine; 5¢ Doralinda Grandma Prediction Machines; 5¢ Grandma Prediction machines of the Wm. Ghent Manufacturing Company make of Cleveland, Ohio. Quote lowest prices. Machines must be in good condition. C. J. FENDRICK, 2671 EUDORA ST., DENVER 7, COLO.

WANT—"Bang-A-Deer" Machines complete with Guns. Write stating price, quantity and condition. MYCO AUTOMATIC SALES CO., 347 S. HIGH ST., COLUMBUS 15, OHIO. Tel. Main 1600.

FOR SALE

FOR SALE — 4 Supreme Skee-ball 9½ ft. \$225. ea.; 1 Supreme Skee-ball 7½ ft. \$175.; 3 Genco Playball, late \$145. ea.; 3 Chicoin Hockey \$195. ea.; 4 Anti-Aircraft Brown \$49.50 ea.; 3 Batting Practice \$95. ea.; 1 Supreme Poker Table \$79.50; 2 Keeney Submarine \$99.50 ea.; 1 Genco Skee Roll 9½ ft. \$179.50; 1 Goofy Golf \$79.50; 1 Bally Bull. Tank Conv. \$49.50; 1 Rapid Fire, as is \$85. MARCUS KLEIN, 577 TENTH AVE., N. Y. N. Y.

FOR SALE—We can make immediate shipment of our famous exclusive new Plaskite casters for your phonos. Treat each phono on your route to a new set of these fine casters. Will not scratch hardwood floors. Price only \$1.50 per set of 4 casters complete with steel sockets. L. BERMAN & COMPANY, 112-114 N. W. FIRST STREET, EVANSVILLE 8, IND. Tel. 3-2734.

FOR SALE—Wurlitzer 800 with No. 130 Adaptor and 5 No. 100 Wall Boxes \$750.; Chicken Sam and Jail Bird \$100. ea.; Pitch Em and Catch Em \$125.; Mills 6 column Cigarette Machine \$50, 1/3 Deposit. MARTIN AND LYNWOOD SHIREY, 131 VALLEY ST., LEWISTOWN, PA.

FOR SALE — Big and small bulbs for coin operated machines; Wall Boxes; Games. Westinghouse Mazda or G.E. Mazda. Write. Lumilines. 12 and 13" long, clear, frosted or white. Fusetats; Fusetrons 12c ea. (100 to Pack); clearsite Plug fuses—3 amp. (approved) \$4.25 per 100. Send us your Tube, Bulb, Cable Wire needs. ARCADE BULB CO., 56 W. 25th ST., NEW YORK 10, N. Y. Tel: Watkins 9-7490

FOR SALE — Special! Rex Coin offers 1 50c Gold Chrome 2/5 P.O. A beautiful and mechanically perfect machine \$395. REX COIN MACHINE DISTRIBUTING CORP., 321-329 SOUTH SALINA ST., SYRACUSE 3, N. Y.

FOR SALE — 3 Keeney Submarines \$100. ea.; 2 Paces Races, brown cabinets, perfect condition \$125. ea.; 1 Bally Torpedo, very clean \$125.; 1 Pitchem and Catchem \$90.; 1 Whee Gee Mystic \$135.; 1 Bally Rapid Fire, very clean \$145. ASSOCIATED AMUSEMENTS, INC., 72 BROOKLINE AV., BOSTON 15, MASS. Tel: Commonwealth 0933

FOR SALE—Solovue Lamps \$2. ea.; #6SC7 Metal Tubes 90¢ ea., minimum order 15 tubes. 1/3 Deposit, balance C.O.D. GEORGE PONSER COMPANY, 713 SPRINGFIELD AVE., NEWARK, N. J.

FOR SALE — Reconditioned Seeburg Wall-O-Matic Wireless Boxes \$28.50; 3 wire boxes \$24.50; Rockola reconditioned Bar Boxes 5 wire \$19.50; Wall Boxes, late \$15.; Buckley Chrome 16, 20, 24's Wall Boxes \$22.50; Keeney Wall Boxes, late \$6. Other types available. Write or call your needs. E. T. MAPE, 1701 W. PICO BLVD., LOS ANGELES 15, CALIF. Tel: DRexel 2341

FOR SALE—25 Model 80 Kirk Astrology Scales \$169.50 ea. THE VENDING MACHINE CO., 205-215 FRANKLIN ST., FAYETTEVILLE, N. C. Tel.: 3171.

FOR SALE — 2 Evans Super Bombers \$240. ea.; 1 Horoscope \$90.; 1 Pitchem & Catchem (Floor Model) \$75.; 1 Air Raider \$120.; 2 Photomats (4x25) \$500. ea.; 1 Photomaton (3x50) \$500.; 1 Cupid Wheel \$90.; 25 lbs. Roovers Name Plate Tape \$1.50 lb.; 10 rolls 1½" x 1000' Direx Positive Paper, Nov. 1945 dating \$10. per roll. PEERLESS VENDING MACHINE CO., 220 W. 42nd ST., N. Y. 18, N. Y. Tel: WI 7-6173

FOR SALE—Arcade Equipment. Lost Lease and must sell. Make offer all or any part. Bally Defender; Chicken Sam Con.; Keeney Submarine; Bally Torpedo; Exhibit Ride-A-Bike; Shoot Your Way to Tokio. All perfect condition. GENTRY MUSIC & SALES CO., ALAMOGORDO, N. MEX.

FOR SALE — 15,000 Good used records 8c ea. Cash with deposit. BIRMINGHAM VENDING CO., 2117 THIRD AVE. NO., BIRMINGHAM, ALA.

FOR SALE—Postage Stamp Vending Machine Folders 39¢ per 1000, when ordered in multiples of 25,000. New low price. THE TRANSWESTERN CO., 742 MARKET ST., SAN FRANCISCO, CAL. Tel. EXbrook 4351.

FOR SALE — Spot Pool \$70.; Paradise \$55.; School Days \$55.; Entry \$40.; Band Wagon \$50.; Fox Hunt \$50.; Silver Skates \$50. All machines have rails and legs refinished and are ready for location. WANT — Wurlitzer Hideaways, CHECKER AMUSEMENT CO., 733 6th AVE., HUNTINGTON, W. VA.

THE CASH BOX

COIN MACHINE MART

CLASSIFIED ADVERTISING SECTION

FOR SALE

(Continued)

FOR SALE — Mills Four Bells, almost new, in storage 3 years, \$425.; Mills 10c QT like new \$75. NOTICE — We will rebuild Blue Fronts into Black Cherries, new reels, cabinets, castings, all worn parts replaced, choice of payout \$100. CENTURY INDUSTRIES, 2013 4th AVE., SEATTLE 1, WASH.

FOR SALE—Wurlitzer P12 \$135.; 412 \$165.; 616 \$249.; Seeburg Major \$425.; Envoy RC \$525.; 8800 \$595.; Boxes: Seeburg 5c Wireless \$32.50; Buckley (late model) \$15.; Skee Barrel Roll F.P. & K. like new \$229.; Scientific Batting Practice \$59.; Mutoscope 5 reel Selector \$179.; complete A.B.T. 6 Gun Shooting Gallery \$1900.; Gall. Dominos, br. cab. \$64. AMERICAN VENDING CO., 810 5th ST., MIAMI BEACH, FLA. Tel 58-1619.

FOR SALE — 1 Genco Cadillac \$32.50; 1 Bally Reserve \$30.; 1 Red White & Blue \$34.50; 1 Bally Triumph \$35.; 20 Pipe Stands \$3. ea. 1/3 Deposit. HUTZLER VENDING MACHINE CO., 900 WINCHESTER AVE., MARTINSBURG, W. VA. Tel: 1291

FOR SALE—Phonographs; Pin Tables Arcade Equipment. DONALD FIELDING & COMPANY (Lloyd Flaubert, Manager), 4356 ST LAWRENCE ST., MONTREAL, P. Q., CAN.

FOR SALE — 2 Streamliners \$185. ea.; 1 Oklahoma \$185.; 1 Short Stop (plastic bumpers) \$35; 1 Chicago Coin Hockey \$160.; 1 Victorious 1943 \$50. B. & O. AMUSEMENT CO., 120 SO. AUSTIN ST., SAN MARCOS, TEXAS

FOR SALE—The most complete parts stock on the West Coast for games and phonos. Visit our "See-At-A-Glance" parts department. JACK R. MOORE COMPANY, 100 ELLIOTT AVENUE, WEST SEATTLE 99, WASH.

FOR SALE—Here is a real buy. Steel hand trucks, rubber wheels, limited supply \$9.95 each. BAUM DISTRIBUTING COMPANY, 2713 GRAVOIS AVENUE, ST. LOUIS 18, MO. Tel. Prospect 3900.

FOR SALE — 1 1940 Super Rockola; 1 600R Wurlitzer; 1 Seeburg Gem; 6 pinball games. All machines in perfect condition. One Rockola remote box. X-CEL NOVELTY CO., 5240 N. 11th ST., PHILADELPHIA 41, PA. Tel: MIC. 2624

FOR SALE—\$25.00 and up Mills, Jennings, Watling Slots in 5-10-25¢ A-1 operating condition; 5 Ball Free Plays; 1-ball P. O. games Mills Panoram \$325. Send for list. MITCHELL NOVELTY CO., 1629 WEST MITCHELL ST., MILWAUKEE 4, WISC. Tel. Mitchell 3254.

FOR SALE—1000 hole Jack Pot Charlie money boards; 30 hole jack pot 25¢ play \$1.25 ea.; Universals, Red, White & Blue jar deals 2040 count, six \$3.00 winners each deal. \$20. per dozen bags. ANTHONY HIRT, 2393 NO. 11th STREET, SHEBOYGAN, WISC.

FOR SALE — New 30 wire Cable 500 & 1000 ft. Reels 19c ft.; new 2 wire Zip Cord 250 ft. coils \$4.75; Maple Skeeballs 3 1/2" and 2 3/4" sizes 55c ea., lots of 100 \$52. BLOCK MARBLE CO., 1527 FAIRMOUNT AVE., PHILADELPHIA 30, PA.

FOR SALE—Rock-Ola Commando \$625.; 3 Standard \$400. ea.; 4 De Luxe \$425. ea.; 2 Seeburg 8800 \$625. ea.; 1 Model K-20 record \$325.; 1 Mills Throne \$325.; 1 Wurlitzer 42/24 \$495.; 1 Wurlitzer 42/600 \$495.; 3 Wurlitzer 42/616 \$450. ea.; 1 Wurlitzer Counter 51 \$150. BLACKWELL MUSIC CO., 123 ELK AVE., ROCK HILL, S. C. Tel. 238.

FOR SALE — Mills Four Bells 4-5c \$325.; Mills 25c Jumbo C.P. \$199.50; 5c Free Play Jumbo \$89.50; Special Miami Beach \$59.50; Gun Club \$57.50, 2 pin games for \$100.; New Phono Casters with Bushings, large size, Hard Rubber Wheels to fit any phono Sample Set \$1.50; request quantity prices. WANT — Hidaway phonos with adapters. COLEMAN NOVELTY CO., 1023-25 FIFTH AVE., ROCKFORD, ILL. Tel: Main 1323

FOR SALE—Consoles, Bally one-balls F.P. jackpot models; original Jennings Slots 50c and \$1.; Mills Original Gold Chromes 5c, 10c, 25c. All types of equipment. Write H. ROSENBERG CO., 625 TENTH AVE., NEW YORK 19, N. Y. Tel.: Longacre 3-2479.

FOR SALE—NICKEL NUDGERS — perfect working condition \$1.95 ea. COLUMBIA MUSIC CO., 1514 N.E. 33rd AVE., PORTLAND 13, OREGON. Tel. Trinity 5592.
FOR SALE—Keeney 2-Way Superbell 5c/5c CP \$325.; Keeney 2-Way Superbell 5c/25c CP \$375.; Smoker Bells 550. AUTOMATIC MUSIC CO., 425 NO. 13th ST., TERRE HAUTE, IND. Tel. Crawford 2246.

FOR SALE — Original Jar O'Do Dangling Duckets Bingo Tickets 1000 on stick \$1. ea. in lots of 12; Grab A Fin Deals \$2. ea. in lots of 12; Poker Bok tickets 2160 in bag \$2.25 ea. in lots of 12. All types of Jar Deals (WRITE). A. E. CONDON SALES CO., 1424 MAIN ST., LEWISTON, IDAHO

FOR SALE — Pin Ball Machines: All American \$49.50; Four Roses \$49.50; Fox Hunt \$30.; Sea Hawk \$40. Machines are in perfect condition. DUFF'S RECORD SHOP, 24 E. PICADILLY ST., WINCHESTER, VA.

FOR SALE—All Steel Frame Hand Trucks, solid rubber large balloon tires, 2.75 by 10 inch roller bearings. All models and sizes. Pamphlets free. After 10 days trial if not satisfied, all money refunded. CHARLES PITTLE & COMPANY, 79 BEETLE ST., NEW BEDFORD, MASS. Tel. 2-3474.

FOR SALE—BATTING PRACTICE in good condition \$119.50; 9 ft. SUPREME SKEE BALL in good condition \$195.; SKEE BARREL ROLL—used but in excellent condition \$329.50; KEENEY AIR RAIDER—completely re-painted and tuned up \$185. NATIONAL NOVELTY CO., 183 MERRICK ROAD, MERRICK, N. Y.

FOR SALE — LIVE - LIVE - LIVE - LIVE! BUMPER RINGS — SMALL, MEDIUM and LARGE. Send for our latest price list TODAY. Just off the press! COIN MACHINE SERVICE CO., 2307 N. WESTERN AVE., CHICAGO, ILL.

FOR SALE—ABT Rifle Range: Brand new 67 moving targets, 4 reconditioned rifles, 1 refinished like new counter, 1 large compressor, BB cart, ready to set up, all you need to top and sides. Will sell or trade. What have you? PLAYLAND AMUSEMENTS CO., 220 N. WASHINGTON, LANSING, MICH.

FOR SALE—Seeburg Chicken Sams Converted: 3 to Rifle Range, 2 to Shoot The Jap, 1 to Shoot The Tank repainted. One Rifle Range is repainted. The M/c are all in good order and some are still on locations. \$85. ea. GIOMI BROS., 216 N. 3rd ST., ALBUQUERQUE, N. M.

FOR SALE—Twin Twelve and Twenty-Four Buckley accessories or adaptors; Buckley Wall Boxes 1942 Lightups and cable for same. AMERICAN NOVELTY COMPANY, 3155-61 GRAND RIVER AVENUE, DETROIT, MICHIGAN.

FOR SALE—Mutoscope Lightup Card Vendors in excellent condition \$27.50 each. FUNDLAND, INC., 740 GRANBY STREET, NORFOLK, VA.

FOR SALE—WIRE LINED MONEY BAGS. Solid leather, canvas, with wire mesh interlining, hand sewed, made for heavy duty, double handles, reinforced leather corners, straps around the sides & bottom, solid brass catches & lock with key. No. 203, size 14 in. \$33.50; No. 203, 16 in. \$37.50; No. 203, 18 in. \$40.50; No. 203, 20 in. \$44.50. ABBOTT COIN COUNTER CO., 143rd ST. & WALES AVE., NEW YORK 54, N. Y.

FOR SALE—Wurlitzer Pick-up Coils, all models, guaranteed perfect. Supply limited. Exclusive Rock-Ola distributors for Florida and South Georgia. SOUTHERN MUSIC COMPANY, 503 W. CENTRAL AVENUE, ORLANDO, FLA.

FOR SALE—Postage Stamp Machine Folders: 10M \$4.85; 25M \$11.75; 100M \$43.50; 500M \$200.; Shipman duplex model postage stamp machines \$24.50 each. WANT—We buy postage machines. State make, Price. PARKWAY MACHINE COMPANY, 3046-V TIOGA PARKWAY, BALTIMORE 15, MD.

FOR SALE — 1 Hamilton LoBoy (white enamel) Scale \$32.50; 1 Mills Owl \$27.50; 1 1c Cigarette vender, good as new, only \$5. DARLINGTON MUSIC CO., P. O. BOX 238, DARLINGTON, S. C.

FOR SALE—2 Victorious, conversion from Turf Champ; 2 Galloping Dominoes \$110. ea.; 2 Rapid Fires \$110. ea.; 1 Sport King, ready for location \$150.; 2 Multiple Racers \$35. ea.; parts for Mills Phonos; Panoram; pin tables and arcade equipment. OWL MINT MACHINE CO., 245 COLUMBUS AVE., BOSTON 16, MASS. Tel.: KENmore 2640.

FOR SALE—For best prices on all types of salesboards, both money salesboards and plain heading boards in all sizes. Write: A. N. S. COMPANY, 312 CARROLL ST., ELMIRA, N. Y.

FOR SALE—Universal Amplifiers, Standard model fits Wurlitzer, Rock-Ola Seeburg, Mills \$54.50; DeLuxe Model Fits Wurlitzer, Rock-Ola Mills and Seeburg Remote. Extra volume, superb tone \$69.50. HASTINGS DISTRIBUTING COMPANY, 2014 WEST VLIET STREET, MILWAUKEE 5, WISC.

FOR SALE—Vacation \$25.; Sara Suzy \$25.; O'Boy \$25.; Anabel \$25.; Score Card \$25.; Cowboy \$25.; Armada \$25.; Congo \$25.; Daily Dozen \$25.; Defense, Baker \$25.; Snack the Japs \$35.; Kentucky P.O. \$200.; Sport King P.O. \$150.; 2 9 ft. Bowl A Bomb \$150. ea.; 1 9 ft. Bowling League \$150.; 1 Midget Skee Ball \$75. CENTRAL COIN MACHINE CO., 482 CENTRAL AVE., ROCHESTER, N. Y. Tel. Main 5973.

FOR SALE—3 Wur. 120 Wall Boxes, metal covers \$24.50 ea.; 20 Buckley Chrome 24's \$19.50 ea.; Rock-Ola 5c Bar Boxes & Wall Boxes \$17.50; Wur. 100 Wall Boxes \$15.; A.M.I. Streamliners \$275.; Singing Towers \$325.; A.M.I. Conc. unit with 1 bar box, 2 wall boxes, speaker & cable \$275.; 2 Seeburg Sportsmen \$75. ea.; Wur. 850 \$795.; G. N. VENDING CO., 663 W. BROAD, COLUMBUS 8, OHIO.

FOR SALE—Crystal Pickups. Immediate delivery of Astatic Crystal Pickups. No. L-22 A or B-2 \$3.00 each, \$33.00 per dozen. HARRY MARCUS COMPANY, 816 WEST EHIE STREET, CHICAGO 22, ILL.

FOR SALE—Kicker & Catcher \$19.50; A.B.T. Targets \$12.; Bally Basketball \$89.50; 10 Mills Cigarette Machines \$22.50 ea., lot \$175.; Poker & Joker \$69.50; Seeburg Target Conv. \$95.; Keeney Air Raider \$139.50; Bally Rapid Fire \$145.; Tail Gunner \$95.; Buckley Electric Hoist \$59.50; Scientific Batting Practice \$105.; Liberators \$175. THE MARKEPP CO., 4310 CARNEGIE AVE., CLEVELAND 3, OHIO. Tel. Henderson 1043.

FOR SALE—Ready for Delivery! SMILEY, sensational 5-ball Counter Game. \$39.50. Order Today! BUBBLE, 5-ball Revamp Pin Game. Write. LEON TAKSEN CO., 2035 GERMANTOWN AVE., PHILADELPHIA 22, PA. Tel. Poplar 3638.

FOR SALE—We have available Fruit Reel Top Glasses for Bally Big Top, 2-4 and 3-5 payout \$10.00 each or \$84.00 in dozen lots. MECHANIC'S SERVICE, 2124 FIFTH AVE., PITTSBURGH 19, PA. Tel. Atlantic 0662.

FOR SALE—Brown Cherry Front Castings \$19.50; Universal Amplifiers A & B Models, Model A \$49.50, Model B fits all incl. Hi Tone \$69.50; Hand trucks, rubber tires \$9.95; Phonograph casters, set of 4 \$1.45; Record Carrying Cases \$5.95; Coin Wrapper 65c per box, 10 boxes or more 60c ea. Case of 28 boxes 55c ea. BADGER NOVELTY CO., 2546 N. 30th ST., MILWAUKEE 10, WIS.

FOR SALE—3 Bally Club Bells F.P. \$219.50 ea.; 3 Bally Sun Rays F.P., very clean \$169.50 ea.; Mills Vest Pockets B & G \$37.50; Columbia Bells GA \$37.50; 25c Enameled J.P. Caille \$49.50; Keeney Skylark \$125.; Contest \$85.; 7 1/2 ft. Roll-A-Balls, brand new \$225.; Used, but A-1 condition \$155. Rotary Merchandisers. Write. KENTUCKY AMUSEMENT CO., 919 W. JEFFERSON ST., LOUISVILLE, KY. Tel. Ja 4636.

MISCELLANEOUS

NOTICE — Phono Needles Re-Sharpener. Continual Growth of a business means satisfied customers. The number of our satisfied customers has grown steadily during the past four and one-half years. Send us your used needles for RE-SHARPENING. You will be satisfied too. RE-SHARP NEEDLE SERVICE, P. O. BOX 770, FT. DODGE, IOWA

NOTICE—Want to get in touch with coin machine manufacturers for wholesale distributorship of coin machines, any type, for Eastern Canada, the Maritime Provinces. Send information to L. A. Reid, REID AMUSEMENT MACHINES, 280 BOTSFORD STREET, MONCTON, N. B., CAN.

NOTICE—I will buy and sell Music, Arcade, Candy Machines. What have you? What do you need? STATE VENDING COMPANY, 300 HARRISON AVE., BOSTON 18, MASS.

NOTICE—Canadian Operators! We are now distributors in Eastern Canada for the famous Packard Pla-Mor Phonographs and complete line of accessories featuring featuring for immediate delivery Pla-Mor 30-wire Wal Boxes and cable. Get on our mailing list now. LAWRENCE NOVELTY, 1436 NOTRE DAME ST., W. MONTREAL, QUE.

NOTICE—Write for our list of True Value Buys, Slots, Pins, Consoles, Music, Arcade. LEADER SALES COMPANY, 131-133 FIFTH STREET, READING, PA.

NOTICE—Speed that's us. 1 hour Amplifier service; 1 hour tone arm service. We re-cone speakers. Reasonable prices. All work fully guaranteed. DEE'S SERVICE SHOP, 1119 VENICE BOULEVARD, LOS ANGELES 15, CALIF. Tel. FE 7875.

NOTICE — Two day service on starter windings of Phonograph Motors. Wurlitzer, Seeburg & Rockola \$5., all others \$6.50. Complete rebuilding of motors at extra charge. BRADY DISTRIBUTING CO., 300 WEST THIRD ST., CHARLOTTE, N. C.

NOTICE—Record discs for 61, 71 and all other Wurlitzer Counter Models, reconditioned. I will make your old discs the same dimensions as when new and guarantee them to give satisfaction. Price \$7.50 per set of 12 or \$6.00 a set in lots of 5. HUGO JOERIS, 3208 JACKSON STREET, AMARILLO, TEXAS.

THE CASH BOX

COIN MACHINE MART

CLASSIFIED ADVERTISING SECTION

MISCELLANEOUS

(Continued)

NOTICE—You'll like to do business with Jack Rosenfeld. Exclusive Bally Distributor for Eastern Missouri, Southern Illinois, Western Kentucky. J. ROSENFELD CO., 3218 OLIVE STREET, ST. LOUIS 3, MO. Tel. NEWstead 1583.

NOTICE — Attention Operators! Sell us your used equipment and remember, if it's controlled with a coin we have it. Always first with the latest. Contact us for the better deal. C. M. McDANIEL DISTRIBUTING CO., 301 S. MAIN AVE., SAN ANTONIO 5, TEXAS. Tel: F-1335

NOTICE—The most complete stock on the West Coast—parts for phonos and games. Visit our "See-At-A-Glance" parts department. JACK R. MOORE COMPANY, 1615 S.W. 14th AVENUE, PORTLAND 1, ORE.

NOTICE — New England operators, when next in Boston visit our new showrooms. Excellent repair department. NEW AND USED EQUIPMENT FOR SALE. NEW ENGLANDEXHIBIT COMPANY, 1289 WASHINGTON STREET, BOSTON 18, MASS. Tel. Dev. 8381.

NOTICE—Complete phonograph repair service, amplifiers, motors, pickups and counter boxes. Used equipment bought and sold. Write or phone. NELS NELSON, 2329 WEST PICO BLVD., LOS ANGELES, CAL. Tel. Fltroy 0545.

NOTICE—We are organized for the best interest of the Coin Machine Operators of Los Angeles County. We will welcome any correspondence from any association in the country. ASSOCIATED OPERATORS OF LOS ANGELES COUNTY, INC., 1351 W. WASHINGTON BLVD., LOS ANGELES 7, CALIF.

NOTICE—Your old rectifiers rebuilt like new. Keep your games and phonos in A-1 operating condition. Rebuilt to give new unit performance and longevity. All makes, types and sizes rebuilt at \$2.50 each. Detach rectifiers from transformers. Transportation to us must be prepaid. All rebuilt units are returned COD plus transportation. BATES LABORATORIES, 571 HILL AVE., GLEN ELLYN, ILL.

NOTICE—Rock-Ola, Seeburg, Wurlitzer Motors rewound to factory specifications. Starter Windings \$5.; complete rewind \$10.; Mills Motors, Starter Windings \$6.50; complete rewind \$13. One day service. All work guaranteed. S & M SALES, 1074 UNION AVE., MEMPHIS, TENN. Tel.: 2-1133.

NOTICE—"A" Day has arrived in Wisconsin and all the coin machine activity is concentrated right here in Milwaukee because AIREON . . . the ELECTRONIC phonograph is NOW ON DISPLAY at KLEIN DISTRIBUTING CO., 2606 W. FOND DU LAC AVE., MILWAUKEE 6, WISC.

NOTICE—Protect and hold that location! We'll rebuild your old scales and make 'em look like new. (Est. 1889) WATLING MANUFACTURING COMPANY, 4650 WEST FULTON STREET, CHICAGO, ILL. Tel. COLUMBUS 2779.

NOTICE — JUKE BOX NEEDLES RE-SHARPENED. A good Clean Service that is DEPENDABLE — ECONOMICAL — GUARANTEED — HONEST. Wise music operators are all using it. Write for free shipping containers and details. RE-SHARP NEEDLE SERVICE, P.O. BOX 770, FORT DODGE, IOWA

PASS THIS SUBSCRIPTION ON TO A FRIEND!!

"THE CASH BOX"

"The Confidential Weekly of The Coin Machine Industry"

381 FOURTH AVENUE, NEW YORK 16, N. Y.

PLEASE ENTER MY SUBSCRIPTION FOR ONE YEAR. ENCLOSED FIND CHECK FOR

\$48.00 — FIRST CLASS MAILING, PLUS FREE WEEKLY CLASSIFIED AD PRIVILEGE

\$15.00 — FIRST CLASS MAIL ONLY

(ALL SUBSCRIPTIONS PAYABLE IN ADVANCE)

NAME

FIRM

STREET

CITY ZONE STATE

THE GREAT EAST

1914

CHAPTER I

THE GREAT EAST

THE GREAT EAST

THE GREAT EAST

THE GREAT EAST

THE GREAT EAST

THE GREAT EAST

THE GREAT EAST

THE GREAT EAST

THE GREAT EAST

THE GREAT EAST

THE GREAT EAST

THE GREAT EAST

THE GREAT EAST

Only **Aireon** has



Liquitone

The Ultimate in *Electronic* Tone Quality

AUTOMATIC VOLUME CONTROL

No blast or mumble, volume controlled by changing noise level in room, from pre-set normal.

NEW TONAL ARCH

Reproduces true tone, regardless of shape or size of room, or nature of walls and ceilings.

PARABOLIC SOUND DISTRIBUTION

Adjustable speaker setting "tailors" sound to shape and size of room, eliminates all dead spots.

RIM DRIVE TURNTABLE

Eliminates gear noises and motor hum.

MAGNESIUM PICK-UP HEAD

Minimizes record wear, improves tone.

MATCHING FREQUENCY

For range of today's records, eliminates extra sounds, scratches, etc.

SPECIAL SPEAKER

Aireon designed and built, 15-inch 12,000 cycle, carries maximum range of harmonics and tone.

What *one* feature of any coin-operated phonograph brings in the most nickels—pays off the biggest profits? It's the tone-quality, of course—because the folks who pay are buying *music*—and the music that pleases most is the music that pays best.

Only Aireon can give you Liquitone, that ultimate perfection in tone quality—because only Aireon, the *Electronic* Phonograph, has the features which automatically eliminate all blast or mumble, needle scratch and gear noises, "dead spots" and distortion—and sends through a specially designed speaker only the pure, liquid tones that were put on the record in recording.

For your best locations—where the customers want their music good and often, where you pick the best records for the biggest play, there's only one phonograph, from now on—

General Offices:

1401 Fairfax Trafficway, Kansas City, Kans.

General Sales Offices:

1233 Grand Avenue, Kansas City 6, Mo.

Aireon

MANUFACTURING
CORPORATION

Plants and Laboratories: Slater, Mo. • Los Gatos, Calif. • Oklahoma City
Mexico, D. F. • Kansas City • Greenwich, Conn. • Pasadena, Calif.

BY TOP MONEY MAKERS

Bally

FOR EVERY TYPE OF LOCATION

VICTORY DERBY

ONE BALL
MULTIPLE
PAY TABLE



NEW
DAILY
DOUBLE
INSURES BIG
REPEAT PLAY

Packed with all the profit-proved features of Bally's famous pre-war multiple games, VICTORY DERBY also introduces new play-stimulating ideas that are pushing profits to a new all-time high. Order today for early delivery.

VICTORY SPECIAL

ONE OR FIVE
BALL REPLAY
MULTIPLE



VICTORY DERBY
... and VICTORY
SPECIAL feature
Bally's new Finger-
Touch Shuffle and
new Slug-Rejector
drop-type coin-
chute. Simply drop
coins in cup-front
chute... then a slight
pressure on Shuffle
starts the play.

Bally's big beautiful VICTORY SPECIAL is your post-war profit insurance in replay territory. Quickly convertible to one or five ball play... and a fast money-maker either way. For top profits in replay spots order VICTORY SPECIAL today.

SURF QUEENS

NEW FIVE BALL
NOVELTY
GAME



NOVELT
OR
REPLAY
QUICKLY
CONVERTIBLE

Designed by a successful operator known for his ability to pick winners, SURF QUEENS is packed with all the time-tested features of a money-making game, plus angles that will bring the slowest spots to life in a hurry. Location tests definitely prove SURF QUEENS a winner in a class with Bumper, Bally Reserve and other famous Bally hits. Be first in your territory with SURF QUEENS—order today from your Bally distributor.



Bally MANUFACTURING COMPANY
DIVISION OF LION MANUFACTURING CORPORATION
2640 BELMONT AVENUE, CHICAGO 18, ILLINOIS