

# ACE

# MAGAZINE OF THE YEAR

■ ST ■ AMIGA ■ C64 ■  
CPC ■ SPECTRUM ■ PC  
■ NINTENDO ■ SEGA ■

## ADVANCED COMPUTER ENTERTAINMENT

### EXCLUSIVE FREE GIFT! THE ACE 64-PAGE DIARY FOR 1990

High score table...great games...essential telephone numbers...and much more in this essential guide to the coming year.

**Oi! Someone's nicked your diary**

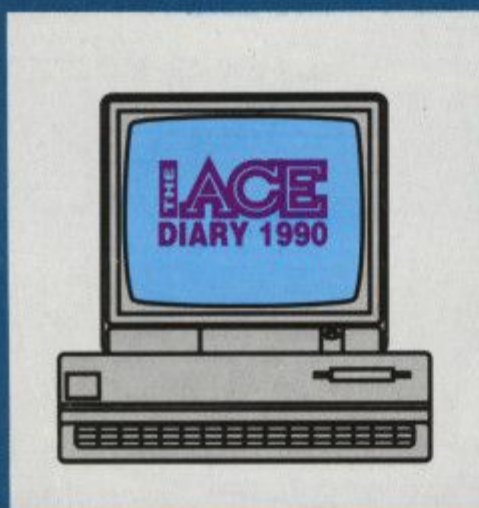

If your copy of The ACE Diary is missing when you purchase the magazine, ask your newsagent.



### ACE DECADENT ISSUE!



**THE DAWN OF COMPUTER ENTERTAINMENT**  
to the present day: 3-part guide to 10 years of gaming starts this issue...

#### OVER 60 GAMES

Reviewed and previewed, including *Hard Drivin'*, *It Came From The Desert*, and *Leisure Suit Larry III*.

**EXCLUSIVES!**



#### Battle of Britain

Lucasfilm reach for the skies

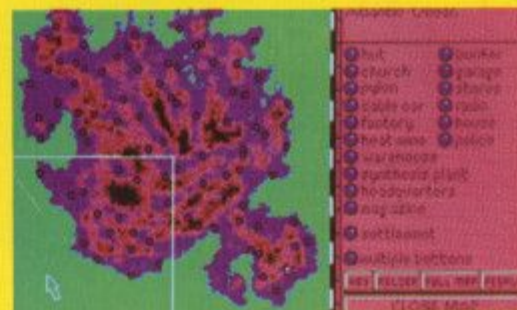

#### Midwinter

Mike Singleton's fractal-based Microprose masterpiece

### UPGRADING? SAVE £20!

£20 off your purchase of an Atari ST or Commodore Amiga with the ACE Upgrade Voucher.



# A UNIQUE COSMIC CONCEPT ...

AN  
A

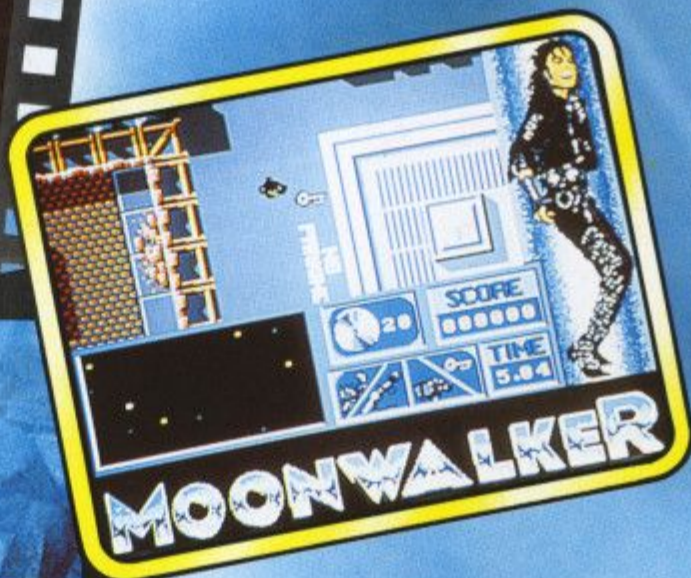
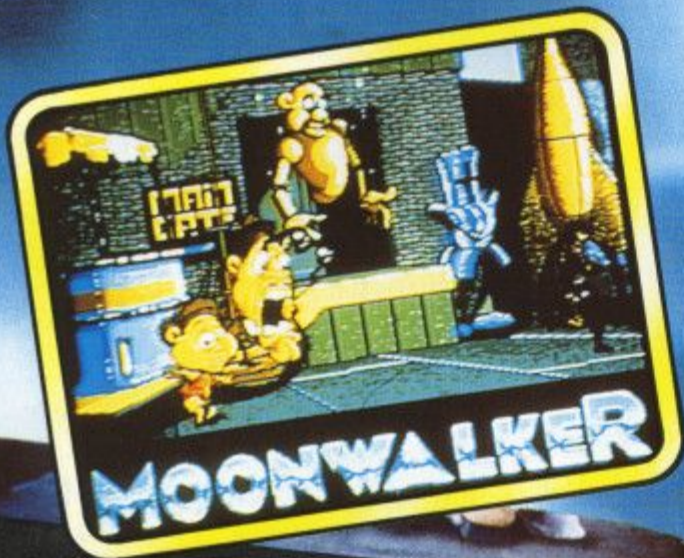

Screen shots from various systems.

© 1989 Triumph International, Inc. All Rights Reserved.  
© 1989 Keypunch Software, Inc. All Rights Reserved.



U.S. GOLD LTD., Units 2/3 Rollard Way,  
Rollard, Birmingham B6 7AQ. Tel: 021 628 3388

A m  
h  
h  
th  
fi  
h  
F  
in  
U  
N  
M  
C  
S



AN UNPARALLELED MOVIE EXPERIENCE...  
AN UNBELIEVABLE COMPUTER REALITY.

# MICHAEL JACKSON MOONWALKER™



After conquering the world of pop music, Michael Jackson channelled his energy and talent into making his first film. Now U.S. Gold present the home computer version of that film, endorsed by the Superstar himself.

Feel the rhythm in Club 30, transform into a futuristic silver robot and ultimately beat the drug peddling MR BIG in the unique world of **MOONWALKER** – a game like no other.

CBM 64/128 & AMSTRAD Cassette & Disk.  
SPECTRUM 48/128K Cassette. ATARI ST.  
AMIGA. IBM P.C.

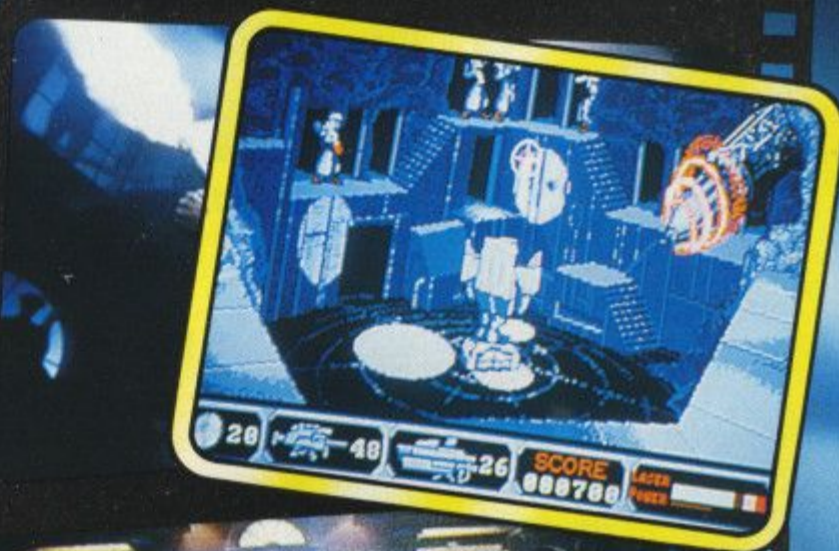
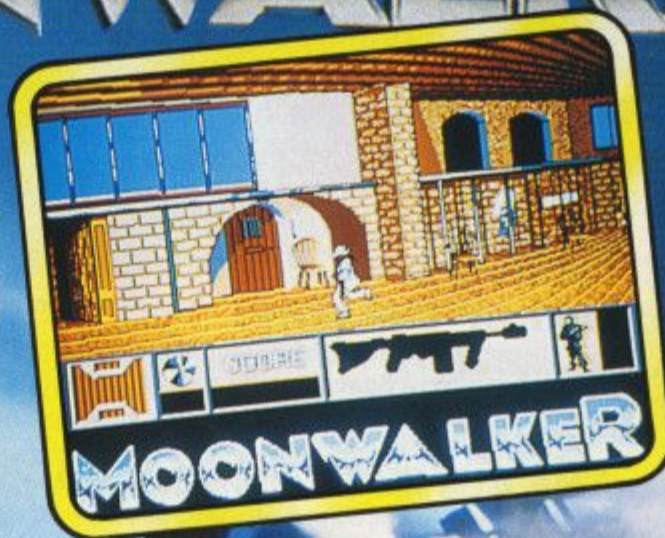





**EMAP B&CP**  
 Priory Court  
 30-32 Farringdon Lane  
 London EC1R 3AU  
 Tel: 01-251 6222  
 Fax: 01-490 0991

**Editor**  
 Steve Cooke

**Deputy Editor**  
 Rik Haynes

**Reviews Editor**  
 Laurence Scotford

**Design Editor**  
 Jim Willis

**Contributors**  
 Eugene Lacey  
 Kati Hamza  
 John Minson  
 John Cook  
 Gordon Houghton  
 Gary Whitta  
 Gary Penn  
 Ciaran Brennan  
 Mark Patterson  
 Phil South  
 Pat Winstanley  
 Christina Erskine

**Additional Design By**  
 Phil Hendy

**Illustration**  
 Geoff Fowler

**Advertising Manager**  
 Garry Williams

**Deputy Advertising Manager**  
 Jerry Hall

**Advertising Production**  
 Melanie Costin

**Publisher**  
 Terry Pratt

**SUBSCRIPTIONS**  
 EMAP Frontline, Subscriptions Dept.  
 1 Lincoln Court, Lincoln Road,  
 Peterborough, PE1 2RP  
 0733 555161

**COLOUR ORIGATION**  
 Latent Image, Balmoral Grove, N7  
 Balmoral Graphics, Canonbury Yd, N1  
 Proprint Repro, Stratford, E15

**TYPESETTING**  
 CXT, 74 Borough High Street, London,  
 SE1. 01-378 8139

**DISTRIBUTION**  
 EMAP Frontline, Park House, 117 Park  
 Road, Peterborough, PE1 2TR  
 0733 555161

**PRINTING**  
 Severn Valley Press, Caerphilly

© EMAP B&CP 1989  
 No part of this publication may be reproduced

## SPECIALS

### ACE FLASHBACK!.....31

We celebrate the **end of the decade** that launched home computer entertainment. This isn't just **history**, it's **myth and legend** – including such unforgettable trivia as the 1K micro advertised for **running a nuclear power station!**

### DEATH CHAMBER.....120

A **steel womb**, a **vibrating control panel**, and sixteen terrified gamers locked in **mortal combat**. Is the Battletech Centre the **end of life** as we know it?



Flight paused. Press any key to continue.

### OUT OF THE SUN.....39

ACE checks out the **Battle of Britain Simulator**: more flight options than a **Space Shuttle** and light years beyond Biggles.

### THE BIG CHILL.....104

Humanity faces **extinction**...Polar bears **die of cold**...We plunge into **Midwinter**, Rainbird's most ambitious game to date, and discover a 20-million triangle, fractal-generated **hell on earth**.

### GOLDCUT GAMES.....27

On a cold and grey November morn, two members of the ACE team crept **out of the ghetto** and visited...**Birmingham**. They returned with news of startling software developments from the UK's **program powerhouse**: US Gold.

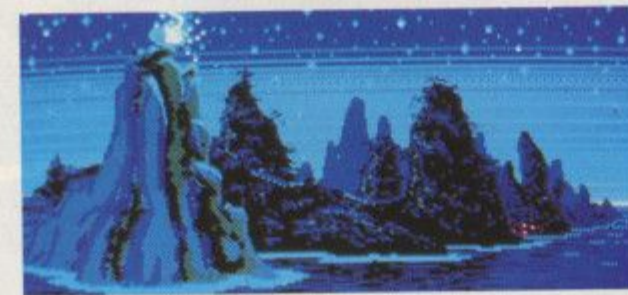

### BEYOND WORDS.....126

ACE readers put their **souls on screen** in pixel prose. Could you do better? **Prove it...**

# SPITFIRE FURY...

Not content with producing a Battle of Britain game, Lucasfilms have stormed ahead and put out a full-blooded Battle of Britain simulator. Not only can you fly dozens of British and German planes, but you can also plan your Battle of Britain strategy – see pages 39-41.

## GAMES GALORE!

ACE is overflowing with games news again...In addition to the full reviews listed below, you'll find coverage of the latest conversions on pages 123/124; our guide to over 60 top games in the Pink Pages (starting on p.137) – ideal for Christmas presents (for yourself, of course), plus three new fantasy/RPG's on pp.109/110.

BATTLE SQUADRON .....	56
European Electronic Zoo	
BRUCE LEE Mindscape.....	49
BUSHIDO Firebird .....	79
CLOWNOMANIA Starbyte .....	100
DRAGON SPIRIT Tengen .....	73
DRAKKHEN Infogrames .....	95
FUTURE WARS Palace/Delphine.....	55
GALAXY FORCE Activision .....	91
GHOSTBUSTERS Sega.....	50
GHOSTBUSTERS II Activision .....	88
GHOULS'N'GHOSTS US Gold .....	68
HARD DRIVIN' Domark .....	46
INTERDICTOR Clares.....	84
IT CAME FROM THE DESERT.....	87
Cinemaware	
LEISURE SUIT LARRY III .....	61
Sierra On-Line	
MOONWALKER U.S. Gold.....	70
MYTH System 3 .....	62
ONSLAUGHT Hewson.....	52
QUARTZ Firebird.....	92
RALLY CROSS Anco .....	80
ROLLER COASTER Tynesoft .....	74
SNARE Thalamus .....	99
SWITCHBLADE Gremlin .....	51
THE CYCLES Accolade.....	97
THE THIRD COURIER Accolade .....	58
TOOBIN' Tengen.....	72
TURBO OUTFUN U.S. Gold .....	65
TWIN WORLDS Ubisoft.....	77
WONDER BOY III Sega.....	50

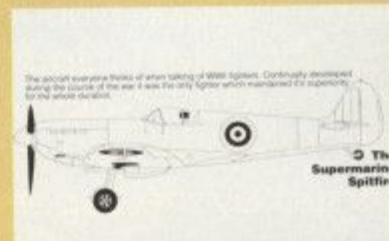

ACE's resident aircraft expert reveals the principles of flight in on page 40.

# £20 OFF!

Want an ST or an Amiga for Christmas? Save £20 with an ACE



# END OF AN ERA

**It fair made us weep, guv. As the ACE Team travelled back over the last ten years for our pilgrimage through the decade, even the iron-spirited Rik Haynes was seen to shed a private tear. Farewell Eugene Evans, programmer of the immortal Whacky Waiters, now lost down the brain drain (surely some mistake – it was a terrible game) to the USA; farewell the Microdrive ("...it will have a major impact for sophisticated personal/business software..."); and where do Space Intruders intrude now (probably at number one in some far Eastern country). It's all there, in a giant three part series starting this month. However, when we actually got down to playing some of the Great Old Games, we got a bit of a shock. A few flickering sprites jerked across the screen, something beeped, and then we got ERROR IN LINE 40059. We soon dried our tears: gameplay may be what it's all about, but give us gameplay AND solid-3D state-of-the-art displays (with digitised stereo sound) any day.**

## GAMEPLAY

### SCREEN TEST .....44

The glowing games heart of Christmas features the rigours of *Hard Drivin'*, the terrors of *Ghouls'n'Ghosts*, the fists of Bruce Lee, the screams of *It Came From The Desert*, the lechery of *Leisure Suit Larry III...No Santas* – but you do get a Mickey in *Moonwalker*.



### IN ARCADIA .....14

Coin-op futures: will *Block Hole* be bigger than *Tetris*?

### BIG BANG! .....23

The ACE Stockmarket continues with this month's charts as software houses suffer the slings and arrows of outrageous fortune in the games world.

### DIAL 999! .....113

You're in a jam: turn now to the ACE Tricks and Tactics section. Hints and maps for *Shadow of the Beast*, *Spy Vs. Spy II* on the Sega, *Xenon II* tips, and more...

## WIN! WIN! WIN!

### PINK PRIZES .....161

Yie ar keee-ough ch-i-ow Waaaa! Grab yourself a video of Bruce Lee in action, courtesy of Mindscape.

### ACE VOUCHERS .....151

Grab your vouchers and save £20 off your Christmas upgrade present. 16-bit owners get a go next month.

## REGULARS

### NEWS.....9

After all the fuss over the Nintendo Gameboy, we hear news of a colour model...plus news of the stimulator – a new form of simulator that really kicks ass. A report too on the outcome of the historic *Tetris* legal battle between Nintendo and Tengen.

### LETTER BOMBS .....17

ACE readers explode a few preconceptions. Join them – you could win a prize, and a reputation.

### FREE ISSUE! .....42

ACE is here, now. The future is far away. Bridge the gap with a subscription for Britain's most respected entertainment technology magazine – and get a free issue into the bargain.

## NEXT MONTH

### \$6000 A SECOND

Some sprites are cute; some sprites are vicious; but this man's sprites won an Oscar! ACE profiles John Lasseter, a man who can move mountains – on screen.



'Knickknack' ©1989 Pixar

### WAR!

ACE carries the industry's first in-depth report into the psychology, challenge, and achievements of computer wargaming. Will the final battle be between men...or sprites?

# UPGRADE NOW!

Christmas upgrade voucher. And 16-bit owners get their own upgrade discounts on p151.



# THE FASTEST, MOST THRILLING, 3D DRIVING GAME YET!

Take the wheel of your turbo-charged Porsche as you and your partner go in pursuit of dangerous criminals all driving an evil array of souped-up roadsters.

# TURBO BOOST!

Need to catch up in a hurry? Well, just one press of your Turbo Button will leave your eyes in the back of your head!

# BARRELLING THROUGH THE CITY STREETS,

along the roughest of dirt tracks and through busy tunnels – if you can hold the line! The low life can run, but they can't hide ... **CHASE H.Q.**



AMSTRAD  
**£9.99**  
COMMODORE

SPECTRUM  
**£9.99**  
SPECTRUM

ATARI ST  
**£19.99**  
ATARI ST

AMIGA  
**£24.99**  
AMIGA





V O T E D

# ARCADE GAME OF THE YEAR

**Ocean**®

HIGH SCORE	1933747	LIFE	21	DISTANCE	10"
SCORE	3907879				





# Hard Drivin'

A TRUE THREE-DIMENSIONAL WORLD  
PRESENTED ON THE SCREEN!



EXCITING STUNT TRACK  
WITH A 360-DEGREE LOOP!



QUALIFY AND CHALLENGE  
THE TOP HARD DRIVER!



## THE ULTIMATE DRIVING SIMULATOR

— that leaves all other driving games behind!

How would you like to test drive a high powered sports car on a stunt course? Have you ever jumped a draw bridge or driven a loop-the-loop? Now's your chance!

Or maybe high-speed driving is your idea of excitement. Step on the gas and try to keep control while skidding round the corners, weave in and out of the traffic and avoid oncoming cars!

Hard Drivin', available for your home computer, is not just the best game on offer — it's a whole new driving experience.

Take Hard Drivin' for a test drive today!



© 1989 Tengen Inc. All rights reserved.  
by Atari Games Corporation  
Programmed by Jürgen Friedrich 16-bit Binary Design 8-bit

## TENGEN

The Name in Coin-Op Conversions.

Domark Ltd, Ferry House, 51-57 Lacy Road, London  
SW15 1PR Tel: 01-780 2222

IBM PC · Amiga · Atari ST · Commodore 64 · Amstrad · Spectrum

# DOMARK



- Colour Nintendo Gameboy?
- Rent yourself a console
- Codemasters go on CD...

# ACE NEWS

## GAMEBOY II

Just when you thought it was safe to start saving up for an Atari colour Lynx console, news comes from the East of a new Nintendo....

**N**intendo is planning to launch a full colour version of its highly successful monochrome Gameboy, according to a number of unofficial sources. Its current monochrome Gameboy hand-held system is doing a storm in Japan and USA with demand easily outstripping supply (see ACE 27).

Meanwhile Gameboy is set for a UK debut at the Earls Court Toy Fair in January – along with its rival Atari Lynx colour hand-held console. Some cynics say Nintendo will wait several months before officially disclosing a colour Gameboy – thus allowing them to soak up the

profits from its phenomenally successful mono deck. As ACE went to press Nintendo was unavailable for comment.

Meanwhile, Nintendo has just won its long-going court battle with Tengen over the classic *Tetris*. Nintendo now has exclusive rights to this addictive game – after some confusion over what company had what rights from whom. Although this Nintendo vs Tengen court battle is over, there is still another \$100 million lawsuit between the two companies – this time over alleged patent infringement. The final judgment in this case will be in the New Year.



## STIMULATING!

A Californian entrepreneur has developed a revolutionary new like-like entertainment race-car simulator. Developed by Driver Seat, the Stimulator is an amusement-park ride similar to Walt Disney's Theatre-Simulator (as featured in ACE 27). Based around a Formula One racing car, the Stimulator is a fully-enclosed motion capsule – a scaled-down version of the many civil and military flight-simulators – which can move at 25 revolutions per minute. In fact, the Stimulators are built by Environmental Technics for training Navy Pilots. US gamers can look forward to experiencing a Stimulator later in the year at their local shopping mall or amusement park – as for their UK counterparts we'll have to wait and see...



Walt Disney's *Body Wars* theatre-simulator in full swing

## SEGA FOR RENT

Virgin/Mastertronic has hit upon another great marketing scheme to promote its Sega Master console – its going to let you rent (or buy) Sega's from your local video rental shop.

Under the scheme, you can go into any RCA/Columbia outlet (there are some 1200 around the UK) and rent out a Sega console or games cartridge. Although market forces will decide the eventual asking price, a rough price guide would be £10 per weekend for the console (with a few games thrown in) and £2 per night for a game (from a selection of twenty top titles). On the subject of the Sega's rental durability, Philip Ley – Sega Brand Manager at Virgin/Mastertronic – told ACE: "we're lucky the Sega's so bullet proof".

## SHOP TILL 'YER DROP

Computer City Supercentre – the world's first computer supermarket – opened to a rapturous computer public last month in Garden Grove, California. As well as demonstrations of the latest hard and soft wares there is a software lab for testing programs. The normal assortment of box-shifters are supplemented by manufacturers such as Apple, IBM and Epson. The next Supercentre will open in San Diego, and Computer City plans to open 20 US stores over the next five years. Unfortunately a UK Supercentre doesn't look very likely, but you never know...





Bros. on CD... Darling Bros. that is!

## COMPACT CODE MASTERS

Veteran budgeteers Code Masters has come up with a novel way to sell a games compilation... by releasing it on Compact Disk for Spectrum, C64 and CPC.

The £20 30-game compilation (including Code Masters "classics" like *BMX Simulator*, *Fruit Machine Simulator* and *Four Soccer Simulators*) comes on a CD and leads to connect to a CD player. Code Masters claims its CD will work with 99% of players, with an average load time of just 20 seconds. German software developer, Rainbow Arts already has a similar CD package for the C64 – though the Arts pack only includes six games and costs £30. Amiga, ST and PC owners will have to wait for their CM CD games due to "technical difficulties". Funnily enough, Code Masters aren't calling the pack, *CD Simulator!*

## BUDDING BUDO

Electronic Arts' latest PC release is a epic martial arts game with a multitude of opponents and disciplines to master. The most startling thing about the *Budokan* is its beautiful graphics and wonderful sound: the picturesque backdrops are complemented by life-like sprites and nice little animated touches like flying birds and waterfalls. Even the sampled sound effects through the internal speaker are impressive. As with many EA PC titles, the full complement of graphics modes and sound boards are catered for. ACE has played an preproduction version of the game, and it not only looks and sounds good but also plays extremely well – check out next month's issue for a full review. PC *Budokan* costs £24.99 and should be available now – other versions may follow later in the year.

## NO SEXIST SOFTWARE

OASIS (Organisation Against Sexism in Software) recently celebrated its first anniversary. Sandra Vogel, founder of the organisation and keen ST gamester, decided to campaign against sexist software after playing one offensive game too many. Vogel says, "I can see no reason why stereotypes of women (or men) should have to be used in computer games. One of the advantages this technology has over other games media is that you can do literally anything with a computer".

Membership to OASIS costs £3 (£5 overseas). Members receive six magazines a year, lists of recommended software and names of useful organisations. If you're interested make cheques payable to Sandra Vogel or send an SAE to: Sandra Vogel, 3 Alden Court, Stanley Road, Wimbledon, London SW19 8RD.

## NEWS FROM USA

- *The Wizard* movie from Universal Pictures – starring Fred Savage from the cult Channel Four Sunday evening comedy *The Wonder Years* – tells the adventures of two brothers at the National Video Game Championships. It opened across America on 15th November, it should be over here during 1990.

- Taito America has bought up the rights to *Indiana Jones: The Last Crusade* from Lucasfilm Games. The game should be appearing in coin-op form sometime this year. Previously, Atari Games handled the coin-op conversion of Lucasfilm's *Indiana Jones and the Temple of Doom*.

- Cinemaware games are to be converted over to Nintendo NES. No title details at present, but *Defender of the Crown* is sure to be among the conversions planned.

## IN THE PIPELINE

Entertainment International is so pleased with its latest game that it's licensed the title out to leading US software company Lucasfilm and is planning coin-op, console and hand-held versions. With a provisional title of *Pipe Dream*, the game was originally created by John Dale at the Assembly Line, but once Lucasfilm got involved with the project, it underwent some tweaks in the looks and playability departments. *Pipe Dream* is one of those simple, but infuriatingly addictive, arcade/puzzle games like *Tetris* or *Xor*. Expect to see it sometime in January on Spectrum, C64, CPC, ST, Amiga,

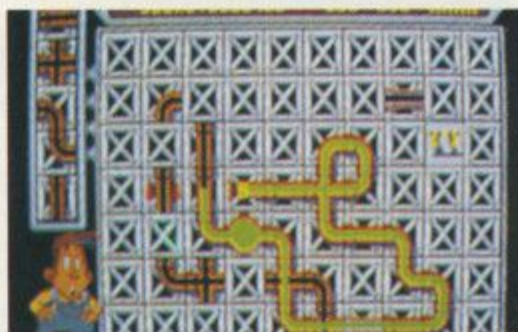

Eat your heart out, Bruce Lee!



# HARD DRIVEN'

ACE INTERVIEWS THE GUYS BEHIND DOMARK'S 937-RATED RACER

Jürgen Friedrich and Mike Day are the programmers behind the ST and Spectrum versions of *Hard Drivin'* (reviewed on pages 46/47). Spectrum *Hard Drivin'* took five months to write. Day used a Tatung Einstein as a development system until the source code got too big, he then switched to a PC 386 PDS system. The final source code comes in at 200K, including the bitmap graphics Hex data. Day spent the first month optimising the polygon handling routines – the final game runs at 5 frames per second with a “virtually unlimited” number of on-screen objects. The CPC and C64 versions use the Spectrum's program code and data tables, “converting the source code onto the C64 was difficult – the original C64 programmer opted out – but the object shape data remains the same for all versions”. What this means to C64 gamers is – unfortunately – monochrome graphics, but Day offers “at least the C64 dash-board will be more colourful”. Day, a 24 year-old Cambridge graduate and Record Breaker (he's going into the 1990 Edition of the *Guinness Book of Records* for breaking the unicycling record from Land's End to John O'Groats in 14 days, 12 hours and 41 minutes – the

previous record was 19 days, 1 hour and 45 minutes), had only written one game before *Hard Drivin'* – *Double Dragon* on the PC. Day made the move from the PC to the Spectrum because, “the Spectrum is a simple clear cut machine to program with no complicated Operating System or graphic incompatibilities”. Day believes there will be increased emphasis towards 3D games in the future: “the new powerful graphics hardware will be put to good use”. His next game will either be another Spectrum coin-op conversion – probably Domark/Tengen's *STUN Runner* – or a 68000 programming project developing complex 3D routines. Jürgen Friedrich, a 25 year-old West German from Düsseldorf, wrote all the 16-bit versions of *Hard Drivin'* – except the Archie version which is being written by the *Inderdictor* programmers (see review on page 84). The game took about 6 months to write and was written



Jürgen 'well 'hard' Friedrich



Mike Day: programmer, record breaker and part-time juggler

on the ST using Turbo C and Art Director. The final source code is 350K-400K with a ratio of 70% C, 30% Assembler. The hardest part to write was the rotation code, the most difficult version was the PC, due to its lack of horsepower and differing graphics modes. The 16-bit versions maintain a frame rate of 8-10 a second, with over 150 objects on screen at the same time. Friedrich started out writing utilities for the Apple II, but he got so hooked on the Star Wars coin-op that he wrote a Mac version. *Hard Drivin'* is his second game, and he will probably be writing the 16-bit versions

of *STUN Runner*. Friedrich foresees a trend towards 3D graphics and more complex games with “artificial worlds where four or five players can interact together...”

#### Jürgen Friedrich

##### TOP FIVE MOVIES

- 1 BLADE RUNNER
- 2 ALIENS
- 3 VERTIGO
- 4 NORTH BY NW
- 5 DIVA

##### TOP FIVE MICROS

- 1 MAC II
- 2 ATARI ST
- 3 AMIGA
- 4 ARCHIMEDES
- 5 PC

#### Mike Day

##### TOP FIVE PAST-TIMES

- 1 GIRLFRIEND
- 2 JUGGLING
- 3 PROGRAMMING
- 4 WEIGHT-TRAINING
- 5 CYCLING

##### TOP FIVE GAMES

- 1 MAD PLANETS
- 2 HARD DRIVIN'
- 3 STUN RUNNER
- 4 BLASTERIODS
- 5 STAR WARS



Talk to Alien vessels



Explore Strange new Worlds

**BOLDLY GO WHERE NO GAME HAS GONE BEFORE!**



The Space Port

Available soon for Amiga, and ST (£24.99) and Commodore 64 disc (£14.99)

OUT NOW  
IBM  
£24.95

# STAR FLIGHT



TELECENTRONICS  
LANGLY BUSINESS CENTRE, 11-19 STATION ROAD, LANGLY, NR. STOLICH, BERKSHIRE SL3 8YN. TELEPHONE: 0753 49442



# Christmas Spirit... C

C+VG  
HIT!



## GH**OST**STBUSTERS™ II



ATARI ST SCREEN SHOTS SHOWN





# ... Christmas Cracker!



## POWER DRIFT



AMIGA SCREEN SHOTS SHOWN

# ACTIVISION

# SEGA

Power Drift™ and Sega are trademarks of Sega Enterprises Ltd. This game has been manufactured under license from Sega Enterprises Ltd., Japan © Sega 1988, 1989. Marketed and distributed by Activision (UK) Ltd.



# IN ARCADIA

HOMICIDAL FRENZY IN COIN-OP COUNTRY...

John Cook runs the gauntlet at the recent Associated Leisure Preview in London and discovers a promising new *Tetris* challenger...plus



## BLOCK HOLE Konami



*Tetris* is, as you may know, now a global phenomena. On Gameboy (it's bundled with the thing) alone we are talking 5 million and counting. Counting very fast too.

Not surprisingly, that means that just about every software company in the world is trying to produce another arcade puzzle game to be the next *Tetris*.

There have been some pretty bad attempts so far - Taito's *Plotting* probably being the worst - but now Konami have come up with an idea that is the best of the bunch yet.

*Block Hole* is almost like *Tetris* in reverse; *Tetris* meets *Space Invaders*, maybe? The game is this. You control a single space ship moving left/right along the bottom of the screen, just like *Invaders*. Likewise you fire vertically up the screen - but instead of laser fire, it's building blocks.

Down from the top of the screen comes a series of irregular shapes - loads at once. If one of these shapes reaches the bottom of the screen then you loose a life. So how do you get rid of these shapes? You have to fire bricks at them to make 'em rectangular - then they disappear. Then they start coming faster and faster. Dead simple isn't it? But it works.

There are a few other complications, but this is essentially it - and I can personally vouch that it has much of the appeal and addictiveness of its Big Brother.

As one of the most popular games on offer at the Preview, expect to see *Block Hole* littering the arcades early next year. And the collective unconscious being what it is, maybe a 'similar' home computer version soon after that!



## SPECIAL CRIMINAL INVESTIGATIONS Taito

In recent years, after *Op Wolf*, Taito's greatest success has to be *Chase HQ*. This was a chase driving game where you had to imagine you were in Miami Vice, driving a flash motor, zooming after assorted mobile villainy.

When you caught up with them, what did you have to do? Bash the bleedin' car into them until they burst into flames and pulled over. It

was never like this in *Z Cars*.

But despite its success, I always felt that *Chase HQ* had something missing. That elusive touch that is the dream of all motorists who have ever driven in London (ave. speed during rush hours, 14mph). And that is?

Simple. The ability to lean out of the car with a bazooka and blow all the other scum off

Many of the seaside arcades might seem a bit empty this time of year but, as usual, the trade is busy looking at the entrails of the odd sacred goat, throwing runes, and generally reflecting on what bought in the most money last season and what they'll have to buy to make even more next summer.

To this end, there are two major UK trade exhibitions in the Winter - the first of which was held recently in London - and very well attended too.

Arcade operators made the long trek to the Novotel in Hammersmith to see the latest hardware in action and they weren't disappointed. The big manufacturers take these shows very seriously and there were games that hadn't even been shown at the huge US AMOA show a few weeks previously.

### ORGIES OF DEATH

First the bad news. Just when you thought it was safe to go back into the arcades without sporting a flak jacket, both SNK and Sega come out with more electronic shooting galleries.

This is made all the more depressing buy Sega's effort, *Line of Fire*, being its first attempt to produce an *Op Wolf* clone - having held out for so long. Shown in prototype only, *Line of Fire* utilises Sega's well



*Line of Fire*

tried and tested sprite expansion technology, with well drawn scenery and human military types coming towards you at a constant rate. All you have to do is engage finger onto fire button then disengage both conscience and frontal lobes.

Rather than limiting the player's (and there can be up to two of you) ammunition, Sega have plumped for a bonus based on your percentage of hits - and overall the game seems an excellent example of its type - although I am still mildly dismayed that anyone should want to pay good money to blow away fake human beings.

At least *Line of Fire* tries to remove the action a little way from reality by using



large cartoon bubbles with "Ouch" in, to denote when you get hit.

SNK, of course, had a big success with *Mechanised Attack* - a two player clone of *Op Wolf* - which was, strangely, a great deal more successful than Taito's own follow-up to the mega-hit, *Operation*



**Beast Busters**

*Thunderbolt*. Will they repeat this with *Beast Busters*?

This can be played by up to three players simultaneously - but gone are the human-like sprites. With this one you are blowing away ghosties, goblins and things that look like they've got terminal wet rot. I'd call it a cross between *Op Wolf* and Namco's *Splatterhouse* myself - and as such I guess, skating on my philosophically thin ice, I'd rather see people playing this obviously surreal game than something more 'realistic'.

It'll be interesting to see if these second generation shooting matches have as much success as the former breed - but you can bet they won't install either at the Red Lion in Hungerford.

**PINBALL POWER**

Two bits of good news from the Show, however. Firstly Pinball seems to be making something of a minor comeback - which only goes to show that some punters have got a bit of common. In the USA the revenue split between vids and pinball is around 45/55, but it's nowhere near that high in the UK - as yet. With the great tables that are being produced at the moment, however - *Black Knight 2000*, *Monday Night Football*, *Police Force*, *Elvira*, *Bone Busters*, etc, maybe that will change over here?

Secondly, someone has come up with an arcade puzzle game that is almost as good as *Tetris* (*Block Hole* - see below). Let's hope there are lots more to come.

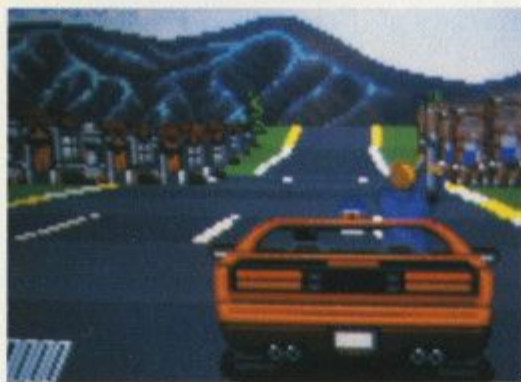
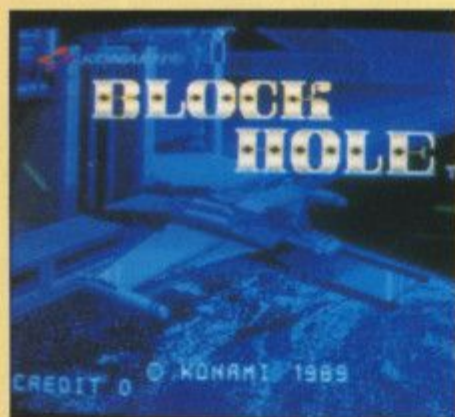

the road (tee, hee, gibber, gibber). *Special Criminal Investigations* - effectively *Chase HQ II* - allows you to do this and by golly it is so satisfying that I've got the psychoanalyst booked already.

Controls are almost identical to *Chase*, with the addition of fire buttons on the strut of the steering wheel. Press it and - boring - at first you just get a pea shooter of a piece to administer truth and justice with.

But if you're good - very, very good - the DA

◀ **Special Criminal Investigations**



drops you upgraded hardware by helicopter and then the fun really starts. Kaboom!

Not the kind of thing you expect to get a great deal of intellectual stimulation from - but if they ever release an M25 scenery ROM for it you'll have to prise me off the cabinet with a crowbar.



**EXTERMINATOR**  
**Gottlieb**

Gottlieb? Who are they? Well hold on a bit, Gottlieb generally makes quite good pintables - the latest being a super-fast effort called *Bone Busters*. But curiously, it has now entered the video market - and in the weirdest possible way.

People like me often criticize manufacturers for lack of imagination and choosing to make safe and easy games. But there again, it's not our houses on the line if the games bomb!

I anticipate someone at Gottlieb is either going to be very rich - or homeless - in the near future, as *Exterminator* is a completely new and fresh game. As such it seemed bewildering to many operators.

The look of the thing for a start - digitised backgrounds and sprites. The theme; surreal man! You control a disembodied hand which can stamp on and fire at attack waves of household objects that come out of the screen at you.

A non-standard control system doesn't help matters much - making the game quite difficult to get into. And I'm not even sure if I like it or not. But it show that someone can still use their imagination and is still willing to take a flyer in this business. For that at least, I strongly recommend you give it a try.



↕ **Exterminator**







Actual C.64 Screenshots



S Y S T E M 3

SYSTEM 3 SOFTWARE, BLENHEIM HOUSE, 1 ASH HILL DRIVE, PINNER, MIDDLESEX HA5 2AG  
 Telephone: 01 866 5692 FAX: 01 866 8584

AVAILABLE ON SPECTRUM AMSTRAD CPC C.64 AMIGA ATARI ST



# ACE LETTERS

YET MORE MOANS – AND VERY UNDERSTANDABLE TOO – ABOUT THE LACK OF VERSIONS FOR CERTAIN MACHINES, A HEART-WARMING STORY OF COMPUTER GAMING SOLIDARITY AND A SAD TALE OF A MOTHER'S GAMES OBSESSION DEPRIVING HER SON OF TIME ON THE MACHINE...

## WHERE OH WHERE?

A few issues ago in ACE the Firebird game Rainbow Islands was reviewed. It was rated 934 and I thought it would be a great game to get for ST. Since then I have heard nothing about it. All the mail order companies I have phoned don't have it, it's not in any of my local software shops and I was surprised not to find it in you Xmas '89 runners and drivers section. Can you tell me what's happened to it?

Also, do you know if the arcade game Prehistoric Isle will be converted to the home computer? Is Golden Age being converted?

Craig Sutherland, Scone

There will be probably be an ST version of Rainbow Islands, but just at the moment it's anybody's guess when, or on what label, it will appear. As for the other two games you mention, we haven't heard of any conversions under-way.

## MOUSE GROUSE

May I appeal to games designers, programmers and software houses to always include a facility to play from the keyboard and the mouse. Some of us out here use our computers for work and a) haven't got the room and b) don't want to have joysticks around. There are several games I would have purchased but I was deterred from buying them as they were joystick only. I can fly around and blow things up perfectly adequately on Mirrorsoft's Falcon without recourse to the joystick. So come on programmers – make sure that your products are available to the widest possible audience by including keyboard or mouse or joystick playing.

Secondly, although I have read that some software companies are abandoning the Atari ST for the Amiga, are they really so foolish as to forget the hundreds of thousands of potential Atari ST software buyers?

Mike Taylor, Hamburg

*If you're interested in games it really is time you got round to buying a joystick; it makes a lot of games a whole lot easier and more enjoyable. However, we take your point – programmers should, wherever possible, include mouse and keys options. As for your second point we doubt whether software houses are quite so foolish as to abandon the ST. It's a strong market for them, especially in Europe, and they aren't going to turn down the chance of making more money, are they?*

## HOURS OF FUN

I must say I've had hours of fun playing with the 'Get 12 Issues Of ACE Comfortably Into The Folder' game that you gave away free when I last renewed my subscription.

Unfortunately, I have to admit that it has me beaten, although I did manage 11 issues before the folder exploded, showering me and the bedroom with bits of wire, magazine articles, and other assorted debris.

Can I, through your pages, ask if anybody has beaten my record (which included last December's bumper issue)?

Malcolm Crawley, Saltdean, Sussex

*Despite a collective IQ that fails to make three figures we can reveal that members of the ACE team have indeed broken your record, smoothly inserting all 12 of the year's issues into one binder.*

## GOD SQUAD

Dear mortal ACE readers, I am the Deity who plans to make sure that violent computer games stay, not only on Earth but in the whole Universe.

I believe that a computer game does not turn J.B. Good into that Terminator or anyone else for that matter. Violent games are great for letting off steam, and just for great fun.

When my followers are killed on the field of Populous I turn to Operation Wolf to do the job myself. No, I don't throw bolts of lightning at innocent humans, I don't even pick up an M-16 and turn to extreme violence – I turn on my ST!

Why must some stupid mortals go against violent games? soon it will be violent TV shows. I will never understand why some mortals believe that violent games cause murders and so on. I'll bet my Godliness that it's because they never got to play a violent game.

I would like to make ACE the God of ALL computer magazines!

Zsott Malota, New South Wales, Australia

*Your wish is our command; from now on ACE is the God of all computer magazines.*

## ST SALT OF THE EARTH

At 8 pm (or 20 hundred hours as those naval types say) I received a phone call from a fellow ST user. He had seen my plea for help in your helpline column and proceeded to provide me with the cheat mode to Psygnosis' Barbarian. In my hurry to load up I did not thank him for his long distance call. So to the Lancashire bloke who saved my hair (private joke) I'd like to say THANKS!

I'd appreciate you printing this letter as I feel it shows the good nature of ST users.

Tom Woodforde, Enstone, Oxon

*Fair warms the cockles of yer heart, don't it?*

## INFERNAL ENGINE

I was very interested to read your

article about the PC Engine. Our 13-year-old son has driven us mad with computer games for the last two years. So, when he read a report earlier this year in various mags about the PC Engine, he had to have one.

So in June of this year when for months he had saved to buy one we went along to a shop in London. full of excitement we got it home and – guess what? All it did was flash and roll up the screen. The game had cost £45 so I was hopping mad. we went back to the shop and it worked for them. We travelled up to London eight times; each time they changed parts and games but nothing helped. I demanded my money back, but all they would give me was a credit note. This we took, but when we went back they gave us another PC Engine as they didn't sell anything else my son wanted. Then I discovered it worked on my old black and white television – and on TVs that had vertical hold knobs. So we bought an old colour TV and,



# THE BEST OF THE BEST

## T'R I A 'D

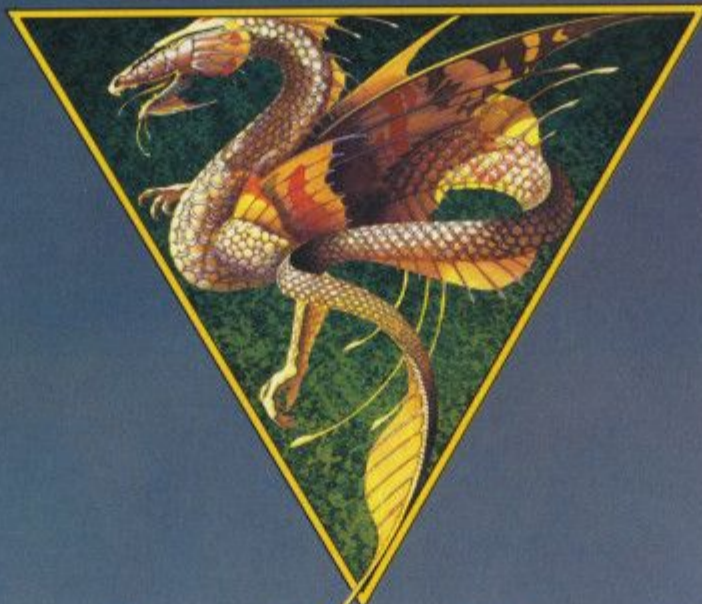

### V O L U M E • 2

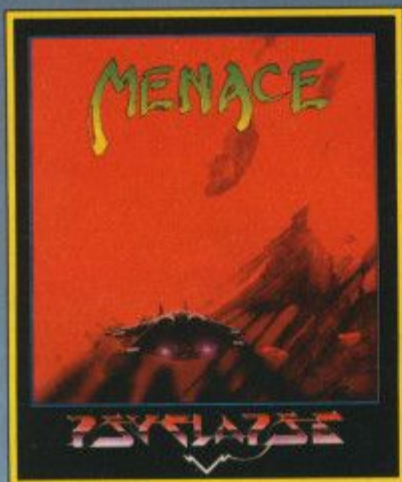

**ST Amiga Format - Gold Disk Award**  
 "Menace will have you hooked for hours on end. The addictive "just one more game" feeling hits you every time."

**ST Action**  
 "This game is non-stop action all the way - miss it at your peril."

**Page 6**  
 "Menace is a superb game which is impressively presented. Menace excels in terms of playability. It is a highly addictive game with enough variety for you to keep wanting to come back for more."

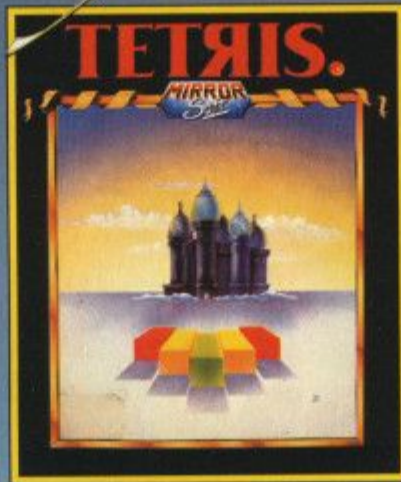

**Sinclair User - 10**  
 "The most original and playable game in an age."

**Atari ST User - 9**  
 "Tetris is one of those horribly addictive games that gets you saying 'Just one more game'."

**Zzap - 94%**  
 "One of the all-time computer classics . . . it's perfectly simple and simply perfect."

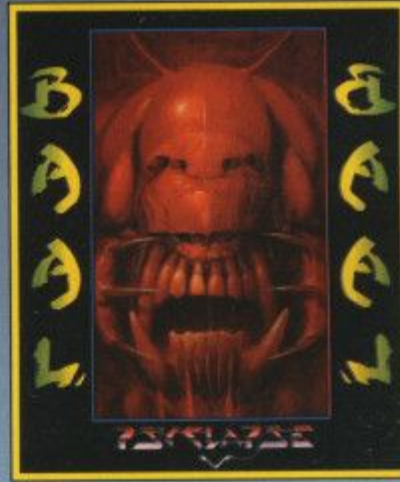

**C + VG**  
 "If you're after an addictive and action packed exploration game, buy Baal."

**Atari ST User - Star Game**  
 "What a brilliant game - surely Psygnosis' best to date? The graphics have to be seen to be believed and the scrolling is excellent."

**ST Action**  
 "A brilliant mixture of fine artwork, taxing strategy and all out arcade action, this game will really put you on the edge of your seat."



**PSYGNOSIS LIMITED**  
 Century Buildings,  
 Tower Street,  
 Liverpool L3 4BJ,  
 051-709 5755



Bingo!, it worked.

So now I read your article about PC Engines in ACE I know it was not us. I think more research should have gone into this Engine before it was allowed to be sold in the United Kingdom.

**Mrs. P. Priestley, Croydon**

*It's a sad tale, Mrs. Priestley, and we can only commiserate with you. We're mystified as to why the shop wouldn't give you your money back. But at least with your old colour telly things seem to be a bit more fun now.*

## MEAN MUM

Way back in 1983 my sister received a Speccy 48K for Christmas. All went well for two years, then two problems arose.

One was that I accidentally bought a game, Haunted Hedges, which is pathetic. My mum can't last five minutes without it. And, two, the pressure pads are bust (no thanks to Daley Thompson).

So as I got sick of this I bought a C64 two years ago. The problem is, though, that we've only got one TV for the two computers, and I never get to play the C64.

So I'm asking you to do a little review on the letters pages and tell my mum how good or bad it is.

**Paul Evans, Wallasey, Merseyside**

*Come on Mrs. Evans - have a heart! It's just not fair depriving your son of his fun on the C64. Give it a whirl - you might even like it yourself.*

## BUG HUNTER

I have found a bug in the PC version of The Amazing Spiderman and Captain America in Dr. Doom's Revenge. Any time during the game you can save your position at the comic screens by pressing B. Later on in the game when you die press Y in the Statue of Liberty scene. When you see the starting comic screen then press R and you should return to your saved position with full energy.

**Alex Young**

## F-16 COMBAT LETTER

I write to express my disappointment with your recent review of Digital Integration's F-16 Combat Pilot game on the Amiga. I dispute that the game is superior or even comparable to Interceptor, or that it is the 'best of the bunch' as you describe.

Digital Integration cannot be oblivious to the fact that a lot of serious Amiga simulation players enjoy the benefits of two disk drives. So why do they find it necessary to release an expensive 'quality' computer program which reduces the hapless purchaser to a state of constant disk-swapping? The game is far from user-friendly: I am no stranger to computers but it took me a good twenty minutes to figure out the Data Disk requests, which of course go undocumented in what passes for a manual. The graphics that greet the player in the mess room are blocky and poor, the character set in which the text for messages is presented is barely legible, and the mouse pointer is flickery and jerky.

The finish of the product is nowhere near that of Interceptor. If you need reminding, load Interceptor up and compare the sound: on F-16 Combat Pilot, for the engine we hear an undulating cacophony of white noise - while Interceptor boasts a full-throated engine noise and realistic weapon sound effects. On Interceptor we have responsive, intelligent controls - a quick stab on the keyboard is all that's needed for undercarriage, brakes, radar etc. - and it's all very clear on the display. Combat Pilot, however, is quite a different affair. Key-presses are 'sticky' and everything makes the same 'bleep' - there is no quick touch, no quick response, and often pressing a key produces no net effect at all and it needs to be pressed twice! This is certainly no the way a simulation should be.

The aircraft movement is also vastly inferior to Interceptor: nowhere do we have the sensation of speed, nowhere can we investigate the scenery or accurately whizz within inches of control tower or suspension bridge. And as controls go, joystick response in combat Pilot is jerky and lacks any sort of 'feel'. The scenery can only be described as crap. A few old rocks and a tawdry white building here and there to break up the monotony, and where are the 'out of cockpit' all round views on Combat Pilot as seen in Interceptor and nobler underdog Falcon? They're not - and we quickly lose another enjoyable element. Of course, it may well be very realistic, it may well be that sitting inside a real F-16 induces one to continually and needlessly swap floppy disks. It may well be true that written instructions from the aircraft are near-illegible, it may well be true that written instructions from the aircraft are near intelligible. It may be an unfortunate side-effect of flying such aeroplanes that from one's cockpit mountains all look like great pink pyramids. The silly booklet protection scheme I can live with - but then let's get this into perspective: who'd want to copy this programming the first place? It's a waste of money and I feel that is a shame that popular magazines can longer be relied on for good advice. Next time, regardless of how highly you rate a program, I shall make damn sure that I get an 'evaluation' copy from a friend before I lay out more of my hard-earned cash.

I have been an Amiga owner for a year but an ACE reader for only one issue. If you wish to keep your readership you simply cannot continue giving ratings like 970 to programs so flawed and of such obviously poor quality. 9 man years it may well have

taken, but it takes me four hours to earn £25 - and that's half a day of my life. I didn't need to spend money on the game - but putting my faith in your judgement I did so and I regret it. So please, in future, remember that just because a game is getting old (e.g. Interceptor) it does not mean that it isn't still the best of its kind or that you should forget it and needlessly applaud potential rivals to theretch-inducing degree of sycophancy witnessed in the F-16 Combat Pilot review: 'the aircraft's stability is quite incredible'. Cough! And '...response and feel of the aircraft is superlative.' Choke! And how about '...an essential addition to your collection.' Well, it isn't essential to mine and has provided me with about as much enjoyment as watching the plastic plants grow at Newport Pagnell MacDonald's.

So come on chaps, consider the users out here. To prevent reviews of this sort being repeated it would probably be advisable to have more than one reviewer 'on the case,' for any one program or to provide the names of the reviewers responsible for the individual reviews so that we know whose judgement may be more in line with that of the reading individual. This is the way the old Crash magazine used to work and I have not seen a better reviewing system anywhere else. And these days, with stales as high as £25-30, mistakes are costly.

**Richard A. Harrison, London**

**ACE Reviews Editor, Laurence Scotford, replies:**

*Unfortunately you seem to have misread, or misunderstood this review. The phrase "the best of the bunch" was comparing the Amiga version of F-16 combat pilot with other versions of the same game. At no point in the review was there any direct comparison with any of the other products you mention.*

*I'm afraid that I really cannot agree with your slating of F-16 Combat Pilot. It is a program designed to appeal to simulator fans who are looking for realism, rather than general game players who would be more interested in gimmicks such as the out of cockpit views that you mention.*

*Regarding the problems that you had with flickery pointers and sticky keys, we experienced none of these. I would suggest that the problems may be caused by either a defective machine or defective software.*

*Although ACE reviewers try to be as fair and objective as possible in the way that they review games, it is impossible to ignore the fact that personal opinion and tastes will always figure in any review in any magazine. It is inevitable that occasionally a reviewer's feelings about a product will not concord with your own. In the case of this particular simulation I ought to point out that yours is the only letter of disagreement we have received. Furthermore, if you care to glance at our Stockmarket feature on page 163 of the December Issue, you will see that F16 Combat Pilot was the most highly rated program across all the entertainment magazines that month. Obviously I am not alone in my opinion of the product!*



## CLEAR FOR TAKE OFF

I have just read your write-up of the Bomber flight simulator. In it Mr. Lewis of Vektor Graphics states that 'all sims before have been either commercial Lear Jets and Cessnas or they've been fighters.' Now I'd like to know if there are any commercial jet flight simulator games around, as I'd love to take to the skies in a Boeing 757 or an Airbus 310, landing at airports like Paris and New York before getting back to Gatwick.

I know that Flight Simulator does have different scenery disks for Europe, Japan, etc., but as far as I know their flight instructions only cover Lear's and Cessnas.

It would be nice if someone brought out a commercial flight sim with the same cockpit detail as Falcon or F-16 and combined it with different scenery disks. I would be grateful if you could give me any info on games about, or if any software publisher plans to produce one.

**A. Turville, Warninglid, Sussex**

No, we don't know of any such games. There was an arcade machine from Taito called (if memory serves us well) Taito Airline. The problem with this thing was that hardly anybody played it - probably because it was too boring compared to the other delights on offer. There are two main problems with the kind of game you'd like to see; there's no fighting (unless you introduce a hijacking element) and there's no great test of flying skill - smaller planes such as the Cessna needing more control than the big uns. So we think it's unlikely you'll see that game...

## ARCHIE ANGST

I occasionally buy ACE as I find your game reviews the best of any magazine. However, I own a BBC B and shortly intend to upgrade to an Acorn A3000. Unfortunately I don't share K. Pardesi's view that Archie games are receiving more coverage in ACE; if they are, it's very slow progress.

I am aware of 65 games currently available for the Archie and another 39 under development which should be ready by Christmas. How many have been fea-

## VERY, VERY SAD

I was/am very very sad when I read a letter by another Dutchman (Eddy Borremans) in ACE from November saying that it's completely normal to copy games in Holland, and that computers are only bought because you can get your software for free and as such is part of our culture.

Well let me set this straight at once. Eddy should shut up and stop generalising with everything he says because he makes other people think that the whole of Holland is a bunch of software pirates who find it quite normal to copy games. Well, it ain't true.

I have owned a C64, which included a lot of games and of course there were copies, but I can proudly say that about 75% of the top-of-range games I owned were bought (by airmail in England, because it's cheaper).

Of course I 'understand' why they copy:

- 1) they want to be able to brag to their friends about the amount of games they own. This shows how spoiled these RATS really are.
- 2) The games they copy are indeed very expensive - which is no reason to do it.

I read in his letter that he is a computer science student, who probably doesn't know anything about economics. Otherwise he would have known that if the number of games sold goes up, the company can lower the price because they have to make less profit on each game to reach their goal.

It is quite unbelievable that Eddy is a student. It would be better to describe him as a man with the brains of a 12-year-old and someone who doesn't deserve to be Dutch.

**Richard van Gils, Utrecht,**

**Holland**

*Stern words - would Eddy like to reply?*

tured in ACE? Five, if you're lucky.

Sure, the user base is small at the moment, but then again how many have got the PC Engine? With its speed, graphics and sound capabilities there are going to be very few consoles that can match the Archie's game-playing ability and of course it is first and foremost a powerful computer.

I look forward to the games promised by the likes of Domark and Ocean and also to the smaller names like Impact, Periscope, Clares and CIS, all of whom should be congratulated for their efforts and for taking a risk.

In the meantime, how about ACE reviewing Interdictor, E-Type or Karma? The Archie deserves some attention and in the end it can only be good news for ST and Amiga owners too when games of the quality of Zarch/Virus are converted to run on their machines.

**Alex Card, Aldeburgh, Suffolk**

*Take a gander at page 84 of this issue and you will find a review of Interdictor on the Archie - which will, we promise, be the first of many reviews*

## ONE BIT BRAIN

Someone with a one-bit processor for a brain actually had the nerve to compare a games console with a computer (ACE 26). What's next? some girl writing to you, telling you she prefers her Barbie doll to her bother's Amiga?

I don't care if the latest consoles go up to the 16 billion colours and make your chair move along with the action. They are TOYS and a computer isn't. I'd like to see Chris Blowes design a cover for a club magazine, make an advert with a DTP program, write a letter, etc., with his Sega. Computer users can do all of that (and a lot more) and still enjoy a good game afterwards.

Someone also complained about the low ratings of Sega games. No wonder - only racing, beat 'em ups and shoot 'em ups. What about GOOD games like RPG and adventures? What about Populous, Dungeon Master and Sim City, to name but a few ACE rated games? Never seen one of those on a Sega. Someone mentioned Thunderblade? I played it once, and found it to be completely stupid and boring. Compare this with F-16 Combat Pilot and Falcon and you'll see what I mean.

Mind you, I don't look down on console players, but they have to play in their own league. It's like someone in a Lada with racing stripes who thinks he can beat a Porsche. If your only desire is playing games? Good. Buy a console. But if you want something that is a challenge every day, that is endlessly more versatile and creative and makes your brain work, buy a computer.

**Luc Stynen, Berchem, Belgium**

*'Don't look down on console players? Come off it chum - you think they're the pits.'*



# THEY'RE BACK...



# 双截龍

# DOUBLE DRAGON

## The Revenge™



### AVAILABLE ON

IBM PC	£24.99
ATARI ST	£19.99
AMIGA	£19.99
CBM 64 CASS	£9.99
CBM 64 DISK	£14.99
SPECTRUM CASS	£9.99
SPECTRUM +3	£14.99
COMING SOON!	
AMSTRAD CASS	£9.99
AMSTRAD DISK	£14.99



VIRGIN GAMES • 2-4 VERNON YARD  
 119 PORTOBELLO ROAD • LONDON W11 2DX  
 "COPYRIGHT © 1989 AMERICAN TECHNOS INC. ALL RIGHTS RESERVED"  
 "AMERICAN TECHNOS™" "DOUBLE DRAGON II™" "THE REVENGE™"  
 THIS GAME HAS BEEN MANUFACTURED UNDER LICENSE FROM AMERICAN TECHNOS INC



# Bloodwych



**ARGUE! BARTER!  
LIE THROUGH  
YOUR TEETH!!!**



Atari ST Screen Shots



Amiga  
Atari ST

£24.99  
£24.99

As the people of the Bloodwych awake to a new dawn, they find a stranger in their midst – from one of many races he has come. His task; to halt the demon that lies dormant within the Castle of the Bloodwych.

Unification of the Crystals of Sanguis will secure the Behemoth in his lair for all eternity. Should they remain separate, then he shall rise to bring darkness into the world.

This unique role-playing fantasy game allows greater interaction with the environment than has ever been seen before. Argue, barter, negotiate – even lie through your teeth! The fully implemented personalities of all the characters in Bloodwych allows a rich style of role-playing that has only been dreamt of.

With one or two player simultaneous mode, this is the game that you've been waiting for. Bloodwych for those that dare!



# THE ACE STOCK MARKET

HERE'S WHERE YOU CHECK OUT WHICH GAMES ARE GETTING THE HOTTEST REVIEWS IN MAGAZINES AROUND THE COUNTRY - THE HOT RELEASES YOU MUSTN'T MISS. YOU CAN ALSO PRACTISE YOUR GAMES MARKET SKILLS BY PREDICTING NEXT MONTH'S FIGURES - AND WIN GREAT PRIZES! THE ENTRY FORM IS ON PAGE 24..

The ACE Stockmarket is really getting into full swing this month. You can see for the first time how the 'share prices' of the various software house's have fluctuated (see the Company Counter on the right) and, if you were one of the many readers who sent in the form for Round One, you can check out whether you're due for a prize.

If you missed Round One, here's a quick recap. The stockmarket trades over four counters. The **8-bit Counter** features the top ten games on Amstrad, Spectrum, and C64. The **16-bit Counter** features the top ten for the ST, Amiga, and PC.

In addition to the two 'Processor Counters' there is also the **Machine Counter**. Here the top five games for each of the six most popular machines are listed.

Remember that these listings are different. They are not your typical chart entries, which rely simply on sales. Here at ACE we've always distrusted that method of charting: a game that's been hyped outrageously can always sell its way to the top, before everyone realises that it's a pile of rubbish and consigns it to the rubbish bin.

Instead, the ACE Stockmarket fixes its prices according to the **reviews ratings** each game has received in the UK Magazines. Our researchers read every magazine they can get their hands on during the month, and the games that top the ACE Charts really deserve to be there. So you can not only use the Stockmarket to win prizes, but you can also treat it as a valuable buying guide.

In order to give a fair and true overall picture of a title or company's rating, and to guard against 'rogue' reviews, ratings are statistically weighted, and titles must have more than one single review rating to be included in the Machine Counter and the Processor Counters. Similarly, publishers must have more than one product to qualify in the Company Counter. This explains why some titles appear in some charts and not others.

On the page overleaf you'll also find an entry form. Check out the Stockmarket each month, get a feeling for the way the market changes as the software companies release new titles during the year, and watch out for ACE rated games, any one of which may be a contender for one of the Stockmarket entries. And a really high rating could drive up the share price of the company that released it.

Then try to forecast next month's positions. There's £25 worth of software waiting for the first winner in each category to be picked at random on the closing date. Don't miss it!

## THE COMPANY COUNTER

There three columns of ratings for companies each month in the ACE Stock Market. The first shows the overall score for this month only, statistically calculated from hundreds of reviews in magazines during the current month. The second shows the amount of change - up or down - from the previous month. The third is the share price: the company's rating relative to its past performance. To get into the share price listing, companies need to be releasing products reviewed by magazines. To see their fortunes rise, they need to be consistently improving their product. In the short term, the 'one-hit wonder' will seem to do well; in the longer term, consistency will pay off.

Delphine's fortunes took a sharp Stock Market upturn when it followed up the tepidly-received Castle Warrior with Future Wars. But can Delphine keep up this rate of improvement. Reline's Oil Imperium is obviously growing on people, while The Edge's budget label RAD is unearthing some lost long treasures in its golden oldie catalogue.

ACE tip for next month's top five: Rainbow Arts. Rock'n'Roll is one of the hot titles of the moment (see the Machine and Processor charts) and this month's review ratings should see its share price soar.

Publisher	This mth	+ or -	Rating			
Delphine/Palace	88.75	+35.92	167.99	Bethesda	74	n/a 100*
RAD (The Edge)	80	+14.33	121.82	Shades		
Reline	80.25	+13.65	120.5	(Grand Slam)	70.67	n/a 100*
Gremlin	73.38	+11.78	119.12	Wicked	63.25	n/a 100*
Gainstar	76.33	+8.16	111.97	Dinamic	50.41	n/a 100*
Players Premier	73.25	+7.08	110.7	Impressions	46.5	n/a 100*
System 3	80.42	+7.42	110.16	Anco	41.67	n/a 100*
Hewson	74.99	+6.67	109.76	Mindscape	79.86	-0.14 99.83
US Gold	80.55	+6.78	109.19	Activision	73.9	-0.19 99.74
				Mastertronic	63	-0.2 99.68
				Psygnosis	76.5	-0.33 99.57
				UbiSoft	78	-0.35 99.55
				Encore	60.86	-2.01 96.8
				16-Blitz	76.67	-3.16 96.04
				Actl Screenshots	70.5	-4 94.63
				Byte Back	65	-3.88 94.37
				Elite	65.76	-6.13 91.47
				Microprose	75.4	-7.52 90.93
				Micro Style	70.36	-7.81 90.01
				Firebird	64.33	-8.43 88.41
				Alternative	67	-10 87.01
				Infocom	76	-13.19 85.21
				Infogrames	61.1	-14.11 81.24
				Accolade	52	-13.33 79.6
				Hit Squad	68.17	-17.58 79.5
				Grand Slam	57.33	-20.67 73.5
				Artronic	53.25	-25.75 67.41
				PSS	53	-26.46 66.7
				CDS	47.8	-27.33 63.62



LAND ID: 14TR/SEA ID: 1 TIME: 10:00 CONTINUE  
Lucasfilm's/US Gold Battle of Britain Simulator could storm the charts...

Microllusions	79.4	+5.48	107.41
Digital Int'n	100	+5.3	105.6
Domark	77.77	+3.85	105.21
Virgin	68.3	+2.89	104.42
Kixx	71.3	+2.67	103.89
Epyx/US Gold	82.13	+1.25	101.55
Ocean	83.48	+1.27	101.54
Image Works	83.83	+0.61	100.73
SSI/US Gold	76.5	+0.31	100.41
Electronic Arts	75.58	+0.16	100.21
Novagen	94.13	n/a	100*
Blade	89.33	n/a	100*
Level 9	87.63	n/a	100*
Beau Jolly	86.33	n/a	100*
Origin	79.94	n/a	100*
Rainbow Arts	74.15	n/a	100*



Entries marked with an \* are new this month.



# THE MACHINE COUNTER

## AMIGA RATINGS

F16 Combat Pilot	Digital Integration	97.33
Rock'n'Roll	Rainbow Arts	92.17
Xenon II: Megablast	Image Works	89.87
Laser Squad	Blade	89.33
Batman - the Movie	Ocean	89.27

Delphine/Palace's *Future Wars* just missed out on a placing here in a very high scoring month for Amiga games. *F16 Combat Pilot* still rules the roost - how on earth will Digital Integration keep up this sort of scoring?

## ATARI ST RATINGS

Damocles	Novagen	94.63
Xenon II: Megablast	Image Works	91.13
Interphase	Image Works	89.6
Paperboy	Elite	87
Games: Summer Edition	US Gold	85

Two in the top five for Image Works, but *Xenon II* is pretty well played out now - you'll see more solutions and playing tips for it than reviews - whereas *Damocles* is only just getting going.

## PC-COMPATIBLE RATINGS

Carrier Command	Rainbird	98.25
Bomber	Activision	92.08
F15 Strike Eagle II	Microprose	87.75
M1 Tank Platoon	Microprose	87.5
Indiana Jones Adv	US Gold	84.75

It's not compulsory to make your PC games aerial combat simulations - but it obviously helps. That's three in the top five for Microprose as well, now that *Rainbird* is under its wing, and PC *Carrier Command* must surely be one of the most highly rated titles ever.

## SPECTRUM RATINGS

Myth	System 3	94
Untouchables	Ocean	92.92
Operation T'bolt	Ocean	92
Batman - the Movie	Ocean	91.01
Ghouls'n'Ghosts	US Gold	88

All very tight in the Spectrum top five. Ocean's *Batman* and *Untouchables* have had rave reviews everywhere - see them slip to make room for something else next month.

## COMMODORE 64 RATINGS

Turbo Outrun	US Gold	95
Myth	System 3	92.5
Ghosts'n'Goblins	Encore	92
Power Drift	Activision	90.07
Omega	Origin	87.5

Straight in at number one, and the first reviews of *Turbo OutRun* are wildly enthusiastic. It will be interesting to see how the other formats score over the next couple of months (we certainly didn't like the ST version). But the consistently high rating of *Ghosts'n'Goblins* shows that some of the oldies can still hold their own with the flashy products of today.

## AMSTRAD CPC RATINGS

Batman - the Movie	Ocean	91.5
Christmas Collection	Hewson	87.5
Dynamite Dux	Activision	86
Dragon Spirit	Domark	80.75
Shinobi	Virgin	75

Signs here that the CPC sometimes gets the best of the 8-bit conversions: *Dragon Spirit* and *Shinobi*, which were both in last month's top five as well, have had consistently better reviews on the CPC than other formats.

## THE 16-BIT COUNTER

It looks as though it was worth the wait for *Damocles* - the reviewers are raving about it and it goes straight in at number one. Also scoring consistently over 90% is *Rock'n'Roll* - and with only a tiny fraction of the publicity of its neighbours at numbers one and three.

Damocles	Novagen (Am, ST)	94.13
Rock'n'Roll	Rainbow Arts (Am)	92.17
Xenon II: Megablast	Image Works (Am, ST)	89.67
Interphase	Image Works (Am, ST)	88.9
Future Wars	Delphine/Palace (Am)	88.75
Continental Circus	Virgin (Am, ST)	87.34
Stunt Car Racer	Micro Style (Am, ST)	87
Batman - the Movie	Ocean (Am)	86.5
Paperboy	Elite (PC, ST)	86.25
Onslaught	Hewson (Am, ST)	86

Bubbling under: *Ninja Warriors*, *Stormlord*, *Indiana Jones - the Adventure*.

## THE 8-BIT COUNTER

Here at ACE we were noticeably less enthusiastic than most about this month's number one, *Power Drift*. It will be interesting to see how it fares next month, when its Spectrum ratings should be included. And if you're looking for a compilation this Christmas, there are plenty of goodies to choose from.

Power Drift	Activision (C64, CPC)	88.57
Christmas Collection	Hewson (C64, CPC, Sp)	86.67
Ghouls'n'Ghosts	US Gold (CPC, Sp)	86.5
Operation Thunderbolt	Ocean (C64, Sp)	86.5
Tolkien Trilogy	Beau Jolly (C64, CPC, Sp)	86.33
Ghosts'n'Goblins	Encore (C64, Sp)	85.75
Cabal	Ocean (C64, Sp)	85.67
C & VG Coin-Op Hits	US Gold (C64, CPC, Sp)	85.67
Stunt Car Racer	Micro Style (C64)	84.78
Batman - the Movie	Ocean (C64, CPC, Sp)	84.56

Bubbling under: *Tusker*, *Dark Force*, *Winners*, and *Dynamite Dux*

# THE ACE STOCKMARKET ENTRY FORM

NAME: ..... Address: .....

..... Telephone No. ....

## ROUND TWO

Post this form or a photocopy to  
ACE Stockmarket, Priory Court, 30-  
32 Farringdon Lane, EC1R 3AU.  
Closing date 24th December 1989.

My prediction for next month's top five software houses on the Company Counter is:

- 1.....
- 2.....
- 3.....
- 4.....
- 5.....

My prediction for next month's top five game on the Commodore 64 is:

- 1.....
- 2.....
- 3.....
- 4.....
- 5.....

My prediction for next month's top five games on the Spectrum is:

- 1.....
- 2.....
- 3.....
- 4.....
- 5.....

My prediction for next month's top five games on the Amstrad CPC is:

- 1.....
- 2.....
- 3.....
- 4.....
- 5.....

My prediction for next month's top five games on the Atari ST is:

- 1.....
- 2.....
- 3.....
- 4.....
- 5.....

My prediction for next month's top five games on the Amiga is:

- 1.....
- 2.....
- 3.....
- 4.....
- 5.....

Rules:  
All entries must be received by the closing date for this round of December 24th 1989.

No employees of EMAP, or of any company involved in the production, distribution, or sale of ACE Magazine are eligible for entry.

Only one entry per household.

The decision of the judges is final and correspondence cannot be entered into.



95  
92.5  
92  
90.07  
87.5

Turbo  
g to see  
of  
ut the  
that  
flashy

91.5  
87.5  
86  
80.75  
75

of the 8-  
were  
sistently



es next  
king  
from.

88.57  
86.67  
86.5  
86.5  
86.33  
85.75  
85.67  
85.67  
84.78  
84.56

M

op five

osing  
1989.

mpany  
i, or sale

corre-

# SAMURAI™

The place: 16th century Japan. You are a Samurai, a warrior who lives for honour. Your world teems with opportunities to achieve it . . . or lose it. The ultimate honour – to become Shogun and unite all of Japan under your rule – is a prize worthy of only the greatest of Samurai.

Action, adventure, historical accuracy; Samurai advances the gaming genre. MicroProse pioneered so successfully in Pirates!

Available for IBM PC and compatibles.

Unit 1, Hampton Road Industrial Estate, Tetbury, Glos. GL8 8DA.  
Tel: 0666 504326/504412.

**MICRO PROSE**  
SIMULATION • SOFTWARE





# CABAL



AMSTRAD  
SPECTRUM  
COMMODORE  
**£9.99**

Ocean Software Limited  
6 Central Street · Manchester  
Telephone: 061 832 6633  
Telex: 669977 OCEANS G  
Fax: 061 834 0650

**ocean**<sup>®</sup>

**MEGADETH**  
"CABAL IS WITHOUT A DOUBT ONE OF THE FINEST CONVERSIONS I'VE SEEN ... ONE OF THE ULTIMATE SHOOT-EM-UPS." YOUR SINCLAIR USER

**SINCLAIR USER**  
"GOOD CONVERSION WITH EXCELLENT GRAPHICS AND DEFINITELY WORTH THE MONEY."

**The coin-op sensation** that throws you deep into enemy territory with little more than a low-powered, single shot repeater for protection. With superior marksmanship and lightning reactions you can increase the odds - in your favour.

Capture enhanced weaponry, including grenades, and now you can really make your mark! ... that is, until you come face to face with the enemy gunships, tanks and submarines. Equip yourself for some stunning arcade action, load up and **FIRE!!!**

ATARI ST £19.99  
AMIGA £24.99



# GOLDCUT GAMES

FROM DRUG BUSTER TO SAMURAI WARRIOR, US GOLD HAS A GAME FOR EVERYONE

Birmingham-based software company US Gold is preparing to blitz the games playing public with a colossal collection of games due for release between now and Spring. ACE has gone on the road to Birmingham (yes, we're *that* dedicated), taking a sneak look at the forthcoming US Gold line-up...

In the past, USG has suffered a fair amount of criticism concerning the quality of its computer games – particularly with its micro conversions of Sega's *Out Run* for instance. Taking note of this disparagement, USG embarked upon a bold scheme involving the complete reconstruction of its management and software development structures. The result was dramatic. A new-look USG produced two of its most respected games: *Forgotten Worlds* and *Strider*. Now USG plans to surpass these chart-toppers – both in terms of commercial success and technical standards.

David Baxter, Software Development Manager at USG told ACE, "we experienced numerous problems in the past, especially in product quality and control – now we only use software developers that we know and trust."

Surprisingly, USG prefers to use software development companies instead of in-house programmers. The actual USG software development team is organised by Baxter and two other managers, with two games testers giving each game a thorough going-over. But life for these guys can be tough going, as USG has a staggering 160 games formats under development at any one time.

## THE USG SCHEDULE

As well as the prestigious Lucasfilm Games (see *Battle of Britain* and *Loom* previews on pages 133 and 100) and SSI licensed products, USG also has a myriad of coin-op conversions and original games planned. One of the first games due on the release schedule is *Ghouls 'n' Ghosts* – the follow-up to Capcom's phenomenally successful *Ghosts 'n' Goblins* coin-op. *G 'n' G* has been programmed by Software Creations, the guys that brought us the brilliant micro conversions of *Bubble Bobble* and *Bionic Commandos*. Take a look at page

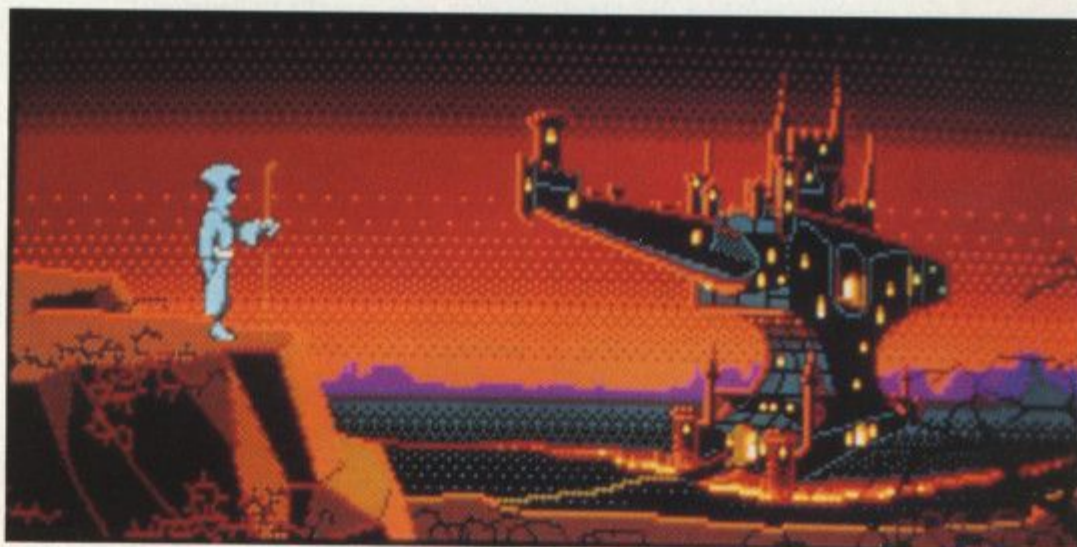

**Loom:** made by Lucasfilms, designed by ex-Infocom Brian Moriarty – see overleaf.

68 to see if we think they've done as good a job with *Ghouls 'n' Ghosts*.

Another Capcom coin-op conversion, *Black Tiger*, is due out next February across all major formats. *BT* has been on the cards for ages – "an absolute age", quips Baxter – in fact it will be approximately 18 months late when it does finally arrive. *BT* is a six level, eight-way scrolling fantasy arcade adventure, with ST and Amiga versions programmed by Graham Lilley (*Heroes of the Lance* and the forthcoming *Dragons of Flame*), C64 *BT* from Softworx and Spectrum and CPC versions converted by Tiertex. Baxter characteristically sums up *BT* as "a big platform jobbie". But behind the *BT* development story there lies a very sad tale, for an 18 year old programmer suffered a nervous breakdown while working on one of the micro conversions. He has now swapped his disk drive for a spanner – working as a trainee mechanic for Ford. Who said programming computer games was easy?

Sega's *Crackdown* coin-op should be out a month later in March – with ARC Developments (*Forgotten Worlds*) handling the micro conversions. *Crackdown* is a simultaneous two-player, 16-level sci-fi exploration

shoot'em-up featuring a slightly-overhead *Gauntlet*-type view. A PC version is planned for May.

Among the other coin-op's licences due are Capcom's *Dynasty Wars* – a six-level simultaneous two-player hack 'n' slash arcade adventure set in Feudal Japan – due sometime in the Summer, Sega's fantasy-epic *Golden Axe* and the horiz-scrolling shoot'em-up *U.N. Squadron* from Capcom. Out of these trio of games, Baxter seems most enthusiastic about *Dynasty Wars*, claiming it to be the most blood-thirsty game he can think of.

## AND THERE'S MORE...

Back in March USG decided to commission a new label solely dedicated to producing original games – mainly on 16-bit formats with console and C64 versions under consideration. The as yet unnamed label has six games due for release over the next six months with a

view for worldwide release instead of USG's more usual European-only approach.

Two of the new original games, *Rotox* and *Sphericule*, are particularly impressive beasts. *Rotox* is being programmed by Binary Design

**Heavy Metal:** an Access (Leaderboard, Beach Head) multi-stage tank-simulation due out on Spectrum, C64, CPC, ST, Amiga and PC in January.





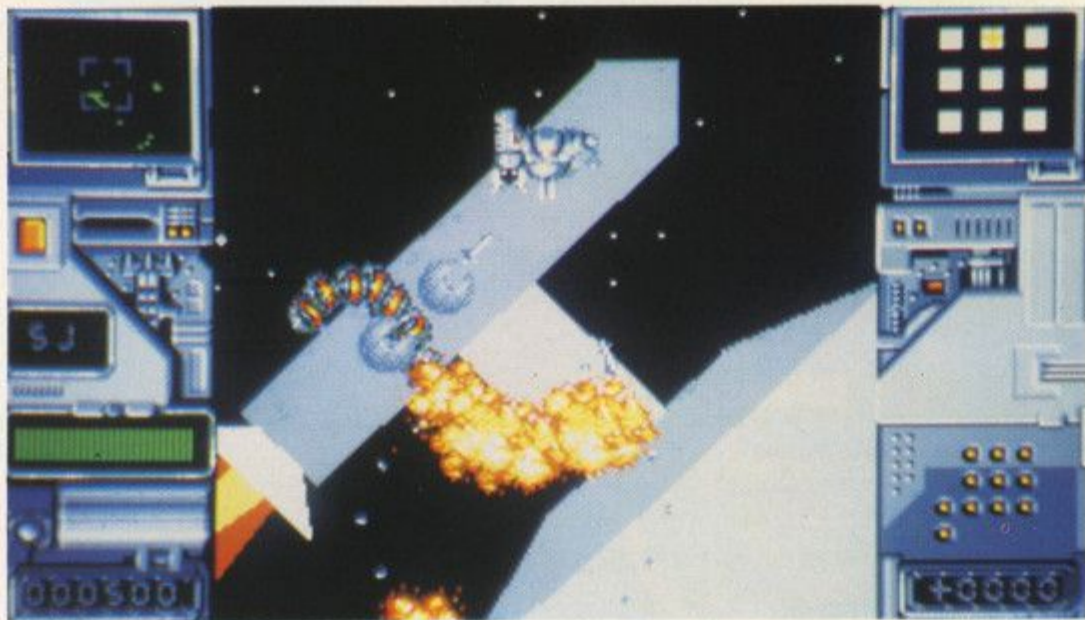

The Rotoscape graphics routines used in *Rotox* took nine months to develop.

and features Rotoscaping – a new programming graphics technique which rotates the whole screen around you. It took Binary Design nine months to develop the Rotoscape code using USG funding. The nearest we've seen to this technique is in the Tengen *Assault* coin-op.

*Sphericule*, on the other hand, is a totally original puzzle arcade game using ray-traced graphics. *Sphericule* may be converted over to the Archimedes, which would bring welcome relief to games starved Archie gamesters.

While on the subject of more exotic USG micro conversions, SAM Coupe gameplayers (if there are any!) will be pleased to hear about the SAM version of *Strider*. Amazingly, it will only take the programmer two weeks to convert *Strider* over to the SAM! Admittedly, the programmer is very experienced – with the Spectrum, CPC and PC conversions of *Strider* already under his belt. The SAM version itself uses ST graphics, Spectrum program logic and will have eight-channel sound. SAM *Strider* should be out anytime now.

Baxter ended our visit to the USG offices with a hint of future plans: "there will be 10 new Capcom games, a licensed (not coin-op) road racing game and another new label using the talents of a single well respected programmer with six original 16-bit only games planned – all due before the end of 1990. And that's just the stuff I can tell you about!"



Animated graphic screens in Sierra style, but with more detailed graphics...

# LOOM

...accompany a story line by Brian Moriarty. Due for release in February '90.

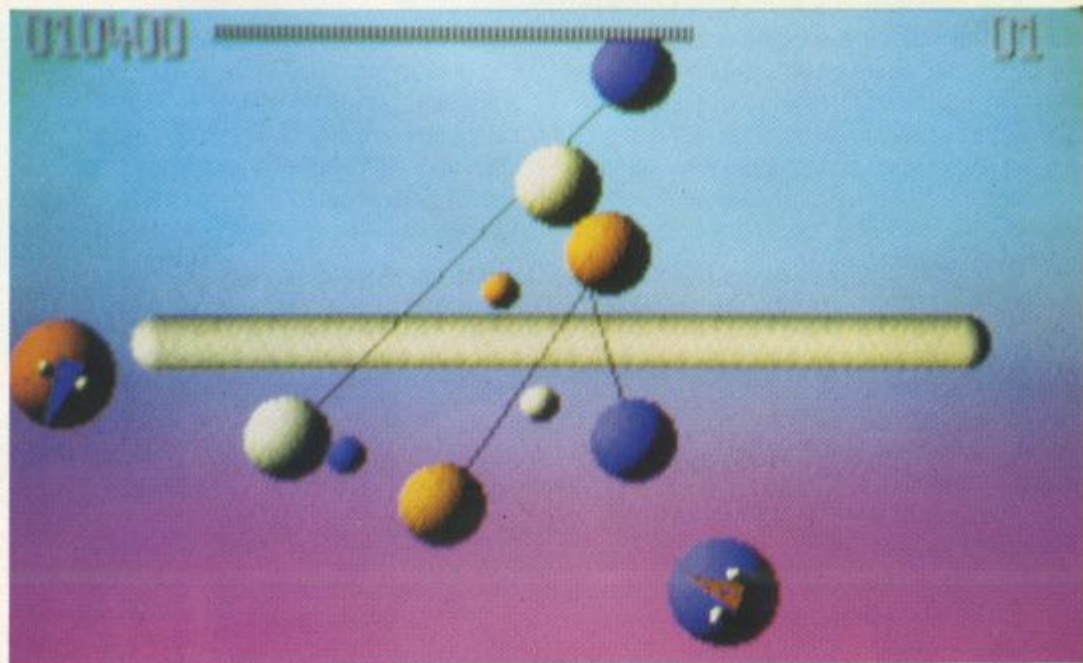

*Sphericule*: "the game that does for particle physics what Einstein did for video games" [Phrase © 1989 David Baxter All Rights Reserved]

## GOLD MOMENTS

We plundered the USG photo-files for a few pics of recent Gold highlights...Award yourself a prize if you can identify them all...



Two infamous games-players, now editors of two of ACE's sister magazines, slog it out. Who? Where? When?



USG's Geoff Brown with three veteran celebrities. What's going on? Who are they?



This twerp helped USG celebrate. What? And who? and (for bonus points) where?

## ANSWERS:

Top pic: the infamous Gary Penn (The One) and Julian Rignall (G&VG) at the Dambusters launch in 1985. Middle: Members of 617 Squadron, also celebrating the launch of Dambusters in 85. Bottom: 'snot-burgling virgin' Rik Mayall celebrating USG's tenth birthday at The Limeight club.



# Player Manager

BY DINO DINI

BRINGS THE QUALITY OF 'KICK OFF' TO THE ART OF MANAGEMENT

- \* Play the BEST soccer simulation. Blistering Pace - Pixel Perfect Passing.
- \* Unique facility to design your own TACTICS.
- \* Over 1000 individual players each with a unique combination of attributes.
- \* A lively transfer market. Haggle for the best deal.
- \* Focus camera on the ball or any player on the field.
- \* Load and Save game facility. League and Cup tournament.

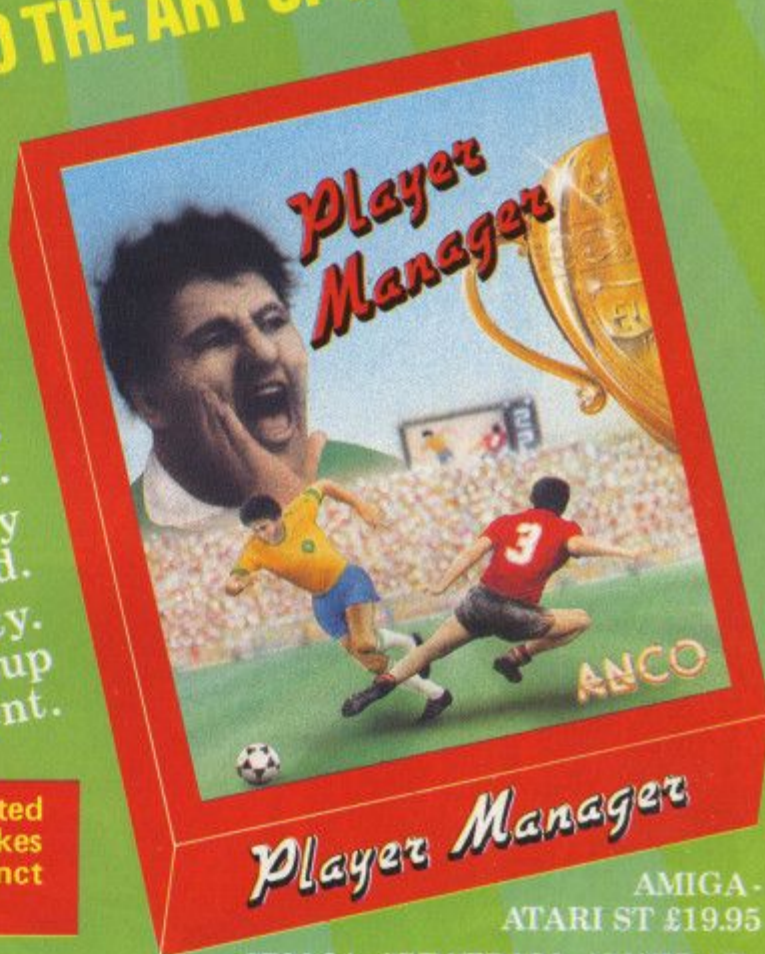

Player Manager

AMIGA - ATARI ST £19.95

CBM 64 - SPECTRUM - AMSTRAD - ATARI 800 £9.95 (Cassette) £14.95 (Disc)

Bring Back The Glory Days, the brief of the newly appointed **PLAYER MANAGER**, an International class player, as he takes charge of a third division club. His success depends on four distinct aspects of the game.

## PLAYING SKILLS OF THE MANAGER

This part of the game is a refined version of the KICK OFF, retaining it's pace, flavour and the universally acclaimed game play. Play in your position or control the nearest player. The first option combined with a tailor made tactics can play havoc in the opposition goal mouth.

## MANAGERIAL SKILLS

Devising winning tactics, acquiring players with right skills from the Transfer market and selecting a well balanced team is the test of his Managerial skills. When to hang his boots up is the toughest decision he has to make.

## TACTICS

Four well proven tactics are provided to suit most situations but you can design your own tactics. See the tactics in action using the Ray Trace facility.

## THE PLAYERS

Over a thousand players in the four division league. Each player with a unique combination of the following attributes: SHOOTING ACCURACY, PASSING ACCURACY, PACE, STAMINA, APPLICATION, AGGRESSION, HEIGHT and TACKLING SKILL.

These attributes are influenced by the player's Age, Mental and Physical Dexterity, Quality of Experience, Weight, Temperament and Morale. There are several other factors such as injury, disciplinary points, unsuitable playing position which influence a player's performance.

Hosts of other factors like referees, injuries, disciplinary problems, team morale etc. can lay to waste the best laid plans of a manager. The **PLAYER MANAGER** brings everyday realities of a Manager's life, his talents as a manager and a player into a sharp FOCUS. THE FOCUS IS ON YOU.



Player Information	
Name	Z. Barnes
Position	Midfield
Age	21
Height	180 cm
Weight	81 Kg
Pace	181
Dexterity	186
Stamina	128
Resilience	149
Temperament	143
Work rate	84
Skills	
Passing	111
Shooting	41
Tackling	60
Keeping	23
Morale	100
History	
This yr.	Last yr.
Injuries	2
Goals	8
Goals	2
Hatches	10
Int. 1st	2nd
3rd	4th
0	0
0	1

ANCO

ANCO SOFTWARE LTD., UNIT 10, BURNHAM TRADING ESTATE, LAWSON ROAD, DARTFORD, KENT. Mail Order by Cheque, Postal Order, ACCESS or VISA. Telephone No.: 0322 92513/92518. FAX No.: 0322 93422.



INCREDIBLE BUT TRUE!

Virgin Games

# THE NINJA WARRIORS™

AN OFFICIALLY APPROVED  
TAITO  
CONVERSION

AMAZING  
1st ISSUE  
DEC 89  
7278070

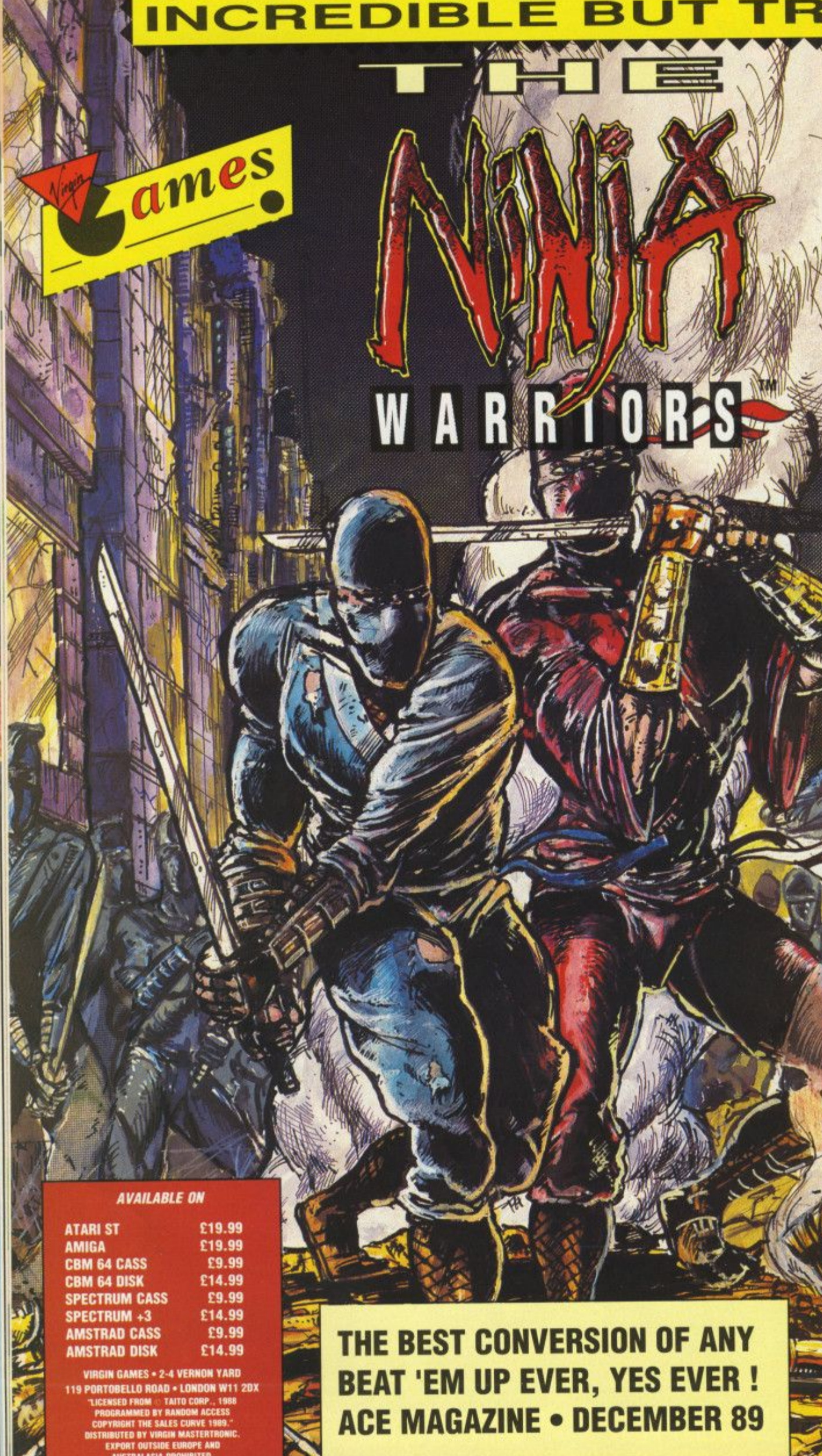

SCORE: 1300 GAME OVER



PAUSED - PRESS P TO CONTINUE

SCORE: 600 SCORE:



00006080



20 00



**AVAILABLE ON**

ATARI ST	£19.99
AMIGA	£19.99
CBM 64 CASS	£9.99
CBM 64 DISK	£14.99
SPECTRUM CASS	£9.99
SPECTRUM +3	£14.99
AMSTRAD CASS	£9.99
AMSTRAD DISK	£14.99

VIRGIN GAMES • 2-4 VERNON YARD  
119 PORTOBELLO ROAD • LONDON W11 2DX  
"LICENSED FROM © TAITO CORP., 1988  
PROGRAMMED BY RANDOM ACCESS  
COPYRIGHT THE SALES CURVE 1989."  
DISTRIBUTED BY VIRGIN MASTERTRONIC.  
EXPORT OUTSIDE EUROPE AND  
AUSTRALASIA PROHIBITED.

THE BEST CONVERSION OF ANY  
BEAT 'EM UP EVER, YES EVER!  
ACE MAGAZINE • DECEMBER 89



# ACE FLASHBACK!

**B**efore 1980 if you had a computer in your house, you would have built it yourself, and you would have thought of yourself as an electronics whiz, not a computer enthusiast. If you had a microcomputer at work, you would be in a specialist, electronics/science-orientated profession, and the micro would in all likelihood be a Commodore PET. Your home computer would have taken days hunched over a hot soldering iron to assemble and you wouldn't be thinking of playing games with it. For that there were dedicated Atari consoles from the States.

And it was in the US where people were buying Apple IIs in hundreds of thousands, and the new Atari 400/800 machines. While the Atari's, like their VCS predecessors, were very much games machines, the Apple IIs were used for serious applications as well for games. American computer users tended to be older, with more money to spend on serious commercial software.

It is more than likely that we in the UK would have gone on to follow the American market slavishly, and rely solely on American imports, were it not for one company - Sinclair Research. The ZX80, which sold to those electronics enthusiasts and the ZX81, which brought home computing to the non-specialist, gave the UK a distinct, 'techie' flavour of its own.

By 1980, it was clear that 'off-the-peg' computers would sell into the home sooner rather than later. Already some of the burning issues of the day bore an uncanny resemblance to debates which will carry on into the nineties. For example, in August 1980, an article in *Personal Computer World* discussed three issues: a) "does existing legislation cover electronic media"; b) "Is digitised pornography on a disk actionable"; c) "what is the correct intellectual property to afford to [software] to protect it from bootleggers and pirates?"

By 1981, Motorola was offering its new 68000 processor as a chip for the 80s, the Z80 and 6502 were already well established, and IBM was introducing its first 8088-based PC. The chances are that your computer uses one of these and yet they are all at least nine years old. What has dramatically changed computers into the colourful, fast, sophisticated machines of today are the advances made in terms of graphic processing, of dedicated graphics and sound chips, such as the early examples in the Commodore 64 to those of the Amiga today. Faster, bigger data storage systems have led to much bigger, multi-level programs. Devices can now be made much smaller: slim-line monitors, disk drives tucked into the keyboard - machines of a size which can be accommodated easily into the home. And finally, memory chip prices have tumbled, so that all the technology that was available in theory eight or nine years ago is now affordable and mass-produced.

More evolution than revolution, really.

## 1980

### ARRIVALS AND DEPARTURES

The Sinclair ZX80 - first shown to the public in February - was the first sub-£100 'computer'. Available for £79.95 in kit form and £99.95 ready-built, the ZX80 was a flat slab of white plastic. Those cooling vents along the top back are actually painted black lines - an optical illusion which was commented on in more than one press review. It had a touch-sensitive keyboard, 1K RAM, an NEC 780-1 processor, which was a 'copy' of the Z80, and built-in Sinclair Basic. Graphics? Not produced until 1981. Sound? Forget it. Software? You had to write it yourself - indeed, that was the whole idea of the ZX80.

Another kit-form computer launched this year was the Acorn Atom, for £125 as a kit and £150 ready-built. The Atom claimed to be 3-5 times faster than Apple Integer BASIC, "and it has the unique feature of including an assembler in the interpreter". But the Acorn Atom boasted graphics as well: a screen with a high resolution of 256 x 192, five graphics modes and 192 graphics characters.

Acorn suffered from production problems with the Atom, so much so that one retailer, described in *Personal Computer World* as the "incorrigible" manager of Lasky's Microdigital chain, announced to all and sundry that he would not include the Atom in his next catalogue because he was too uncertain of receiving any stock from Acorn. That manager's name was Bruce Everiss; the computer industry was to hear quite a bit more from him.

Atari had no UK division in those days; instead the Atari 400/800 machines were imported by Ingersoll,

Get back! ACE storms the Tardis and heads back in time...to an age when yer average sprite came in two colours (black and white), jerked about the screen, and went 'beep beep'.



Frogger  
Interceptor Micros

### Hewson Consultants Founded: 1980

Having worked with mainframes and minis during the seventies, Andrew Hewson was an early buyer of the Sinclair ZX80. He began writing programmes and books for the machine, and advertising them in the few magazines which existed then. Andrew made his name with books of programs for the ZX80, ZX81 and later the Spectrum. Pilot Mike Male wrote three flight sims for the ZX81 before his 1983 program, *Heathrow Air Traffic Control*, and the arcade games written by Steve Turner in 1983-84 - *Space Wars*, *Seiddab* ('baddies' backwards) *Attack* and *Lunattack* - put real money in Hewson's bank. Hewson claims to be the oldest surviving independent games software publisher.

First title: "Hints and Tips for the ZX80" (book), 1980; *Pilot and Night-life* (both ZX81), 1983, both written by Mike Male  
Best ever seller: *Paradroid* (all versions)

Andrew Hewson: Founder of Hewson Consultants





**"The ZX80 really is a complete, powerful, full facility computer, matching or surpassing other personal computers on the market at several times the price. The ZX80 is programmed in Basic and you could use it to do quite literally anything from playing chess to running a power station..."**

Science of Cambridge advertisement, March 1980

at initial prices of £395 for the 16K model 400, £695 for the 48K 800.

### EVENTS

If you visited WH Smith's outlet in Brent Cross Shopping Centre in North London, you could witness a curious 'experiment'. Market development manager John Rowland was putting together the first 'Computer Know-how' unit. A Commodore PET borrowed from a local dealer, a few copies of Byte magazine and a small range of books, "which were actually all about calculators because we couldn't find any computer books," says John, made up the display. The crush of interested customers around the stand was so great that it had to be roped off.

The success of the Brent Cross venture led John to ask Clive Sinclair in September about selling the mail-order only ZX80 in WH Smith. "Clive suggested that rather than take on the ZX80, I should wait for his



**"Microtan 65 - the microcomputer that thinks it's a mini."**  
Advertising slogan from Tangerine Computer Systems



Alice in Videoland  
Audiogenic

new product, then still unnamed," he remembers. "By Christmas 1980, it was officially the ZX81, and we were wrangling over how many units we thought we could sell. We thought somewhere between 15-30,000 would be about right, and gave Clive an order for 18,000 to put in 15 branches. We ended up selling 450,000 - in the two years of the ZX81's life."

The third PCW show moved to the Cunard International Hotel (now the Novotel) in September. This was the last wholly business/hobbyist PCW show, before the games began to take over.

The 'third wave' of arcade games - *Galaxians*, *Scramble*, *Defender*, *Donkey Kong* and *Pacman* - appeared as *Space Invaders* burnt itself out (the 'first wave' of *Ping Pong* and *BreakOut* had taken the arcades by storm in the early to mid-70s). A year or so later, crude variants of these titles formed the raw beginnings of the games we know today.

### PsionFounded: October 1980

Psion was set up by David Potter on leaving the teaching staff of Imperial College, London. By 1981, the company was enjoying considerable success repackaging and marketing software programs for the ZX81: *Flight Simulation* was a huge early seller, followed by *Horace Goes Skiing*. However, Potter's ambitions lay beyond games and after publishing titles on the Spectrum - *Chequered Flag* and *Scrabble* - Psion took on the task of producing the integrated business software for Clive Sinclair's QL machine. It also took time out to produce its consistently highly rated *Psion Chess* program in 1984.

At the same time, work began at Psion on hardware development, work which saw the light of day as the first Organiser handheld computer in 1985. Since then, Psion has concentrated almost exclusively on hardware development. The Organiser and its successor, the Organiser II, were bought in a variety of consumer and OEM configurations, and were followed in September 1989 by the MC - Mobile Computer - range. Psion is, however, unique as a one-time leisure software publisher which has successfully floated on to the USM of the Stock Exchange.

First title: *Flight Simulation*, ZX81  
Best seller: *Psion Chess* (all formats)

### Where are they now? Nolan Bushnell

Nolan Bushnell was the founder of Atari, which he set up as an R&D firm. However, it had diversified into games, when Nolan wrote the commercial video program, *Pong*, back in 1972. (He himself claims his first ever game was a little known number called *Computer Space*.) He released 20 or so more under the Atari banner before selling the company to Warner Communications in 1976. Nolan then set up a company to design and manufacture robots, from simple functional devices to Petsters, a light hearted toy cum robot. Today he also runs coin-op manufacturer Axlon and AAPES, which makes a micro TV board for the Apple Macintosh. All the companies are based in California.

# 1981

### ARRIVALS AND DEPARTURES

The Commodore Vic 20 was shown publicly for the very first time at the January Consumer Electronics show in Las Vegas, and was launched in the UK in June. It wasn't the first colour computer, but it was the first to sell for under \$300, at \$299.95. The Vic 20 had 5K RAM, a full-size keyboard which was later used in the Commodore 64, and its own custom chip, VIC (Video Interface Chip). It went on sell over two million units worldwide over the next three years.

The first UK-produced Vic 20 game appeared in September. Published by Mr Micro at £16, it was entitled *Gold Rush*, and the first person to complete it would win a bag of 22 carat gold.

The Sinclair ZX80 got its first games and Clive Sinclair was reportedly "tickled pink" that programmers had produced graphics on the computer. The program was *Space Intruders* and readers of Tim Hartnell's book *Making the Most of Your ZX80* could either type it in, or order a ready-made tape from Ken MacDonald of Solihull.

In March, the Sinclair ZX81 was announced by the newly rechristened Sinclair Research, and given an ecstatic welcome by computer enthusiasts. Still with just 1K RAM, and still with that flat touch-sensitive keyboard, it was nevertheless a great leap beyond the ZX80, and furthermore, less expensive, at £49.95 in kit form and £69.95 ready built. It had a much lower chip count, thanks to its own custom chip designed by Sinclair and built by Ferranti, it had a much improved screen display, it could produce graphics, it could do floating point arithmetic - in short it was genuinely useful as a computer rather than the electronic assembly exercise which is how buyers tended to treat the ZX80.

The more the market grew, the more it became only a matter of time before the mighty conglomerate IBM launched its microcomputer. The PC may have been behind-hand compared to companies like Apple and Commodore who were forging ahead in the new industry, but its solid, unexciting specification - Intel's 8088 running at 4.77MHz, a single disk drive, 16K RAM, but all expandible - and an equally solid price of

### Who said this - and about what? (answer at the end)

"It marks the beginning of a 'new wave' of personal computers aimed at the home... it's well made, well packaged and would hardly look out of place alongside the family hi-fi."





\$3,000, plus the IBM name ensured plenty of corporate sales.

1981 saw the first of the truly commercial software houses, ie those with full-time staff, proper offices and advertising budgets. Psion, Bug Byte and Quicksilva led the way out of the back bedrooms, the last-named run by Nick Lambert and John Hollis, who later took on a certain Rod Cousens to look after the company finances, and indeed, run the company.

Quicksilva produced the first ever Spectrum game, *Space Intruders* at £5.95, in 1982. Bug Byte spin-off companies such as Software Projects and Imagine went to achieve success of their own (see 1983). Eventually both Bug Byte and Quicksilva went on to become labels of Grand Slam Entertainments, while Psion evolved quite differently.

#### EVENTS

The ZX81 finally made it into W H Smith, the centre piece of a display which included books, magazines and software. The demand was so staggering that WH Smith had to put 500 staff on a crash course to train

them to switch it on and run a small program to demonstrate the machine to customers. This was the computer's first real entry into the high street multiples, and it gave home computing some much needed credibility as a leisure pursuit.

On September 26, the first ZX Microfair threw open its doors to the public. Held at the Central Hall in Westminster it was attended by several hundred Sinclair devotees. Entry was free of charge. Over in the US, Infocom launched the first *Zork* adventure for the Apple II.

#### STORIES

Sinclair suffered its first serious setback when the ZX81 was rejected by the BBC. Initially, the BBC had selected the Newbury Electronics' NewBrain as the nucleus of its forthcoming series on computing; this machine had started life as a Sinclair Radionics project in 1978. Newbury, rather to everyone's surprise, turned the BBC down and the way was left clear for Acorn headed by ex-Sinclair employee Chris Curry, promoting the Atom successor, the Proton, and Sinclair itself, pushing the successor to the ZX81, to compete for the contract.

There simply isn't space here to detail all the backstabbing, foot-shooting and press speculation that accompanied the award of the BBC contract. As everyone knows, the BBC chose Acorn, and the Proton became the BBC Model A micro.

#### Where are they now? John Hollis/Nick Lambert

In 1984, Argus Press Software bought Quicksilva, a deal which made Lambert and Hollis wealthy enough to warrant tax exile. Both moved to Guernsey, where Hollis still is, with his own company Hollis Research. Hardly idle though - he wrote the ST game, *Trackman*. Nick Lambert is now back in Southampton. Co-Quicksilva shareholder Rod Cousens set up Electric Dreams Software in September 1985, which later became an affiliate of Activision.

# 1982

#### ARRIVALS AND DEPARTURES

Everyone wanted to jump on to the home computer bandwagon in 1982. The Sinclair ZX Spectrum, launched in April, led the pack and heralded the beginning of games computing in the UK. Those machines that followed in its wake had nothing like the brand loyalty that Sinclair had built up from ZX81 days; and most did not noticeably improve on Sinclair's appalling disregard for production schedules.

In comparison, the Commodore 64 could have come from another planet. Its specification, which doesn't look too terrible today, was way ahead of its time, and made visitors to the Third International Commodore Computer show in June, where it was previewed, gasp in astonishment. The 64K memory really was huge at that time, its proper keyboard compared very favourably with the rubber-keyed Spectrum, it had 16 colours and no attribute clash problem, as the Spectrum did, sprite graphics, a 40 column screen and the SID - Sound Interface Chip - built in. But, to begin with, you paid for all that mighty technology: the C64 was launched at £350 at the end of 1982. And no C2N, joysticks or software included, either.

In the UK the Commodore quickly joined the Spectrum as a first choice computer for buyers, without ever outselling it. In the rest of the world it was a dif-

**"We hope to produce at least two new games each month - and all our software will be original rather than versions of existing arcade games."**

David Lawson, Imagine Software  
(Popular Computing Weekly, January 6, 1983)

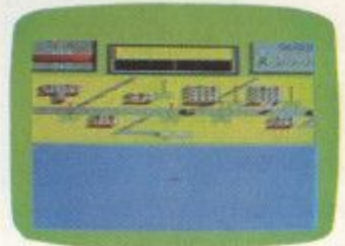

Falcon Patrol  
Vigin Games

**"We designed the Apple II with six guys and it's about to become the most-installed computer of all time. We designed the Apple III with a corporation of 1600 and it still doesn't work."**

Steve Jobs

#### CDS Founded: 1982

In the best British traditions, Ian Williams began by programming for the ZX81 in his back bedroom, notably a game called *Castle Adventure*. To put the operation on a commercial footing, he took the programs along to his local WH Smith, where the branch manager, Giles Hunter, took such an increasing interest in Ian's CDS Micro Systems that he joined the company as sales manager in July 1983. In December 1983, CDS opened its first shop, in Doncaster - there are now 12 - and a few months later Giles bought Ian Williams out. CDS now employs over 100 people, with interests in full-price and budget software, retailing, distribution, tape and disk duplication, packaging and printing.

First title: *Castle Adventure*, ZX81

Best ever seller: *Colossus Chess*, closely followed by *Steve Davis Snooker* (all versions)

ferent story. The C64 became the world's best-selling computer; in the US it cleaned up. Aggressive price cutting by Commodore, headed by Jack Tramiel, led to a price war and near financial ruin for rival Atari. The Dragon 32, was launched in July and sold in Boots on terms similar to WH Smith's exclusive contract with the Spectrum. Its 32K RAM, graphics and Basic all compared favourably to Sir Clive's beast. The NewBrain, finally saw the light of day, produced by Grundy Business Systems, which had bought the project from Newbury Electronics.

The first Japanese home computer to be sold in the UK was the Sord M5, which was really a computer/console hybrid. And let's hear it for the Oric 1, bugs and all, rubber key board and 16K RAM. The Lynx was a Z80-based machine, with some impressively large memory configurations and high resolution graphics, which simply never made it into the high street stores in great enough number to sell. Finally, there was the curious Jupiter Ace, developed by Steven Vickers and Richard Altwasser, who had both been on the Sinclair Spectrum design team. It was another Z80 derivative machine, which is chiefly remembered today as the only home computer to sport Forth as its in-built language. This proved to be its downfall.

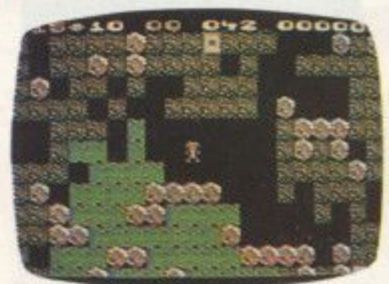

Hobbit  
Melbourne House

**"He's done it again. Uncle Clive has come up with a lovely product which will have enormous appeal to people wanting to find out more about computers but without it costing them an arm and a leg."**

David Tebbutt, Personal Computer  
World; June 1981



**"Our Microdrive, when it comes out, will revolutionise mass storage thinking."**

Martin Brennan, Sinclair Research  
(Popular Computing Weekly, November 18, 1982)

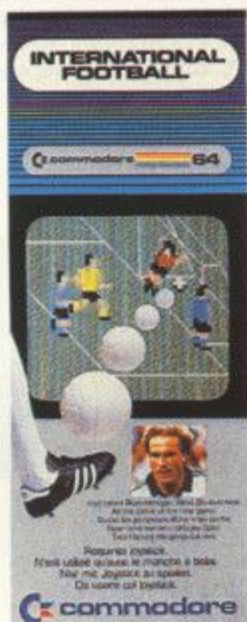

International Football  
Commodore

### Who said this - and about what?

"It will have appeal as a games machine because of its very high speed and because the language allows such sophisticated user-defined graphics."



Galaxy  
Anirog

### Virgin/Mastertronic Virgin Games Founded: February 1983

No romantic back bedroom tales here. Virgin Games, set up by Nick Alexander, was a natural expansion for Richard Branson's 13 year old record company, and was set up in a blaze of publicity. The quality of its programs noticeably improved after Virgin set up an in-house programming team, the Gang of Five, in 1984. In 1986, Virgin Games bought out Leisure Genius and its range of licensed board game conversions, and in October 1987, it acquired a stake in Mastertronic, the pioneer budget software house. The takeover was completed a year later to form a new company, Virgin/Mastertronic. The involvement with Mastertronic gave Virgin its first entree into hardware, becoming the sole distributors of the Sega games console range in the UK in November 1987.

First title: after an initial batch of eight titles which were relatively unsuccessful, *Falcon Patrol* was the company's first hit

Best ever seller: *Sorcery* (all formats), by the Gang of Five

### Digital Integration Founded: February 1982

Dave Marshall and Rod Swift, like so many others at the time, developed their first program, *Fighter Pilot*, in their leisure time, transferring skills learnt at the Royal Aircraft Establishment on to the ZX81. Dave now describes *Fighter Pilot* as 'rudimentary'; it was *Night Gunner* on the ZX81 which, with sales of over 10,000 through WH Smith, enabled the company to set up on a commercial basis. Both *Fighter Pilot* and *Night Gunner* were converted on to the Spectrum in 1983, and Dave and Rod gave up their jobs to go full-time at DI.

First title: *Fighter Pilot*, ZX81

Best ever seller: *Fighter Pilot*, all versions

### EVENTS

In November, Sony launched the 3.5 inch disk drive in the UK. Those of you with 1.44Mb versions may care to note that Sony's original single density drives stored 218K, the double density a 'massive' 437K. Starting price was £235.

January - and the second ZX Microfair. Bursting at the seams with arcade clones, visitors could try out and buy ZX81 titles such as *Invaders* and *1K Break-Out* from flourishing Liverpool publisher Bug Byte, *Defender*, *Invaders*, *QS Scramble*, *Asteroids* and *Galaxians* from Quicksilver, *Monkey Bizness* from Artic, or *3D Monster Maze* from J Graye Software. No prizes for guessing which of these were based on *Space Invaders*, *Pacman*, *Galaxians*, *Scramble* and *Defender*.



# 1983

### ARRIVALS AND DEPARTURES

Plenty of new micros lined up at the starting blocks in 1983. The Acorn Electron was announced in January with a scheduled release date in March. It finally rolled out of Acorn over a year later. In May, Memotech, previously a Spectrum alternative keyboard supplier,

showed off its Z80-based micro, the Memotech MTX. Mattel announced that the age of its Aquarius would dawn in September. IBM dipped a corporate toe into the home computer market with the PC Jr, 128K RAM and a 5.25" disk drive for \$1269. The Coleco Adam was dubbed the 'star' of June's Consumer Electronics show in Chicago, but by Christmas, Coleco was having so many problems with shortages and reports of faulty machines, that it was glad to have the Cabbage Patch doll to fall back on.

A game called *Valhalla* caught everyone's imagination. Publisher Legend Software claimed it was the "first computer movie", a Norse scenario peopled with 'independent' characters in which the outcome could be different every time. And at £14.95, it was a nice little earner for Legend.

In 1983, software, which had hitherto been dominated by unofficial versions of arcade games, began to diversify. Adventure games like *The Hobbit*, by Melbourne House, and Level 9's *Colossal Adventure* and *Snowball* had significantly improved parsers. Gilsoft's *Quill* became available towards the end of 1983, and

### Where are they now? Commodore Max, Ultimax and Vic 10

Actually these are all one and the same computer, intended as successors to the Vic 20 in the starter computer market. All three incarnations were announced and previewed at shows. The Ultimax version was notable for offering a flat membrane keyboard like that of the ZX81, while the Commodore Max (the latest version) had 2K RAM, and could produce 16 colours on a 320 x 200 screen. It never arrived, and was shortly superseded by prototypes of a 116 and 264, which eventually became the C16 and Plus/4.

led to a thriving cottage industry of 'homemade' adventures. It was a good time for UK adventure writers, since Infocom titles, such as the famous *Zork* series, and adventures by Scott Adams, were not easily available in the UK, and certainly weren't converted for any home-grown machines like the Spectrum.

### EVENTS

The PCW show was again at the Barbican, and was the first of the all-screaming whizz-bang games-fests that became the PCW show of the late 80s. Star turns by Imagine and Llamasoft.

Bug Byte, one of the largest and most well-known of the software houses which had grown up around the ZX81 and Spectrum, was going through turbulent times. In January, its head programmer Eugene Evans, and senior staff David Lawson and Mark Butler broke away from the company to form Imagine Software, and its first game, *Arcadia*, for the Spectrum and Vic.

### Mirrorsoft Founded: November 1983/June 1985

Although Mirrorsoft was set up by Mirror Newspapers' development manager Jim Mackonochie as a feasibility project in November 1983, it did not become a company in its own right until June 1985. Early titles included such educational gems as *Caesar the Cat*, *First Steps with the Mr Men* and *Quick Thinking* (early 1984). *Spitfire 40* was published in Spring 1984 ("I remember the date very clearly, because I spent Easter Monday at the duplicators, desperately trying to fix a bug in it," says Jim).

Mirrorsoft trundled along with neither big hits nor too many grand disasters until it began to make a speciality of the growing 16-bit market in 1987, using its Cinemaware licence as a springboard. The Mirror Group bought US companies FTL and Spectrum Holobyte (now up for sale again) to add to its software stable, while Mirrorsoft created a new games label, Image Works.

First title: *Game Creator*, 1983 (written by the then teenagers, David and Richard Darling)

Best ever seller: *Falcon* (all versions)



ech MTX.  
ius would  
e toe into  
28K RAM  
co Adam  
electronics  
was hav-  
ports of  
Cabbage

imagina-  
was the  
pled with  
me could  
as a nice

en domi-  
s, began  
t, by Mel-  
ture and  
Gilsoff's  
983, and

nd

ended as  
All three  
The Ulti-  
keyboard  
atest ver-  
20 x 200  
by proto-  
C16 and

remade'  
ure writ-  
us Zork  
not easi-  
nverted  
m.

and was  
es-fests  
tar turns  
ll-known  
around  
urbulent  
e Evans,  
er broke  
oftware,  
nd Vic

ne

develop-  
ject in  
wn right  
ems as  
hinking  
remem-  
y at the

o many  
growing  
spring-  
d Spec-  
are sta-  
orks.  
nagers.

20, became available shortly after-  
ward. At first, it appeared that  
Imagine could do no wrong. Arca-  
dia sold strongly and the company  
presented a flamboyant, affluent  
lifestyle. It appointed Bruce  
Everiss, that "incorrigible"  
Microdigital boss from 1980, to  
head its marketing, there were  
tales of fast cars and fast  
lifestyles, and Imagine finished  
1983 on a high. In November, Bug  
Byte lost its second batch of per-  
sonnel when Alan Maton and  
Matthew Smith, programmer of the  
hit *Manic Miner*, left to form Soft-  
ware Projects, Smith with the  
*Manic Miner* sequel underway.

Atari US axed nearly a quarter  
of its total staff - about 1,700 peo-  
ple - after posting "disastrous"  
financial results, despite announc-  
ing a new 1200XL computer with  
64K RAM, and cutting the price of  
the 800XL from £499.95 to  
£399.99. By the end of the year,  
Warner Communications was look-  
ing for a buyer for the ailing  
games company.

Clive Sinclair, 42 years old,  
was named *The Guardian Young*



**Boulder Dash**  
First Star Software

### Who said this - and to whom?

"Are you going to sell sugered water  
to children all your life when you  
could be doing something really  
important?"

### Where are they now? Eugene Evans

Helped develop *The Bermuda Project* for Mirrorsoft in 1987, before moving into project management rather than programming. Now lives and works in the US. Joined Icon Simulations in Chicago a year ago; company has produced *Deja Vu*, *Uninvited* and *Shadowgate*, published in UK by Mirrorsoft.

*Businessman of the Year* in March.  
In June, he received a knighthood  
in the Queen's Birthday Honours.

### STORIES

In the summer, Samurai Comput-  
ers changed its name to Elan Comput-  
ers, and sparked off one of  
home computing's longest running  
sagas of missed release dates,  
name changes and confusion with  
the ever-entertaining tale of the  
Enterprise.

The Elan Enterprise, we were  
told would be a computer "with  
obsolescence built out". Dedicated  
chips handling graphics and sound  
(the 'Nick' and 'Dave' chips, if you  
will), large memory, expansion  
potential, the Enterprise had it all...  
on paper. When it eventually  
appeared at the end of 1984, it  
was maybe not obsolete, but cer-  
tainly nothing groundbreaking any  
more.

**"The Microdrive should have a  
major impact on the Spectrum  
software market, not only for  
games, but for sophisticated  
personal/business software  
like spreadsheets or database  
applications."**

Personal Computer News, August 4

### Acknowledgement

Many thanks to David Tebbutt, and  
David Kelly, for their help and for let-  
ting me rummage through their  
respective magazine collections.

### ANSWERS

P.34 1980: Personal Computer World, May 1980, in a review of Texas Instruments' T199/4 computer.

P.32 1982: Richard Altwasser of Jupiter Cantab, about the Jupiter Ace (Popular Computing Weekly, November 18, 1982)

P.35 1983: Steve Jobs, co-founder of Apple Computer, to John Sculley, then of Pepsi Co. Generally credited as the remark which persuaded Sculley to join Apple as president. Sculley later sacked Jobs.

# SOCCER MATCH

# IMPRESSIONS

**FREE  
WIN A TRIP  
TO ANFIELD**

**OUT IN OCTOBER  
ON ATARI ST  
CBM AMIGA**



# IMPRESSIONS







**"TAKE NO PRISONERS, GIVE NO  
QUARTER, MAKE NO  
COMPROMISES"**

# X OUT™

"X Out is not simply a game, more a multi-sensory assault – the first of a 'new wave' in software development that not only restates the principles of games programming, but then transforms the expectations of the new generation of games players. Computer entertainment developed on the computer for the computer."

From the farthest reaches of outer space, they came to inhabit the depths of our oceans. From their savage assaults on a defenceless human race, grew a planet's last desperate crusade – project Deep Star, the ultimate underwater war machine. Early encounters proved catastrophically ineffective, however a few kept faith, all the time improving Deep Star, the greatest collection of man's technical wizardry, committed to the hands of a lone gladiator for one final attempt at halting the inevitable – the frantic death throes of a civilisation sinking into darkness.

That gladiator's battle cry ... take no prisoners, give no quarter, make no compromise.

- **Strategic underwater action.**
- **Over 50 simultaneous 'on screen' objects.**
- **48 colour graphics.**
- **50 pics per second scrolling.**
- **8 levels each 160 screens.**
- **40 different aliens.**
- **Multi graphics styles incl. lava, fire, crystal.**
- **"Buy and sell" over 25 multi functional extra weapons.**
- **Free style configuring of weapons and satellites.**



**Rainbow  
Arts**

CBM 64/128 & Amstrad CPC  
£9.99 tape, £14.99 disk  
Spectrum  
£8.99 tape, £12.99 disk  
Atari ST & Amiga – £19.99 disk



# BETRAYAL

A web of intricate possibilities  
but fair play isn't one of them.

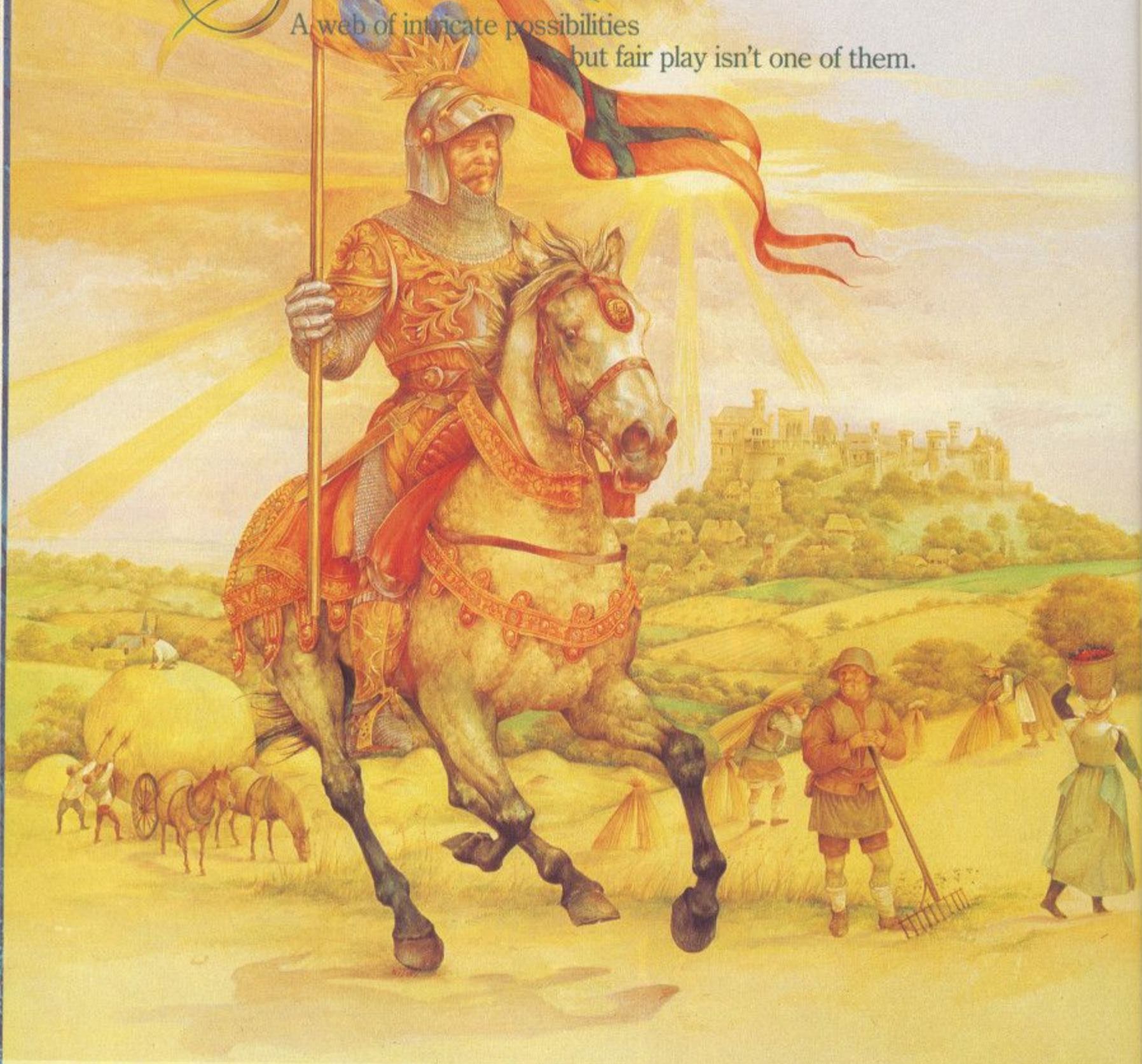

**In the pursuit of power, the end justifies the means . . .**

Your opponents will betray you. They will cheat, lie, pillage and kill – and try to blame you if they are caught! They will plot and spy against you in a fight for raw power and wealth.

Betrayal involves a long, hard, ruthless struggle, starting with the acquisition of towns, cultivation of your lands and culminating in the

honing of your military strategy and execution of political subterfuge.

Betrayal is available now for your ST and Amiga at £24.99, C64 and Spectrum cassette at £9.99, and C64 and Spectrum disk at £14.99, and PC at £24.99.



© 1989 Floppy Electronic Services Ltd. MASTER OF STRATEGY

Unit 1, Hampton Road Industrial Estate, Tetbury, Glos. GL8 8DA. Tel: 0666 504326/504412



# THEIR FINEST HOUR



## The Battle of Britain

ACE trips the flight fantastic with Lucasfilm's latest historic air combat simulation...

**S**ummer 1940: the future of Britain lies in the hands of a few idealistic, young, but very brave RAF fighter pilots equipped with just 530 fighters up against the might of Hitler's Luftwaffe with over 2030 aircraft. Given the choice which side would you have gone for? Well, with this new Lucasfilm historic flight-simulation you have just that choice, and the chance to fly eight classic aircraft from the period. You could even alter the outcome of the Battle of Britain if you're good enough!

### FLIGHT OF FANCY

*Their Finest Hour: The Battle of Britain* is a classy product from start to finish. The PC version comes



"If the British Empire and its commonwealth last for a thousand years, men will still say: 'This was their finest hour!'"

Winston Churchill, 1940

on four disks with a staggering – and extremely impressive – 200-odd page manual detailing everything you could possibly want to know about the Battle of Britain – the Lucasfilm game and the real thing.

On loading, you're presented with a menu selection screen detailing the game's options: training flight, combat flight, custom mission, play campaign, review combat records, review combat film or exit. Training flight lets you practise flying, shooting and bombing in various situations. Combat flight throws you into one of a possible eight historically-accurate missions for each of the eight aircraft included in the game. If you get bored with the preselected assignments, you can build your own missions using the Mission Builder utility included with the package. Play campaign allows you to take part in several campaign missions. You can also review the combat records of the pilots and crews who have flown on

RELEASE BOX		
ATARI ST	£24.99dk	FEBRUARY
AMIGA	£24.99dk	FEBRUARY
IBM PC	£24.99dk	FEBRUARY

### THEIR FINEST HOUR: THE BATTLE OF BRITAIN

Continuing the historic theme first shown in its earlier *Battlehawks 1942* air combat simulation, Lucasfilm has produced a superb flight-sim in *Their Finest Hour: The Battle of Britain*. Although the control mechanisms aren't that responsive and the PC graphics are slightly jerky, the sheer fun of playing through the numerous captivating missions and the chance to fly eight classic aircraft make this game an attractive purchase for any budding ace.

ACE RATING 933

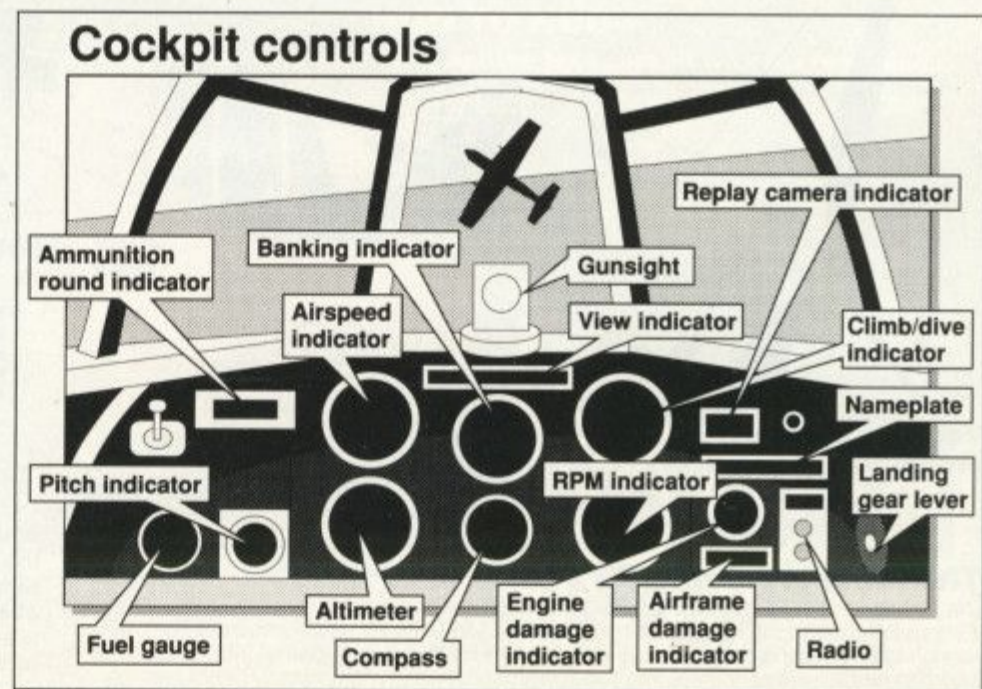



THE HEROES



Douglas Bader

Bader tragically lost both legs after a plane crash in 1931. However, this handicap didn't prevent him from flying again. From July 1940 to August 1941 Bader chalked up 22 kills until he was shot down over France. Bader spent the rest of the war in German prison camps.



Ernst Udet

Ernst Udet was a brilliant WWI ace with 62 kills. After WWI he became a stunt pilot able to use his wing tip to pluck a handkerchief from the ground. Udet joined the Luftwaffe as a chief test pilot in 1935. After the Battle of Britain Udet's reputation rapidly deteriorated and he committed suicide on November 17th, 1941.

your missions, and review the combat film which you can "shoot" during every mission.

PLANE SAILING

*Their Finest Hour* lets you fly eight single-seat fighters, double-seat fighters and dive bombers, and medium bombers: Spitfire, Hurricane, Messerschmitt Bf109, Messerschmitt Bf110, Junkers Ju87 Stuka, Junkers Ju88, Dornier 17 Flying Pencil or Heinkel 111 Spade. Each aircraft has its own characteristics, advantages and disadvantages but the general control methods remain the same for all eight.

Easily the most powerful in-flight control feature is the review combat film option. During a mission, you can switch a camera on and record the ensuing action onto "film". You can then playback the results just like a VCR using a comprehensive variety of view modes from the ground, air or even a bomb!

LUCASFILM'S FINEST HOUR

The ACE team are well impressed with this one - it has everything you could possibly want: authenticity, character and most importantly playability and addictiveness. Whether you're a flight-sim fan or not, you can still gain a great deal of absorbing enjoyment from scrambling a Squadron, taking out a few Hun over the English Channel, while managing to return in time for four o'clock tea at Mrs Miggins pie-shop. It's great in-flight entertainment. Check it out.

THE RIGHT STUFF

After a dogfight over the English Channel, Pilot Officer Tony Woods-Scawen was forced to crash-land his Hurricane on the Isle of Wight, knocking out his front teeth in the process. He then caught a ferry to Southampton, but arrived too late to rejoin his Squadron. He made his way to a bar in a Southampton hotel, had a few drinks and spent the night. The next morning he telephoned his Squadron and told the adjutant, "If you want me to go on fighting, you'd better send someone down here to pay my bill".

REMEMBERING THE FEW

This year sees the Battle of Britain 50th Anniversary Appeal dedicated to helping WWII RAF personnel and their families - they've a target set for collecting £20 million. If you want to get involved or make a donation contact: The RAF Benevolent Fund's Battle of Britain 50th Anniversary Appeal Limited, 51 Grosvenor Street, London W1X 9FH. Tel: 01 495 2657.

"Never was so much owed by so many to so few." Winston Churchill

### Turning inside the enemy

When attacked, German aircraft frequently resorted to flying in a 'defensive circle'. If the attacking fighter could turn inside this circle he could bring his guns to bear whilst being in no danger of being fired upon himself.

World War II fighter aircraft

During the 1930s a new generation of warplanes was developed, moving away from the wood and wire biplanes of the First World War and making use of flush-riveted metal stressed skin monocoque construction, retractable undercarriages and enclosed cockpits.

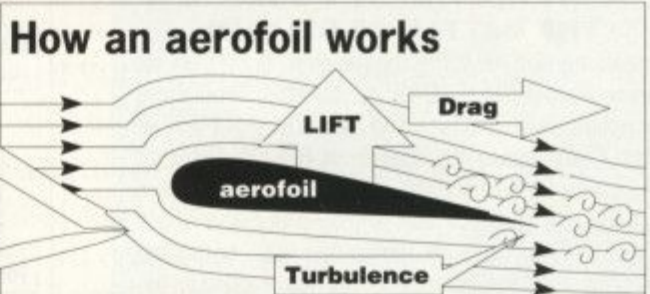
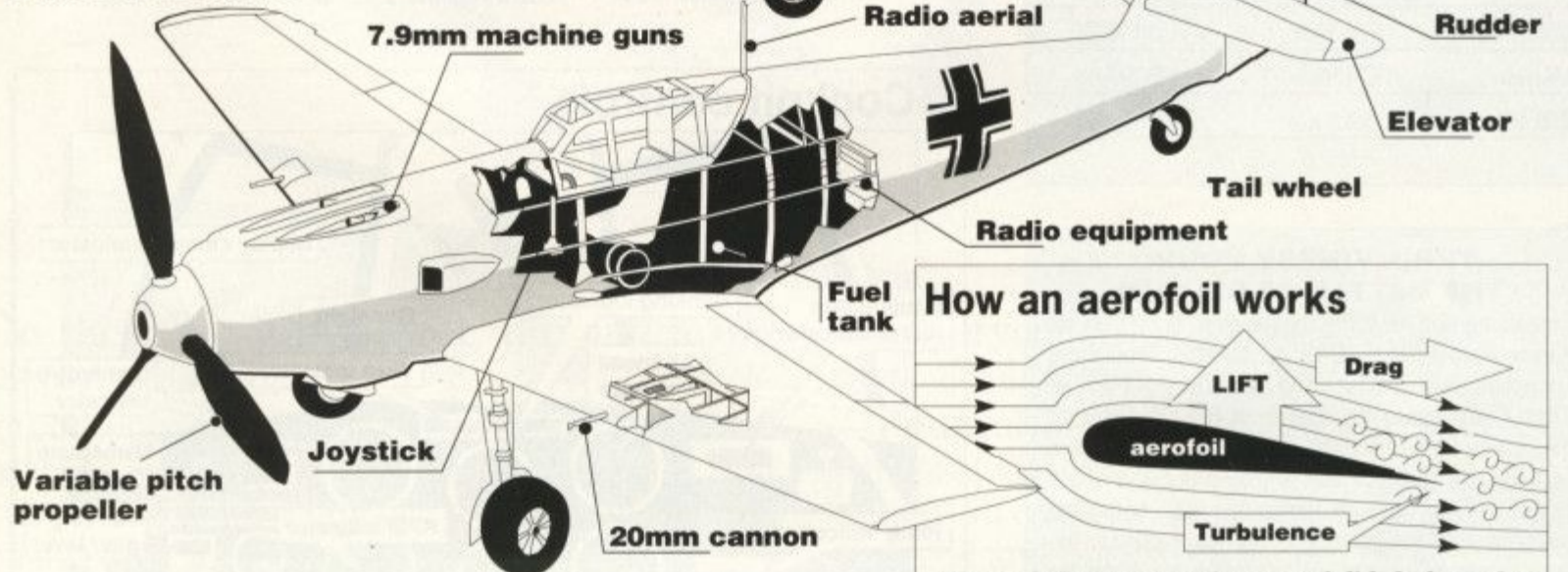

The Messerschmitt Bf 109

The first prototype Bf 109 flew in May 1935 and was powered by a Rolls Royce Kestrel V engine, although the full production version used German made engines. The 109E-3 version had a maximum speed of 348mph at 14,560ft, a wing span of 9.87m and was 8.64m in length. It was armed with two 7.9mm machine guns and two 20mm cannon.



## Attack on Middle Wallop: The ACE Photo-Story



We go to intercept the Ju 88 but are instead attacked by the Bf109 - which we then turn our attention to...

After firing a volley at us, the Bf109 banks towards the sun in a classic manoeuvre



...let's get that shot from another angle!



### BLACK THURSDAY

On August 15th, 1940 a group of Junkers Ju 88s from I/LG 1 used a low-level approach to attack the airfield at Middle Wallop. They arrived so unexpectedly they surprised and all but wiped out 2 British Squadrons on the ground. Only a few Spitfires of 609 Squadron managed to make it airborne while bombs were exploding behind them in the hangars. The day was named "Black Thursday".

While taxiing our Spitfire on the Middle Wallop airfield runway we come under attack from a German Ju 88 medium bomber and Bf109 fighter



Meanwhile, the Ju 88 makes a bombing run on the airfield...



Thankfully the Ju 88 misses its target

We catch up with the Ju 88 and let him have it!

### HUD TO HUD

Compare the Lucasfilm view from a Spitfire Mk I cockpit with the real thing...



### THE LEADERS



Hugh Dowding  
- RAF Air Chief Marshal

Dowding, a professional serviceman since WWI, was the controversial leader of the RAF during the Battle of Britain. Despite being the central driving force behind the winning RAF campaign, "Stuff" Dowding was too unconventional a leader for the British top brass, and was subsequently relieved of command on November 25, 1940 - he left the RAF two years later.



Hermann Goering  
- Luftwaffe Reichsmarschall

Goering was a WWI flying ace credited with 22 victories and a Blue Max medal for valour. He joined the Nazis in 1922, going on to create the Gestapo, organise Hitler's stormtroopers, set-up the evil concentration camps and head the Luftwaffe. Goering lost Hitler's favours after losing the Battle of Britain and Russian Invasion campaigns, and was eventually captured by the Allies on May 8th, 1945. He later committed suicide after being sentenced to death during the Nuremberg trials.



# 13 ACE ISSUES



- Get one extra issue **free** – our last offer was for 12!
- **Don't queue** for your copy, receive it through the post for the next 13 months

- 13 issues from your newsagent **would cost £19.50**
- Get the quarterly update of extra special savings on software from Ace – "The Magazine of the Year"

**Guarantee**  
If you aren't completely satisfied with your subscription, you may cancel and receive a prompt refund for all unmailed copies.

## INSTEAD OF 12 FOR JUST £17.95

6 month subscription £9.95 ● 24 month subscription £31.95

Overseas subscriptions(12 months) Air Mail Europe £42.95 ● Surface Europe and World £27.95

**SEE ORDER FORM ON PAGE 160 OR CALL 0733 555161**



PTION

S

m your  
would

terly  
ra  
gs on  
n Ace -  
ne of



TM

**BATMAN** is a shadow in the darkness, as elusive as a dream. High above the seamy streets of GOTHAM, he is a criminal's nightmare. The only hope for a desperate city — **BATMAN.**



M & © 1964 DC Comics Inc.

Ocean Software Limited - 6 Central Square, Manchester - M2 5NS  
Telephone: 061 832 6633 · Telex: 669977 OCEANS G · Fax: 061 834 0650





**SUPERB  
FREE 'T' SHIRT**

**ENCLOSED IN  
EVERY GAME**

**ORIGINAL  
UNIQUE ROGER DEAN  
DESIGN**

## THE BEAST IS AMONG US

This is it - A whole new dimension in computer games  
 50 frames per second arcade quality scroll  
 350 screens - 132 unique monsters  
 13 levels of parallax scrolling  
 900K of emotive music  
 2Mb of graphics compressed in two disks.

A TRULY MASSIVE GAME FOR THE AMIGA 500, 1000 & 2000

**PSYGNOSIS - GAMES PEOPLE PLAY**

Screen Shots from the Amiga version

AMIGA £34.95/ATARI ST COMING SOON

S  
 The  
 tool  
 The  
 after  
 this  
 time  
 F  
 tastic  
 good  
 to pa  
 drink  
 boys  
 there  
 getti  
 easy  
 start  
 here  
 of yo  
 take  
 part  
 curv  
 itsel  
 just  
 you  
 spl  
 don  
 F15  
 of th  
 exa  
 tech  
 T  
 PIC  
 This  
 ACE  
 char  
 a ga  
 peric  
 acco  
 to ex  
 it is  
 Curv  
 page  
 Each  
 spec  
 give  
 gam  
 spe  
 box  
 GR  
 All a  
 grap  
 of e  
 acc  
 Spe  
 fore  
 ave  
 AU  
 The  
 are



# SCREEN TEST

## PIC CURVE POWER

The PIC – Predicted Interest Curve – is the most sophisticated reviewing tool around. Here's why...

The curve is divided into six sections, indicating the player's adrenalin level after one minute, one hour, one day, one week, one month, and one year. But this tells you an awful lot more than just what your interest level will be at any given time (although that's obviously important in itself)...

For example, a high one minute rating means that the game must look fantastic and get you all excited from the word go. That means it's probably a good game to show off to the neighbours – after all, they probably aren't going to pay attention for much more than a minute, after which they'll go back to drinking coffee and making rude remarks about 'those awful hostile games the boys play these days'.

The minute, hour, and day ratings can tell you a lot about a game too. If there's a dip here, followed by a rise, you've got a game that may take a bit of getting into – not recommended if you like to get down to something quick and easy. Alternatively, the graphics may put you off for a while until the gameplay starts to grip. Check out the PIC comment for more details.

Finally, you've got the month and year ratings. The better a game holds up here the more deserving it is of your hard earned cash.

PIC curve construction takes a lot of playing on the part of ACE reviewers. PIC curve analysis is an art in itself. The reward is knowing just what you're getting when you make the decision to splash out on *Mutant Macdonald Gettysburgers...* or *F15 Strike Eagle II* – just one of this month's excellent examples of today's software technology.

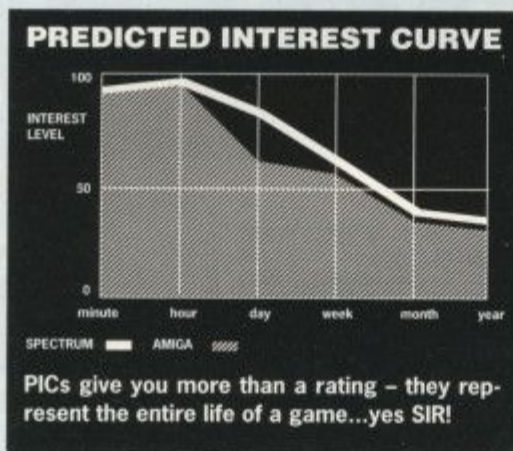

Silhouettes display in System 3's *Myth*. Who ever said that was dead needs to think again.

## DON'T FORGET THE UPDATES!

*Pictionary* hits three new formats, plus *Fiendish Freddie* and *Continental Circus* on the ST and Psygnosis' attractive ball-blasters on the PC. Check out p.123/4.

# THE ACE REVIEWING SYSTEM

### PIC CURVES

This unique feature to the ACE reviewing system charts the interest level that a game stimulates over a period of time. The curve is accompanied by a comment to explain why it's the shape it is. Find out more in the Pic Curve Power panel on this page...

Each review also carries special 'Version Boxes' that give you details of the game's implementation on a specific machine. These boxes include ratings for...

### GRAPHICS

All aspects of the game's graphics with the limitations of each machine taken into account. A good-looking Spectrum game will therefore score higher than an average-looking Amiga one.

### AUDIO

The music and sound effects are rated here. A high rating is

possible on even limited machines like the Spectrum and PC if the computer's shortcomings are cleverly sidestepped.

### IQ FACTOR

Yes, sometimes you have to use your brain. This rating evaluates the risk of mental effort – which some people actually enjoy...Note that ACE readers are generally reckoned to be more intelligent than other human beings, so the ratings may be lower than you expect...

### FUN FACTOR

Basically a measure of mindless addictiveness. Games like *Arkanoid* and *Flying Shark* require virtually zero brain power but are still remarkably addictive. Most coin-ops score well here because they are designed for instant satisfaction. Games don't have to be either fun or intelligent – they can be both.

### ACE RATING

This is not just plucked out of the air but is calculated from the area under the PIC Curve. To get a really high rating a game will not only have to be very addictive but stand the test of time as well. Just because a game does not get over 900 does not mean we are not recommending it – the following is a general guide to what the ratings mean.

**900+** A classic game, recommended without reservation.

**800-899** A superb game, but perhaps lacking the long-term depth to last into the month and year categories.

**700-799** Still highly recommended, but probably has a couple of aspects to the gameplay that take the edge off it.

**600-699** The 'fair' zone, where it tends to be very good 'if you like that sort of thing'.

**500-599** This still has good things going for it, but the game clearly has some noticeable problems.

**400-499** Problems with gameplay and programming make this an inferior game.

**300-399** Not only is the gameplay bad but the design was probably flawed in the first place.

**200-299** Things are getting really serious now...  
**100-199** ZX81 games running on an Amiga.

**Under 100** Nothing has ever achieved this appalling level of rating. If anything ever does, it wouldn't even be worth having it for free.

### VERSION BOXES

This covers version-specific information on graphics, audio, loading problems etc. If there's no box for your machine but a version is planned, it'll be covered as an update in a later issue.

### THE TEAM

...includes **Steve Cooke**, one of the original editors of this award-winning magazine, known to thousands through his many other previous identities, including Zzap!'s White Wizard, The Pilgrim, and Old Baldy. **Eugene Lacey** is the man who put Britain's top-selling games magazine, C&VG, on the map. Luckily for us, Eugene got fed up with writing for 8-year olds and decided the time had come to tackle the challenge of ACE magazine. As one of Britain's most experienced games journalists, his word is LAW. **Laurence Scottford** is ACE's new staff writer – Laurence has been playing games since he was nipper, but some of them we probably ought not to mention. There was hot competition for the ACE Staff Writer position from gamesters all over the country, but Laurence pipped them all at the post by show-

ing that he could not only push a game to its limit, but he could push a pen too and tell you all about it. Other reviewers include **Kati Mamza** and **Gordon Houghton**, both of whom used to provide the reviewing talent for 'another magazine' but decided that ACE was worthier of their talents. Finally, **Mike Pattenden** is editor of *Commodore User*, one Britain's most prestigious Commodore magazines. What Mike doesn't know about software could be written on a 6502...

**We don't review anything until we are 100% certain that we've got it right. We've checked them out thoroughly – now you can too.**



**TENGEN'S** *Hard Drivin'* managed to go up a gear on its numerous racing rivals in the arcades earlier this year with its realistic handling controls.

Tengen have concentrated their efforts on making the car handle like a true racing simulation – rather than lavishing stacks of code on pretty scenery and background graphics.

The visual effect of this approach is to create a game that looks very simple – basic geometric line drawings and blocky angular shaped vehicles on the road. But what *Hard Drivin'* may be considered to lack in graphics it more than makes up for in game play.

You are placed at the controls of a super fast sports car competing in a race against several other cars on a choice of two tracks.

The Stunt track features three exciting challenges; the Bridge Jump, Loop-the-Loop, and the Bank. It is also the part of the game where the main thrills and spills are to be had.

Getting the speed and approach right as you go into these stunts is the key to success – and mastering this control will take a good deal of practice.



# HARD DRIVIN'

DOMARK put the hammer down

Steering the car in *Hard Drivin'* also appears quite difficult on the first few attempts – but this is very much by comparison with other racing games that actually operate quite unrealistically under joystick control. *Hard Drivin'* is much more realistic. If you swing wildly out of control in one direction then in your attempt to right your position you are likely to swing pretty strongly in the opposite direction. Skidding also needs to be mastered if you are to become a skilled *Hard Drivin'* ace. The skidding is excellent fun and can be used to particular advantage on the Bank.

The computer helps you master the steering and acceleration with a variety of on-screen prompts. Steer wildly out of control and you may find yourself driving down the road in the wrong direction – but the computer points this out to you. Because of the delicacy of the steering a directional arrow moves slightly to the left and right. Keep this centred and you will not go too far wrong.

Another feature there to help you is the action replay sequence. This gives an out of car view of the action (As opposed to your view of the road from the drivers seat, i.e. you are viewing the whole car). Particularly exciting viewing it makes too, especially if you come off the Loop the Loop track at high speed. But it is there for more than mere entertainment – it enables you to try things out and see how the car performs.

A choice of automatic and manual controlled gears are available. The automatic gears enable you to concentrate on the stunts and the race – but once you have become famil-

Spectrum version ▶

RELEASE BOX		
ATARI ST	£19.99dk	OUT NOW
AMIGA	£19.99dk	IMMINENT
SPECTRUM	£9.99cs • £14.99dk	OUT NOW
AMSTRAD	£9.99cs • £14.99dk	IMMINENT
C64/128	£9.99cs • £12.99dk	IMMINENT
IBM PC	£24.99dk	IMMINENT
ARCHIMEDES	Approx. £30.00dk	JAN 1990



iarised with the controls you may decide that real men use gears.

As you squeeze the accelerator the white lines in the middle of the road soon start to disappear quickly underneath your car as it roars forward. The feeling of speed is very convincing due to the very low perspective you have of the road.

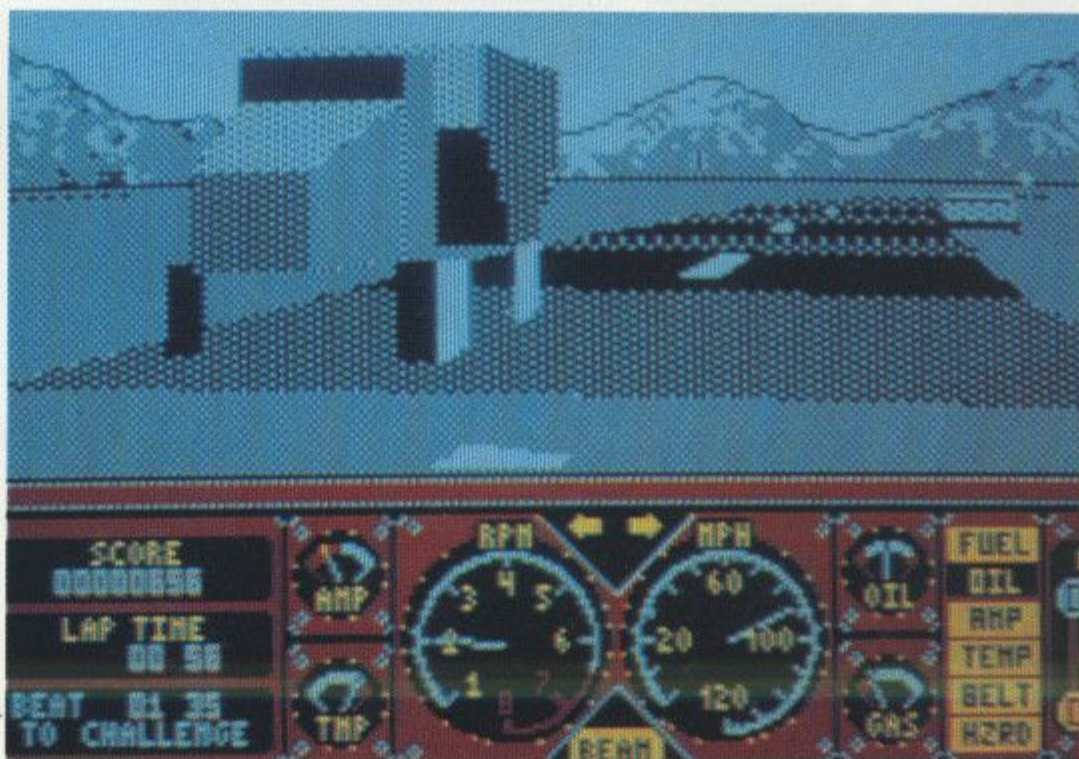





**ST VERSION**

Near perfect conversion of the Tengen original. The speed is there, the music, and skidding, complete with sound effects to match. One of the very best racers now available for the ST.

**GRAPHICS 9 IQ FACTOR 9**  
**AUDIO 8 FUN FACTOR 9**  
**ACE RATING 937**

**ST Version:**  
**Action replay view of the Loop the Loop stunt. The driver lacked sufficient speed to pull it off.**



**ST version:**  
**Driver's eye view of Loop the Loop. Foot down, deep breath, and close your eyes.**

**SPECTRUM VERSION**

The main race window features a monochrome display. Despite this the graphics are very detailed and the track moves fast enough to be convincing. It is slightly jerky but this is only to be expected. Greatly to the programmers credit, every single important game play element has been included - right down to the action replay. Once again a Spectrum conversion of an advanced coin-op is pulled off against the odds. First class Spectrum racing.

**GRAPHICS 8 IQ FACTOR 9**  
**AUDIO 7 FUN FACTOR 9**  
**ACE RATING 921**

The tracks are dotted with checkpoints which measure your progress against the game clock. If your speed is good enough you may get a crack at the Phantom Photon (computer controlled car) in a race around the Stunt Track.

The Phantom makes a tough adversary and accelerates away from the start at great speed. Taking him on is for the advanced Hard Driver - but is a challenge well worth building up to.

The appeal of *Hard Drivin'* is in the pure joy of racing along - over taking other cars, and the sensation of speed that is created in the process. The stunts are the icing on the cake, but in the end it's the racing that remains as the main attraction.

*Hard Drivin'* appears to have an addictive hook that many of the current crop of racing coin-ops lack. Domark have captured the addictive spirit of the game for home consumption. Unputdownable and certain to be the Dom Dom's biggest hit to date - possibly even pipping all the other Christmas racers to the number one slot.

● Eugene Lacey

**PREDICTED INTEREST CURVE**

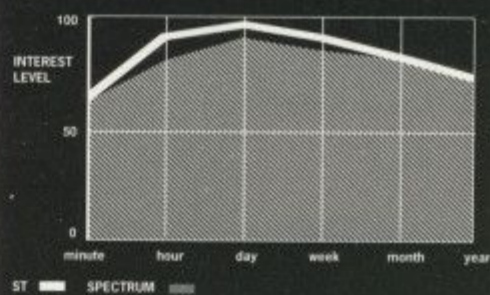

Potentially timeless entertainment as *Hard Drivin'* is likely to become the favourite racer for many gamers - and thereby get many regular spins.



# ENTERTAINING YOUR P.C.



## VETTE™ Spectrum Holobyte

Outstanding 3-D solid modelling graphics. Accurate mapping of San Francisco streets and landmarks. Real manoeuvrability. Test performance factors of each Corvette. Varying difficulty levels. Option to choose from 4 Corvettes. So get set, buckle up and rev up. But a word of caution – don't be too reckless or you might leave more than your heart in San Francisco!

£34.99

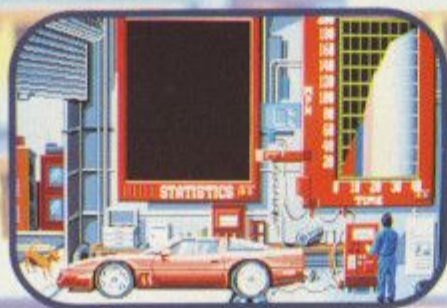

## DUNGEON MASTER™ FTL

Step into the world of DUNGEON MASTER and see fantasy come to life. Set in the depths of the mysterious underground, DUNGEON MASTER puts you inside the most detailed dungeon ever created in software. Everything moves and works! Pick up objects with the mouse and take them with you or pick up the key and try to unlock the locked door. Maybe there's treasure on the other side or maybe there's a hungry monster.

£39.99

## OMNICRON CONSPIRACY™ Image Works/First Star Software

As a Star Police Captain, it's your job to keep the peace in the Universe – OMNICRON is bogglingly complex. Search everything, search everywhere. And don't take no for an answer!

£34.99



## WOLFPACK™ Mirrorsoft/Novalogic

Take charge of either Allied destroyers or German U-Boats in this classic simulation of war at sea. With seven period scenarios, as well as a full construction set, WOLFPACK lets you examine any aspect of North Atlantic naval warfare throughout the 1939-45 conflict. WOLFPACK is the most sophisticated submarine surface simulation EVER!

£24.99



All screen shots shown from PC versions. All titles © Mirrorsoft Limited 1989

Omicron Conspiracy published under license from First Star Software Inc. Wolfpack published under license from Novalogic

Mirrorsoft Ltd Irwin House 118 Southwark Street London SE1 0SW Tel: 01-928 1454 Fax: 01-583 3494



# BRUCE LEE LIVES!

SOFTWARE TOOLWORKS bring the muscle-bound hero of Chinese kung-fu revenge movies back from the dead – and give him artificial intelligence to boot.

**SOFTWARE** Toolworks certainly can't be accused of putting out programs that look similar, however. Last time out came *Life and Death* – the game when you were trying to cure people. Now *Bruce Lee Lives*, where you are trying to kick their heads in. Naturally Bruce is the good guy, trying to defeat the assorted forces of Master Po. But I'll tell you this – it's not easy.

The martial arts bit itself is quite straight forward, with about 15 sensibly positioned moves – activated either by joystick or keyboard, with or without fire/shift pressed. One particularly nice bit is the fact you can program a series of three selected moves into a "macro" – activated by a single keystroke during the combat sequences. This can be quite useful.

First it's into the training room to practice your skill on the punch bag. You'll find this vital if you are to get through the initial testing stages. No 'straight into the action' stuff here – you first have to prove your worth in the qualifying rounds. This is not a simple workout – from the very beginning the program starts to show its well concealed teeth. Because it learns.

Remember back in the old days, when you used to be able to find a series of moves that always, always, always used to take the opposition out? *Bruce Lee Lives* just won't stand for that sort of crap. The blurb claims that it identifies moves and sequences that you commonly use – then adapts its tactics accordingly – up

to the point of using your particularly good sequences back on you!

First off, I tried using the repeated jump kick – and was pretty successful. 'Ah so' methinks – this learning business is a pile of doggy. Next qualifying round, tried again. Got beaten to a pulp. Tried again – serious intensive care needed. Surely some coincidence.

A trip back to the gym quickly installed a new jump kick, low kick, jump kick sequence – then back to the qualifying. This worked a lot better immediately....until the second round. Pass the plasma please, Vicar. Take it from me, the program is smart!

Having got through the qualifying rounds, you go on to a number of missions of increasing difficulty, ending with a final confrontation with Master Po himself. You can only take on a harder mission, 'though, when you have com-

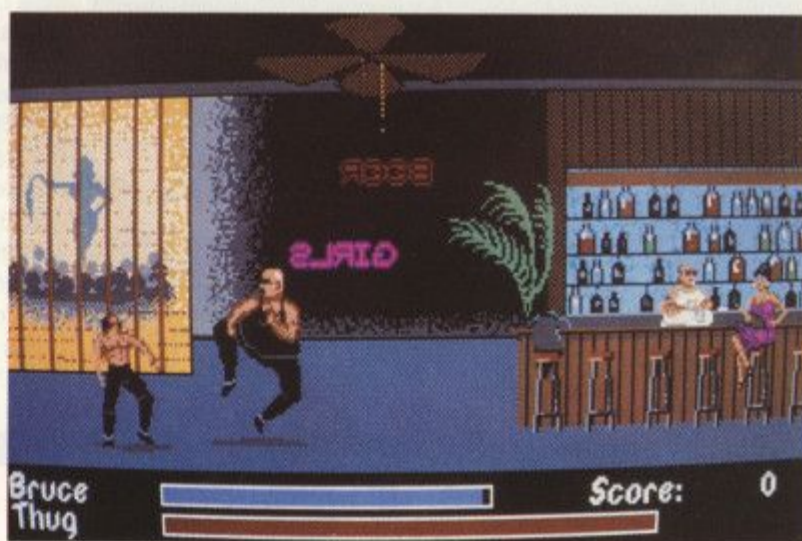

You're not just looking at one move here: the program lets you define macros for multiple attack tactics.

pleted the ones before it.

One point, your energy does replenish at a slow but constant rate while fighting – but there again, so does that of your opponent. Here I found the single glitch I could complain of – you can get into a repetitive sequence of punching each other, when very close together. Neither of you inflict damage, but your opponent will not back off if you carry on punching, he'll just punch back.

You can use this to take a breather if you are hopelessly behind in a bout and recover all your lost stamina. OK, so will your opponent, but he never goes beyond 100%, so you soon catch up.

This learning thing has to be the main challenge to the game, in all honesty. The graphics are fine, but not stunning – unlike a EA's *Bodokan* to be reviewed next month – and although there is a story line to it, there is no variation in the weapon types or disciplines used.

But despite that, however, it is highly playable and will present you more of a challenge than the run of the mill beat-'em-up plus it will certainly retain your interest for longer. On that premise alone, it's well worth a look.

● John Cook

## PREDICTED INTEREST CURVE

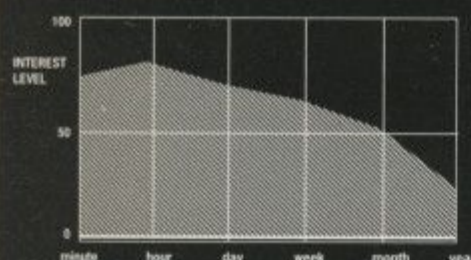

Rapid appreciation of the program's learning instinct leads to long term challenge.

## RELEASE BOX

ATARI ST	£TBA	Early 1990
PC	£24.99dk	OUT NOW
AMIGA	£TBA	Early 1990

## PC VERSION

Fast, colourful, and above all intelligent. Don't expect too much in the way of sound – but you're used to that, aren't you?

GRAPHICS	7	IQ FACTOR	6
AUDIO	4	FUN FACTOR	7

ACE RATING 768



# WONDER BOY III

Hack'n'slay with cutie power on the SEGA.

**WONDER** Boy is back in his third incarnation, once again bringing the art of the silly sprite to the Sega. As with the other Wonder Boy titles you play the adolescent hero as he carves his way through various baddies (none of whom look in the least bit threatening), in a platform based action adventure.



Wonder Boy confronts the evil fire-breathing dragon. Even if he manages to defeat the monster all will not be well. The dragon has something nasty up its scaly sleeve.

This time you begin your adventure as per any day of the week. You know, it's the usual monster hacking routine (no sweat). But things start to go wrong when you come across the nasty old Dragon. When (and if) you manage to mortally wound him he throws a horrible curse and turns you into Lizard Man (yuk!). Which only goes to prove what you suspected all along — Dragons are really bad losers.

Well, no use crying over spilt milk — you're a lizard now and you're going to have to work out how to regain your normal form. It isn't all bad news, however, you do look very cute as a Lizard (honestly, it suits you). Even so, you'll probably not want to stay that way for too long.

The answer lies in a magical item known as the Salamander Cross (no, not an award for heroic lizardry but the only thing that can restore you to normality (normality?!). The rest of the game concerns your quest for the said

Cross, and involves the usual bizz with a whole host of colourful nasty critters.

The game is quite enjoyable to play and has some nice touches. The sprites are fun and well animated (look out especially for the way Wonder Boy himself skids to a halt when you stop. The scenery features are very good too, like the giant springs which launch Wonder Boy/Lizard Man onto higher platforms. Good arcade adventure fare for the committed...

● Laurence Scotford

RELEASE BOX		
SEGA	£27.95 cart	OUT NOW
GRAPHICS	7	IQ FACTOR 4
AUDIO	6	FUN FACTOR 7
ACE RATING 675		

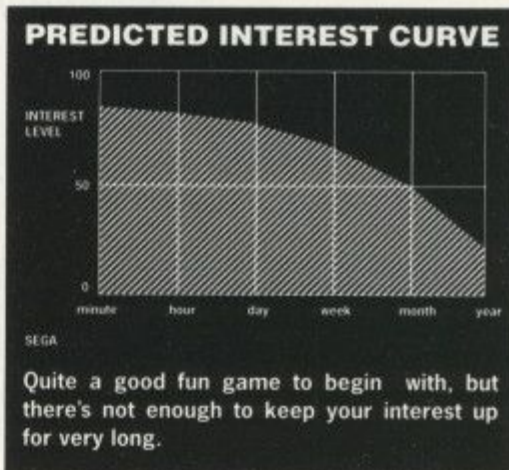

# GHOSTBUSTERS

The classic spook license now haunts SEGA...

**IT'S** always a rather pleasant surprise when a film tie-in turns out to be a good game. Such was the case with the original Ghostbusters game, released way back in 1984. Activision, the company responsible for the title, chose to concentrate on the more obvious action sequences from the film rather than worrying too much about a subtle plot. This approach seems to have worked well.

The game on the Sega plays much the same as it did on the original computer versions. You begin with a small amount of cash with which you can buy a basic ghostbusting

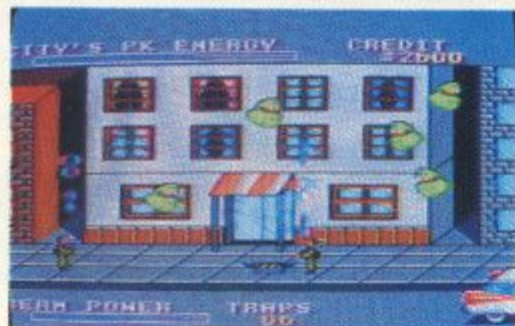

Our heroes move in, ion beams and ghost-trap at the ready, in an attempt to bag a few more ghosts. They had better get it right, though, or they'll be slimed.

vehicle and equip it with the essential pieces of equipment needed to go out and bag ghosts. Once you have kitted up, it's time to drive off and nab some nasties.

In the first section of the game proper you are presented with a map of the city. The Gatekeeper and The Master of the Key are both wandering around. If they happen to meet and make their way to Zuul, then things start getting nasty. Meanwhile, you guide your ghostbusters symbol around the streets touching the ghosts before they accumulate and form Marshmallow man.

In the second section of the game in which you have an overhead view of your ghostbusting vehicle driving through the streets. You must avoid other traffic, while sucking up the passing ghosts with your ghost vacuum. Once you arrive at the infested building you enter the section of the game which actually requires some sort of skill. Here you must manoeuvre your ghostbusters with their ghost trap and ion beams to capture all of the ghosts floating in front of the building. If you fail to trap them all you will be slimed. Ugh. Your ultimate aim is to build up enough points to enter Zuul before the city's PK energy gets too high. Then you can

sneak past the Marshmallow man for your final confrontation with Gorza.

The appeal of Ghostbusters really lies in the sheer variety of the gameplay, even though some of the sections are ridiculously simple. As an added attraction, the better you do, the more complex and useful the equipment you can buy. This feature is likely to keep you coming back to the game, even after you have played it several times.

● Laurence Scotford

RELEASE BOX		
SEGA	£27.95 cart	OUT NOW
GRAPHICS	7	IQ FACTOR 5
AUDIO	5	FUN FACTOR 8
ACE RATING 725		

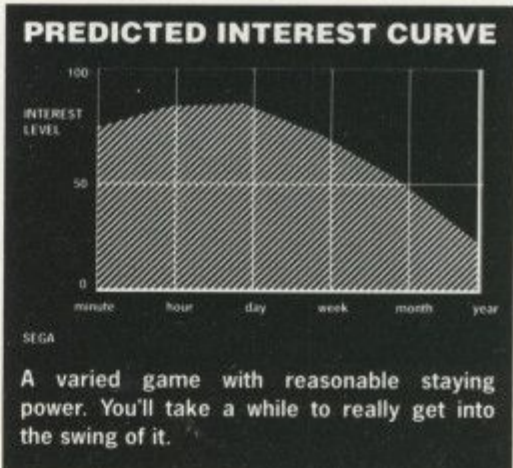



# SWITCHBLADE

GREMLIN's little Cyber Knight goes forth into arcade adventure land

**THE** cyber world of Thraxx is about to enter a new era of darkness and despair. The dark lord of nightmares, Havok, having slept for 10,000 years has finally woken. The Fireblade has been broken, and it's sixteen pieces scattered through the underworld where Havok now reigns. The slaughter has begun, and all of the Bladeknights, hi-tech warriors of Thraxx are dead. All, that is, except one. The last of the Cyberknight's, Hiro, is Thraxx's last hope.

Harrowing stuff isn't it? You, naturally enough, play the hero Hiro (sorry about that), in this platform based arcade adventure with beat-em-up elements. Your task is to search the undercity for the sixteen pieces of the Fireblade. Once you have collected them all you will be ready for your final confrontation with Havok.

During your search you will have to tackle the many evil creations of Havok. To begin with you have a basic series of punches and kicks to defend yourself with. Fortunately for you, your Cyber Arm is reprogrammable. Yes folks, that means Power Ups, and lots of 'em. Rather than have a whole gamut of complicated joystick moves for each offensive movement you must use a power bar (a la R-Type) to gauge the strength and type of each punch/kick you make. This depends on the length of time that you hold down the fire button.

Make short stabs at the button and you will throw light punches. These are quick, but not very powerful, so you will have to keep pum-

meling away at your opponents for quite some time before they disappear in a puff of pixels. Hold the button down for long enough however and you will execute a perfect sweeping kick - powerful enough to dispatch most bad guys with one blow.

The actual display shows only the areas you have already explored. Any areas you have not yet entered are initially dark. This makes the whole task of exploring the complex a lot more interesting. Often areas are accessible only after you have smashed your way through a crumbling wall, so it pays to be thorough. This is especially the case with regards to power-ups and bonuses, which are frequently hidden behind crates.



If he's quick enough, Hiro can grab the crystal above him for a bonus.

Graphically, *Switchblade* is quite nice. The sprites are not that large, but this does allow for a larger playing area. There are also some fairly tuneful ditties playing alongside the usual spot effects. Gameplay seems to be pitched just about right as well. The combat method works well, and allows you to get straight into the game without having to absorb half-a-dozen impossible controls. Well worth a look - there should be something here to satisfy most people.

● Laurence Scottford

RELEASE BOX		
ATARI ST	£19.99dk	IMMINENT
AMIGA	£19.99dk	OUT NOW

MINI PIC					
min	hour	day	week	month	year
ST & AMIGA					
Time needed to adjust, then it's all go					

<b>AMIGA VERSION</b>	
Small, but cute sprites and a dinky soundtrack make for a fairly enjoyable romp. It's not a game that I would classify as an 'Amiga game', however, in that it doesn't really do anything that you couldn't do just as well on an ST. Don't let that stop you from giving it a try however. It plays well once you've got into the swing of things.	
<b>GRAPHICS</b>	<b>8 IQ FACTOR</b>
<b>AUDIO</b>	<b>7 FUN FACTOR</b>
<b>ACE RATING 805</b>	

# BEWARE



## THE HOUND OF SHADOW

The Hound of Shadow is set in London in the 1920's and is rich in the atmosphere of the era. It features 'Timeline' a new role-playing system.

Use investigative research to discover the secrets of arcane lore.

Available for ST and Amiga. Coming soon for PC.

To order direct, send £24.99 to ELECTRONIC ARTS, Dept HOS, 11-49 Station Road, Langley, Berkshire SL3 8YN. For more information call 0753 40906.



Visit London in the 1920's

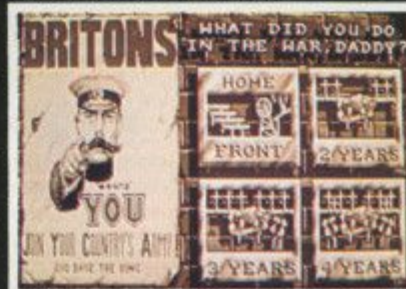

Create your character

*"It's an exciting game that should give you plenty of sleepless nights: when you're not up playing it, it will be on your mind..."* ST Format-Gold

*"The game's storyline is well-researched and absolutely oozes atmosphere."* ST Action

ELECTRONIC ARTS



# ONSLAUGHT

Colourful battle-lust from the berserkers at HEWSON

**WHEN** you've had one of those really hard days at work, everything that can go wrong has gone wrong, and you're just about ready to explode, there's nothing better than taking on a whole army single handedly and having a good hack for half an hour or so. Let me tell you, it's a really good way to shift that old tension headache. Just in case you haven't got a few friends handy who are willing to be hacked about a bit, Hewson have come up with the perfect solution – *Onslaught*.

If, like me, you have always thought that conventional wargames were a bit dry (my apologies to all those hard core table top war enthusiasts out there), then *Onslaught* is the game for you. It is based around the mythical land of Gargore. A land peopled by war-like tribes, each of whom worships one of the many gods (all neatly explained in the rather detailed manual). You play a lone warrior, also a follower of one of these gods, who sets out to conquer the entire land (ambitious eh?).

There are several phases to the game. The first presents you with a square battle map, divided into a grid with each cell representing either a kingdom, a temple, or a landscape unit. Landscape units are shown as mountains, water, and so on. You cannot cross these unless you have collected the relevant magical charm, available at certain later stages of the game. By moving the cursor over an adjacent enemy kingdom you are shown an information panel giving you the alignment, type, strength, and so on of the people who reside there. If



The battle map, showing the territories that make up the war-scarred land of Gargore

you now press the fire button you can attempt to conquer them.

Conquering kingdoms is the main, meaty part of the game, and is achieved in three stages: field battles, sieges, and mind battles. The first two are quite similar and are the best parts of the whole. When you first see the graphics for these stages you are going to be absolutely gobsmacked. You are presented with a sideways scrolling view of your warrior battling, claw and tooth, with the opposing army. The sprites are absolutely first class. Incredibly detailed, and extremely well-animated.

These are set against equally brilliant background graphics and a colourful, graduated sky, which obviously involves some pretty intensive palette switching.

You begin at the far left of the battle field and must slash and hack your way through the enemy forces to reach the opposite side of the field. It's not just a case of ploughing your way through however, for if you let too many of the enemy get past you then you will lose the battle. To start with you are armed only with a mace, but as you kill your opponents they leave shields behind which can be collected to gain more powerful weaponry. Selecting weapons can prove a little tricky in the heat of battle. Fortunately, there is a tutor mode that automatically collects and selects weapons for you. The only disadvantage with this mode of play is that your score is never entered on the hi-score table.

The second stage, siege, is much like the first only you actually enter the enemy's fortifications. The third stage, mind battle, is a sub game in a completely different style. It supposedly represents the psychological battle between you and the enemy leader. This involves moving a cursor around a weird looking head with flailing arms, and firing at it, while avoiding return missiles, and collecting bonuses. The same section is also used if you attack a temple. Should you win this last stage, then you have successfully conquered that kingdom.

As you slowly conquer kingdoms on the battle map you will also have to contend with plague and rebellions, making it just as difficult to keep kingdoms under you as it is to gain them in the first place.

*Onslaught* is a superbly presented game, with a lot to it. It is quite enjoyable to play, but the method of selecting weapons and the over busy on-screen action can make it difficult to keep pace with the game. This is a shame, as it flaws an otherwise excellent product. I also suspect that conquering kingdoms could become a bit monotonous after a while. Having said that, if you enjoy a bit of frantic Hack 'n' Slay, then this is definitely the game for you.



Our hero is about to be impaled by a passing charger. While he's dying there's time to admire the colourful sky. Which, incidentally, can be edited by the player

## PREDICTED INTEREST CURVE

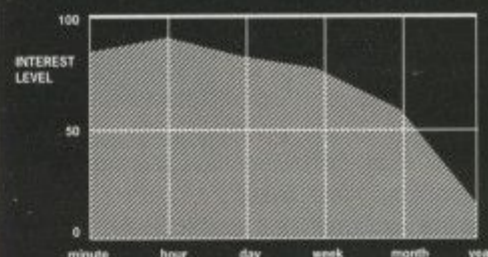

Initial high expectations are not disappointed. I'm not convinced it has staying power though.

## RELEASE BOX

ATARI ST	£24.99dk	OUT NOW
AMIGA	£24.99dk	IMMINENT

## ST VERSION

Your immediate reaction will be: 'That's never running on an ST!'. The graphics are incredible. Forget any notion of dull 16 colour limitations on this game. The scrolling is as good as you can expect from the ST, bearing in mind that, on this machine, it's a fairly processor intensive activity. Hewson haven't let you down in the sound department either. They've obviously worked hard on getting the old prehistoric sound chip pushed to its limit. Loud, Colourful, Fast and Furious... What more can I say?

GRAPHICS	9	IQ FACTOR	5
AUDIO	9	FUN FACTOR	8

ACE RATING 850

● Laurence Scotford



ATARI...THE POWER BEHIND

# ARC

REACH OUT FOR THE POWER

## ARCADE POWER

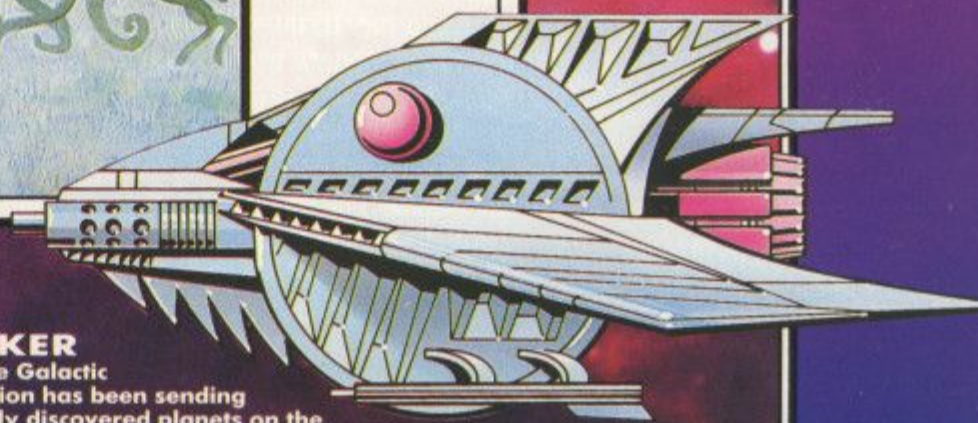
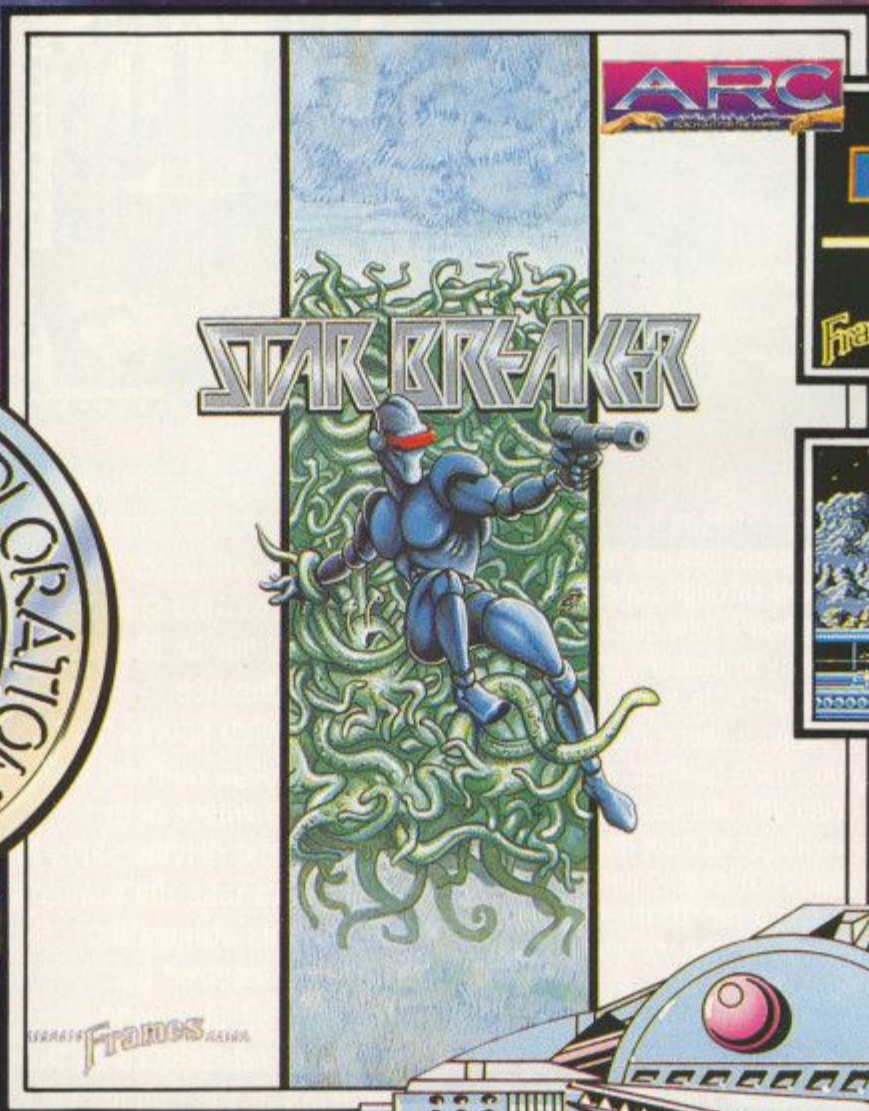

Screen shots from various systems.

### STAR BREAKER

The year is 3189. The Galactic Exploitation Federation has been sending mining corps to newly discovered planets on the periphery for thirteen years. New Chicago is one of the New City Systems of planets lifeless, except for the mining colonies, but rich in mineral and precious ore deposits. Members of the Rrampon Farmer's Guild have overrun New Chicago in the miles of underground tunnelling created by the mining colonies. The directors of the Galactic Exploitation Federation have offered a substantial bounty to anyone clearing the planet of its unwanted visitors. You and your ship SS Star Breaker change course and head for New Chicago .....

ATARI ST · AMIGA · IBM PC £19.95

"...among the best arcade games on the market" STUser

REACH OUT FOR THE POWER OF ARC  
ATARI ST · CBM AMIGA · IBM P.C.

ARC, P.O. Box 555, Slough SL2 5BZ.



# 1000%

## BY NAMAMI

### AFTER BURNER



SHAKE ... RATTLE ... ROLL IT

**AFTERBURNER** — You've played the arcade smash — now experience the white-knuckled realism of a supersonic dogfight at home! Using your heat-seeking missiles and laser anti-aircraft fire, can you be top gun against supersonic swarm?

Experience brain-numbing G-forces; bones rattling with the body-jarring pitch and yaw... scan with your radar, lock on your target and FIRE!

AFTERBURNER™ SEGA © are trademarks of SEGA ENTERPRISES LTD. This game has been manufactured under licence from Sega Enterprises Ltd., Japan.

### LAST NINJA 2

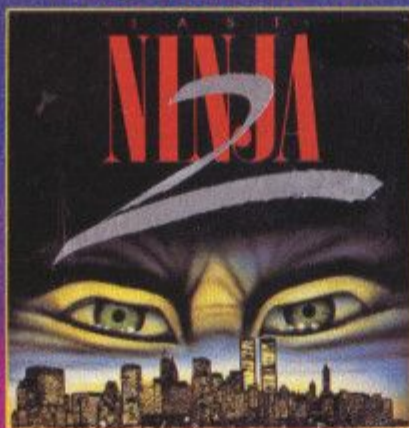

Once beaten, but not destroyed, the evil Shogun Kunitoki used all his mystic powers to transport himself through time and establish a new empire of tyranny in modern day Manhattan. In fear of Kunitoki's growing powers, the arcane gods used all their wisdom to bring you, the Last Ninja, across the abyss of time and confront your arch-enemy once more. You arrive in this frightening and awesome modern world bringing nothing with you save your intelligence, skill and cunning and a burning desire for vengeance. Will this be the final battle? Can you vanquish Kunitoki once and for all?

© System Three Software Ltd. All rights reserved.

### WEC LE MANS

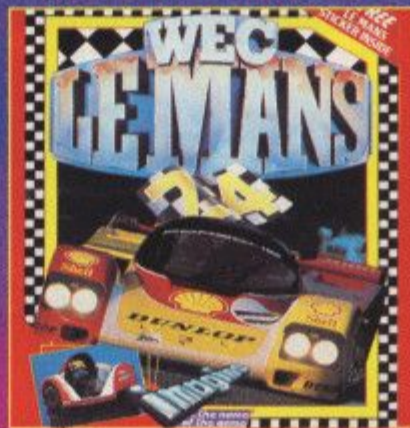

The World's most famous sports car race comes to your home computer screen with this exciting simulation of the 24 hour Le Mans race. World endurance Championship sports cars battle through day and night sequences where both strategy and driving skills are required to take the winner's laurels. This stimulating challenge inspired by Konami's sit in driving simulator reproduces all the elements at the famous race with every twist and turn of the track.

© Konami

### DOUBLE DRAGON

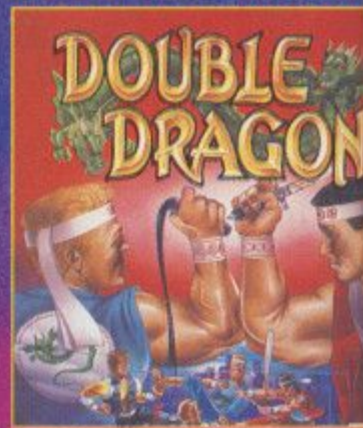

Skillful programming has taken the superb graphics and addictive game play of the monster Arcade hit and faithfully reproduced it in home computer versions.

Join in deadly combat with the savage street gang of the infamous Shadow Boss. Use whatever weapons come to hand as you pursue the gang through the slums, factories and wooded outskirts of the city to reach the Black Warrior hideout, for the final confrontation with the Shadow Boss himself!

©1988 Mastertronic International, Inc.

# FOUR EXPLOSIVE HITS IN ONE SPECIAL COMPILATION

SPECTRUM  
COMMODORE  
AMSTRAD

## £14.99

CASSETTE

FROM

# ocean

ALSO AVAILABLE  
ON DISK

## £17.99

Ocean Software Limited · 6 Central Street  
Manchester · M2 5NS · Telephone: 061 834  
Telex: 669977 OCEANS G · Fax: 061 8340



# FUTURE WARS

PALACE SOFTWARE import a great Gallic graphic adventure.

**ADVENTURES** have seen something of a revival recently – but not, perhaps, in the way that many old adventure die-hards might have hoped for. The text adventure seems to have finally died a death (at least in the sense that none of the larger commercial software houses cater for this format any more). When a company like Level 9 (having already made a concession to graphics fans), packs its bags and moves on from a genre it has been renowned for, then you know that change is in the air.

There has been a noticeable move towards more complex graphics, and simpler, though more sophisticated, ways of interacting with the machine than was afforded by some of the early adventure classics. This is, perhaps, not surprising, given the widespread availability of machines like the ST and Amiga which both boast a powerful processor, large amounts of memory and easily accessed graphical front ends.

Companies like Sierra-On-Line have lead the way forward with celebrated titles such as *Leisure Suit Larry*, *Police Quest*, and *Space Quest*. These are all distinguished by their heavy reliance on detailed background graphics, animated sequences, and the use of the mouse for movement and selection of many of the commonly used functions like saving and loading games. The Sierra games never completely divorced themselves from text input however, and although they all use an extremely advanced parser, which does make things easier, you still have to make the machine understand what you want to do through typed phrases.

At first sight, this new graphic adventure from French developers Delphine Software looks quite a bit like the Sierra adventures. But the resemblance is only superficial. An immediately noticeable difference is the superior quality of both the graphics and sound effects. They are not just good, they're first class. Much the same goes for the animated sequences which occur at particular points throughout the game. Attention to detail, especially in the presentation, is found throughout.

## PREDICTED INTEREST CURVE

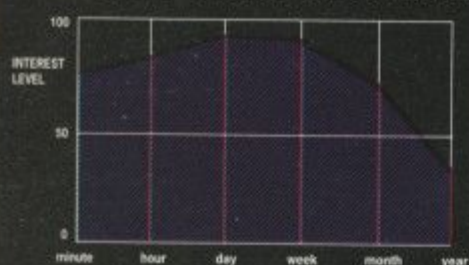

It will take a while to get into the game, but you won't be disappointed. Shouldn't take too long to solve though.

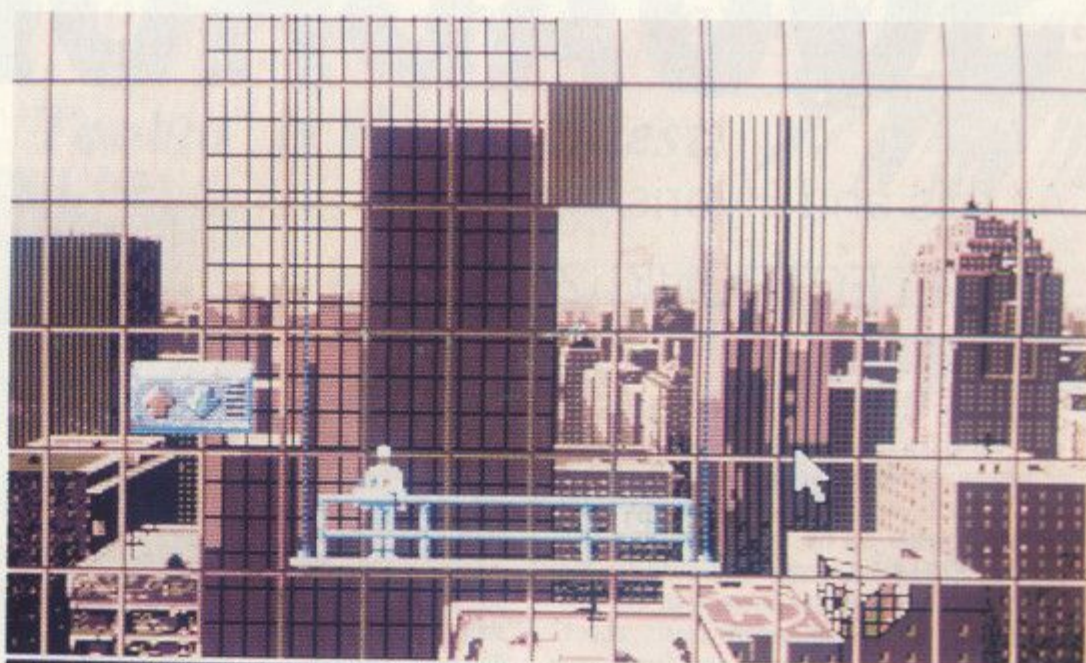

Impressive isn't it? This is just the opening location, and there's plenty more where that came from.

For example, rather than captions, text boxes, and menus blocking out huge areas of the screen, they are presented as white text on a translucent grey background, a la Channel 4. This way, you can still see the graphics beneath them.

Movement is achieved by moving the pointer to your planned destination and clicking the mouse button. The hero, an office window cleaner, then attempts to walk towards the spot you have indicated. When you come to give him other instructions you discover the beauty and economy of the Cinematique system that has been used to create the game – no text entry!

By clicking the left mouse button you call up a menu of standard adventure commands: EXAMINE, TAKE, INVENTORY, USE, OPERATE, and SPEAK. Once you have selected the option

you require, you move the pointer to the person or object you wish to apply the command to. For instance – if, in a standard text adventure, you would type 'OPEN BLUE DOOR', with Cinematique you would select OPERATE, then move the pointer over the blue door and click.

There are several advantages to this system. Firstly, there is no fiddling about trying to find just the right word to use, secondly, unless you're a touch typist, this method is much quicker. Another benefit that is probably not immediately apparent is that there are a limited number of combinations of commands and objects/people, so even if you cannot solve a problem logically, you can probably do it eventually through trial and error. (I can see purists turning the page in disgust!) This does mean that this adventure is likely to prove a lot less frustrating than most, especially for novice adventurers.

The actual plot concerns the thwarting of alien plans to disrupt history making their conquest of Earth in the 43rd Century inevitable. You have been unwittingly drawn into this rather messy state of affairs. You find yourself being dragged through several time zones in an attempt to put a stop to the diabolical machinations of the aliens. This provides plenty of opportunity for varied graphical locations and problems, that should be enough to keep most people happy for some time.

Although I can see that *Future Wars* might not appeal to adventure purists, it does succeed in making the genre accessible to a lot more people. It is certainly an enjoyable, well-presented product with a lot of depth, and I wholeheartedly recommend it if you fancy an adventure that is a little different.

● Laurence Scottford

## RELEASE BOX

ATARI ST	£24.99dk	OUT NOW
AMIGA	£24.99dk	OUT NOW
IBM PC	£TBA	EARLY1990

## AMIGA VERSION

In *Future Wars* there is none of the shoddy artwork you may have to come to expect from adventures in the past. Instead you are treated to superb graphics, stunning sound, and detailed animation. The cinematique system makes good use of the Amiga's mouse and graphical capabilities. A stunning product.

**GRAPHICS 9 IQ FACTOR 8**  
**AUDIO 9 FUN FACTOR 8**  
**ACE RATING 910**



# BATTLE SQUADRON

All this and Hybris Two from ELECTRONIC ZOO.

**IF** there's one word that sends Amiga-owning shoot 'em up freaks into an apoplectic seizure, it's *Hybris*. Released near the beginning of last year, Discovery Software's US imported blaster did for the Amiga shoot 'em up what *F/A-18 Interceptor* had done for the Amiga flight sim – mainly because at the time there were no decent quality blasts about, apart perhaps from *Sidewinder* and *Xenon*.

Such was the critical success of *Hybris*, a follow-up was inevitable – and here it is. It's not an official sequel – there's no *Hybris II* subtitle or anything like that. But it's by Martin Pedersen and Torben Larsen, the team behind the original, and after one look at the game there's no denying the similarities. In practical terms, *Battle Squadron* is really *Hybris 1990* – a 12" remix of the original, with Martin and Torben taking the original formula and giving the graphics, sound and gameplay an elaborate overhaul.

The most notable new inclusion is the simultaneous two-player option that seems sadly lacking in many shoot 'em up these days. Fight the good fight together with your mate to make the task that much easier – and enjoyable. There's a level of healthy competition produced as a result – you're a team when it comes to killing the alien peril, but as soon as a weapon capsule is released, it's every man for himself.

And talking of extra weapons... There are 25 in total. Remember in *Hybris*, how the weapon was upgraded through a series of stages? Well that's how it works here, but there are four separate and upgradable 'base'

weapons, each represented by a different colour capsule. There's not too much difference in style or performance, and it all comes down to personal taste which is the best weapon, but check out the Magma Waves for some wholesale destruction! And of course there's a complement of smart bombs for when the going gets tough.

Each level is broken down into two halves – the first takes place above the planet surface, where the aliens thankfully aren't too nasty, while the remainder is fought out underground, in the planet's subterranean caverns. This is where things get sticky as the huge stationary aliens that were such a pain in *Hybris* make a comeback – but this time they're bigger and beefier. Look out for the gargantuan Venus Flytraps!

Of course the end-of-level baddies are back, but they're badder and more vicious than ever. This time around it's not just a matter of pumping them full of lead – most of them have to be taken apart piece by piece in the correct order.

As sequels go, *Battle Squadron* does the job – the programmers could have copped out and done a few measly extra levels, but the complete facelift that's been done here means you've got a whole new shoot 'em up that still manages to retain the winning feel of the original. It's tough – at least as tough as *Xenon II* – but a moderator screen provided that allows you to mess around with numbers of lives, alien speed, extra weapons and so on to give you a head start.

Aesthetically it's a winner – a real improvement over the original with bigger, badder nasties and – something which *Hybris* lacked – proper varied landscapes. Check out the mechanical level for some jaw-dropping effects!



Scorching action from the programmers of *Hybris*.

All in all, *Battle Squadron* must go into the top three Amiga shoot 'em ups, along with *Xenon II* and *Silkworm* – not to be missed.

● Gary Whitta

## RELEASE BOX

AMIGA £24.99dk OUT NOW

No other versions planned.

## AMIGA VERSION

An excellent soundtrack comprising a plethora of themes and jingles does the business, and graphically there's little to touch it. It's the little touches like the slight left-to-right scrolling that give this the edge. The only quibble is that there's not much feeling of depth to the backdrops – perhaps some parallax scrolling would have helped? Gameplay-wise however, it's *Top-Hole*, *Numero Uno*, *The Big Cheese*, *Jolly Good Show*...

GRAPHICS 9 IQ FACTOR 2

AUDIO 7 FUN FACTOR 8

ACE RATING 867

## PREDICTED INTEREST CURVE

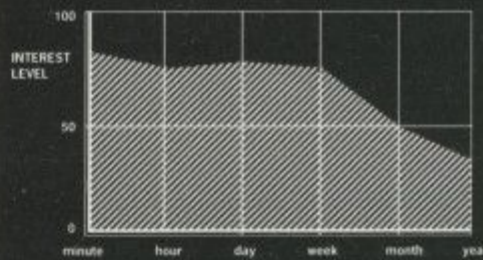

Blasting addiction all the way.

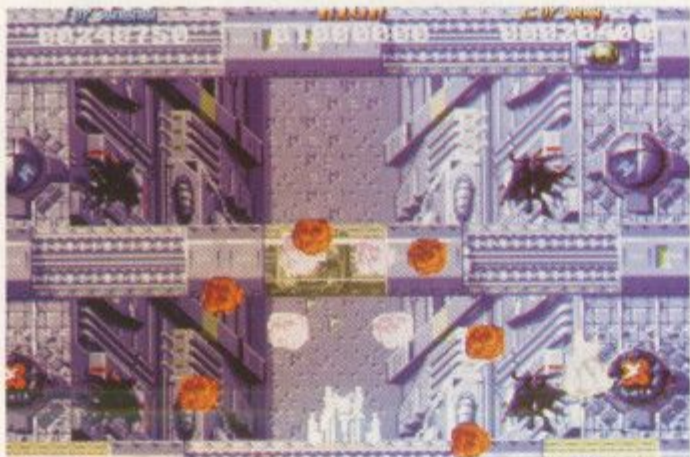



LET'S GO

# TOOBIN'

THE WORLD'S FIRST INNER-TUBE RACE!  
*The major coin-op arcade game of the year!*

*Toobin' is the wackiest,  
funniest and most  
entertaining  
game ever!*



ATARI ST SCREENSHOTS



© 1989, 1988 TENGEN INC. All rights reserved.  
TM Tengen Inc. TM Atari Games Corporation.  
Programmed by Teque Software Developments Ltd.

**TENGEN**

*The New Name in Coin-Op Conversions.*

**DOMARK**

Published by DOMARK LTD, FERRY HOUSE, 51-57 LACY ROAD,  
LONDON SW15. TEL: 01-780 2224

Available for: IBM PC, Atari ST, Amiga,  
Commodore 64 Cassette & Disc, Amstrad  
Cassette & Disc, Spectrum + 3, Spectrum 48/128.

...t go into the  
... along with  
... missed.  
● Gary Whitta

OUT NOW  
ed.

plethora of  
and graphi-  
little touches  
at give this  
there's not  
- perhaps  
- helped? Game-  
ero Uno, The

CTOR 2  
CTOR 8  
57

CURVE

month year



# THE THIRD COURIER

**B**erlin sounds like an exciting place these days. A quick visit with a hammer to chip a block off the Iron Curtain for posterity, a few free beers from emotional innkeepers, flowers from ecstatic passers-by, in fact just the place for a holiday if you fancy seeing history unfold before your eyes.

On a rather different level, Berlin is also the scene of Accolade's latest offering. It's a strange experience to wander up and down the Ku'damm in the game while simultaneously watching a TV program featuring hordes of tired and emotional Germans tumbling down the same street. With such strong competition from current events, can the game hold its own?

TTC takes place in the old Berlin and the Wall is most definitely in place. The program gives you the opportunity to create a number of Agent files, each of which effectively defines a player character who may then be 'activated' to enter the scenario. Your objective is to recover stolen NATO defence plans before they can be sold to the Russians by an apparently defecting Western agent.

Each time you play you can select any one of your filed agents and 'activate' him (or her). Relevant characteristics include the standard RPG-style attributes, but these have a rather subtle effect on the action during the game. What's most important is your ability (or otherwise) to handle a gun and your current potential for healthy living, both of which determine how long you're likely to survive constant attacks by panhandlers, muggers, drunks, and assassins.

You start the game in your apartment. The display shows your current location: there are three categories of location display rather as in *The Bard's Tale* series. Interiors of shops and apartments are revealed as single flip-screen rooms. Exteriors scroll towards you with a perspective view each time you move, and there are also the equivalent of 'dungeons' - sparsely detailed perspective interiors that scroll in a similar fashion.

**As the Iron Curtain is swept aside, ACCOLADE plunge you back into the Cold War. NATO plans are missing, and it's up to you to create an RPG-style character and get after them...**

Encounters involve the relevant assassin or colleague appearing as a detailed figure superimposed on the current location graphic. A description of the encounter is flashed up, and if things turn nasty you'll be keeping a close eye on your character attributes on the right of the screen. It doesn't take many shots from a policeman's NATO rifle to get the health down to zero.

Commands are all menu-driven but the design of the menus can mean some rather tiresome multiple selections for frequently needed options. For example, confronted by a policeman demanding your papers, you have to ACTION, USE, US PASSPORT every time. Adding in an ENCOUNTER menu could cut this and other hassle factors down considerably.

This may seem like a small problem, but it's compounded by the game's most serious design flaw: over-frequent and uninteresting encounters. While you explore the city, you're constantly challenged by police who only want to see your papers. In the end it becomes so tiresome that it becomes a real disincentive to further movement. Other

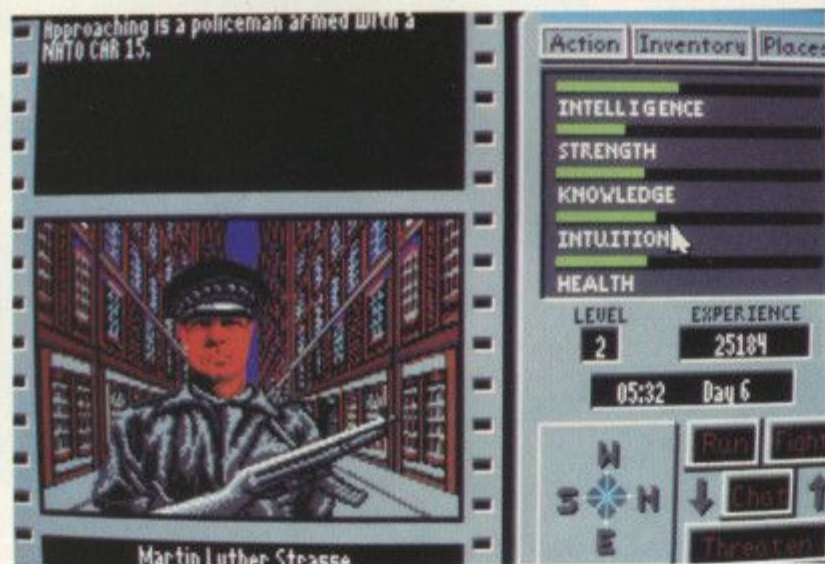

**A policeman confronts you in the street near your apartment. All encounters take this format: a graphic figure, and limited interaction. If you kill someone, you can usually take their weapon.**



**An interior Dungeon-style - this is a hotel.**

encounters are just as dull and after being told to get lost by the nth identical looking barman in the nth identical looking bar, you're looking up at the shelf for something else to play.

Your search for the NATO plans involves similar repetitive gameplay as you question everyone you meet (almost always with identical, uninteresting consequences) and explore all possible locations, most of which look exactly the same. Back in your apartment your computer occasionally drops heavy hints in the form of e-mail from your superiors. After solving the first puzzle (with a sense of relief rather than achievement) I returned to the house to find that the solution was practically handed to me on a plate by my boss.

As you move along the street, different categories of establishment are flagged by icons at the bottom of the screen: a bar to your left, for example, or a hotel to your right. Unfortunately all bars look the same from the outside (as do all other building categories) so you have to visit each and every one in your quest. This soon becomes rather tedious since the rewards are not numerous enough to compensate for the disappointments.

Things do hot up later on as you get further into the case, but it is a tremendous struggle against the impulse to reset the machine to get this far.

*The Third Courier* is a disappointment. A slick user interface conceals what is, essentially, a very simple game mechanic which lacks variation in gameplay and ultimately fails to raise the adrenalin levels. Great body, shame about the brain.

● See p.143 for release details.

## LANDSCAPE .....60

Attractive graphics, marred by lack of variety. Very little animation.

## ENCOUNTERS.....65

You meet people almost every step of the way, but few of them have anything interesting to say and most of them look alike.

## CHALLENGE.....78

Will take a long time to solve, but not just because of the puzzles: pace of gameplay is slow and in much of the game trial, error, and exploitation substitute for logic and ingenuity.

## SYSTEM .....68

Very easy on the eye, with clear and simple commands. Unfortunately the underlying game structure is a bit TOO simple...

## ACE RATING 675

**Not a game** that's going to send adrenalin levels soaring. The drama of the scenario isn't adequately translated into dramatic gameplay.



# A REALLY WICKED MIX...

# MegaMix

THE  
**4**  
GAME  
PACK



THAT  
WILL PIN YOUR  
BACK TO THE WALL!

**ocean**

Ocean Software Limited · 6 Central Street · Manchester · M2 5NS  
Telephone: 061 832 6633 · Telex: 669977 OCEANS G · Fax: 061 834 0650



is a hotel.  
er being told  
king barman  
ou're looking  
o play.  
ans involves  
ou question  
s with identi-  
and explore  
which look  
artment your  
hints in the  
. After solv-  
relief rather  
e house to  
y handed to  
  
ifferent cat-  
ed by icons  
to your left,  
ght. Unfortun-  
the outside  
es) so you  
your quest.  
s since the  
to compen-  
  
you get fur-  
idous strug-  
machine to  
  
pointment. A  
t is, essen-  
anic which  
mately fails  
reat body,  
  
se details.  
  
.....60  
iety. Very  
  
.....65  
way, but  
ay and  
  
.....78  
because of  
l in much  
ubstitute  
  
.....68  
e com-  
e structure  
  
drenalin  
enario  
natic

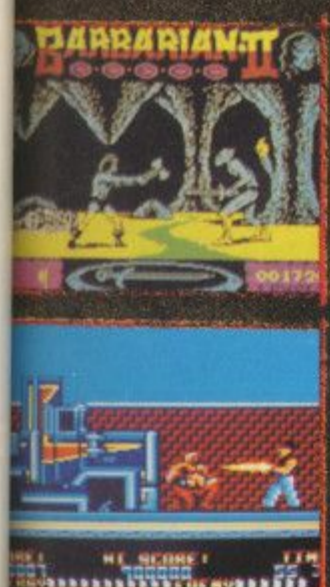



# TWINWORLD



\* Great fun, colourful and addictive too: Overall rating: 81%

A. Smith  
Amiga Format (January issue)

\* It's one of the best 16 bit exploration games around. A great combination of platforms and arcade adventure action. Overall rating: 81%

Computer & Video Games  
(January issue)

\* Twinworld is a lot of fun! Overall rating: 78%

Phil King ZZAP (January issue)

A game created by Blue Byte



Available on ST and Amiga



Screenshots from Amiga Version

**UBI SOFT**

Entertainment Software



The original Leisure Suit Larry was a milestone in computer gaming: it was one of the first titles to achieve significant penetration of the PC-compatible market and was partly responsible for software houses in the UK launching their attack on PC owners.

The formula for all the games is pretty simple. Fat, balding programmer Al Lowe has created his on-screen persona Larry Laffer to pursue his male fantasies in the form of a stable relationship with a good-looking gal. Although

many felt didn't live up to the promise of LSL1. In this new title the humour is more subtle, the locations more interesting, the animation more polished, and the story-line more absorbing. Throughout the game a series of excellent animated cameos include seeing little sheets of paper slip through photo-copiers, being beaten up by your boss, longing for Passionate Patti in the piano bar of the Casino, and seeing several women in various states of undress.

**Watch out – he's back! SIERRA-ON-LINE's animated nerd with an insatiable desire for romantic encounters is once again in pursuit of a mate. This time, he's after Passionate Patti, who's got a thing about Pulsating Pectorals. Is this really just 'good clean fun', we wonder...**

Larry's a one-woman man, however, he can only achieve this status by flirting with every lady he meets, and so far the games have ensured that he meets quite a few.

It's this last bit that makes up the first of the reservations. Previous LSL titles have been entirely innocuous in their pandering to male fantasies, but LSL3 definitely goes one step



**You've got 4000 points to score. Pick up two by looking at yourself in the mirror. You've got to look your best for Patti...**

further and introduces graphics that are obviously designed to be as seductive as pixels can be. This may be easy on the eye, but it's also undeniably exploitative of women's bodies in ways that the earlier games weren't. If that sort of thing bothers you (and I'm not overstating this – the game has very clear mild pornographic tendencies) then the experience is going to be marred as a result.

Another weak-

#### LANDSCAPE .....85

Attractive animated scenes with some very colourful backdrops as Larry scuttles or – if you haven't got a 386 PC – dawdles across the screen.

#### ENCOUNTERS.....70

Lots of them, including some that might be considered in mildly dubious taste. It would be nice if Sierra could beef up the conversations though.

#### CHALLENGE.....80

Easy to get into, but you spend a lot of time covering the same ground. Most of the puzzles are soluble by examining everything in sight.

#### SYSTEM .....80

Slick animated adventuring with occasional lapses of speed. Powerful PC system recommended.

### ACE RATING 890

*Leisure Suit Larry* has become almost a legendary figure in PC gaming. This latest title confirms his...missionary status. It's a pity, however, that the series seems to be heading towards increased female nudity.

need a fast PC with EGA or VGA to get the best out of them. On a bog standard machine, many of the animated sequences are so slow as to be painful. This game isn't as bad as some of the earlier titles (*Kings Quest IV* in particular) but the speed still aggravates sometimes. It's also questionable whether text entry is really suitable for this sort of game: speed of interaction might well be improved with a menu-driven command system.

LSL3 is, despite its shortcomings, a very enjoyable romp and possibly the best of the Larry games to date. Let's hope we don't have to wait too long for the next one...

● See p.143 for release details.

# LEISURE SUIT LARRY III

After his initial success in LSL1, Larry kicked off LSL2 by losing, in the first scene, his conquest of the previous game. He then finds true love on a Pacific Island, but in this latest title the same thing happens all over again. Life with Larry is obviously not a bed of roses, so our anti-hero is forced to abandon his flowery Bermuda pants, don once again his appallingly tasteless leisure suit, and set out on the search for a new companion in the island paradise of Nontoonyt.

With one or two reservations, it's heartening to report that LSL3 is definitely quite a lot more enjoyable than the last game, which

ness in the game concerns the way events are handled by the plot. For obvious reasons, certain things have to happen in sequence, but at the same time it's clearly an advantage to allow the player to wander around as freely as possible. This means that you often attempt to carry out an action, only to be told that you can't do it 'now' but you might like to try again 'later'. This clumsiness was a feature of several early text adventures and nowadays game designers usually find a way round it – in this case Sierra haven't.

The only other criticism is one that applies to all Sierra games, and that's that you really



**This doe-eyed lady is more interested in 'malling' and souvenirs than in your body. Tough luck...**



# MYTH

SYSTEM 3 weaves 8-bit magic

**IT** is very easy, when you have become used to the sort of quality and presentation usual in the best 16-bit games, to dismiss new 8-bit products as inferior titles designed to run on inferior machines. It is also easy to believe that computers like the ZX Spectrum and Commodore 64 have already been pushed to the limit. There has been some very impressive software developed for both of these machines in their long existence. Many programmers have found ingenious ways to get around both machines idiosyncrasies. So surely nobody is going to get anything more out them? Wrong! System 3 have done just that, with Myth.

The idea is that one of the gods, Dameron, has rebelled and begun to change history. It is

## C64 VERSION

To be perfectly honest with you, I've not seen anything as accomplished as this on the humble Spectrum. Having seen the game on the C64 first, I would have expected the programmers to have copped out on this version, and gone for the usual monochrome screens. Not so — not only have they used all the available colours (yes, all eight of them), but I challenge you to discover any major attribute clash. In case you don't know the Spectrum that well, let me tell you, using lots of colour in a game of this type and managing to avoid attribute clash is not only very difficult, it's near impossible.

But, disregarding the tremendous technical achievement, there is just as good a game here as there is in the C64 version. Gameplay is slightly different, mainly in the way that puzzles are solved and each section is finished, but the atmosphere and variety is still there.

The only thing we couldn't check was the soundtrack, which has yet to be implemented, but the all of the other elements were complete and extremely impressive. If you are a Spectrum owner you should buy this game. The chances are you won't come across a better product for your machine.

**GRAPHICS 9 IQ FACTOR 8**  
**AUDIO N/A FUN FACTOR 8**  
**ACE RATING 900**



**Spectrum: Never mind the impressive sprite, just look at those clash-free colours.**

forbidden for any of the good gods to intervene directly in the course of history, so they assign a mere mortal (that's you matey) to travel through several time zones in order to put things right, and ultimately face Dameron himself. The zones you must travel through are Hell, Ancient Greece and the Halls of the Medusa, Ancient Norse, and Ancient Egyptian eras.

In each zone you must complete certain tasks in the correct order to restore the natural course of history and then go forward to the next zone. Unfortunately for you there are a number of creatures and traps in each section which, unless dealt with carefully, will thwart your progress.

To defend yourself against them you initially have nothing but your fists, but other weapons can be collected as the game goes on. The idea is that, as the planned confrontation with Dameron gets nearer, your powers become more and more god-like.

The game itself is essentially a two-dimensional scrolling game with platform elements. Now hold on there, before you turn the page, this isn't just any old platform game, it's the best I've ever come across, and I've played a few platform games I can tell you. So what really makes Myth stand out from the crowd?

Well, the first thing that strikes you is the quality of the animation. You've never seen anything like this on either the Spectrum or the C64. Each figure is given a life of its own. Forget stiff walks, unrealistic jumps, and unconvincing combat — you won't find any of those in this game. Every sprite from the beginning of the game to the end is captivating. As if that wasn't enough, just wait until you start moving the central character. The degree of control that System 3 has managed to squeeze out of the humble joystick is quite incredible. You'll really enjoy the way you can finely adjust your jumps and leaps, or the way you can duck and weave with the sword when you are tackling enemies.

The quality of the graphics alone would be enough to recommend this game, but there are yet more goodies in store. There is enough variety

here to keep even the most easily bored person going. Each section has a very different feel to it, creating its own very special atmosphere. Take, for instance, the vicious lightning while you are fighting aboard a Viking boat in the Ancient Norse era, or the gloomy, echoing halls of Medusa in the Ancient Greek era, both extremely good effects (better executed than anything I have seen in a similar vein). Then there is the way that weapons and items you collect must be used at the correct time and in the right way to complete each section (so you can't just hack your way through). The final confrontation is also very surprising, but you are going to have to find out about that for yourself. Add to this a tremendous soundtrack and spot effects, and you have one of the best 8-bit games ever created.

● Laurence Scotford

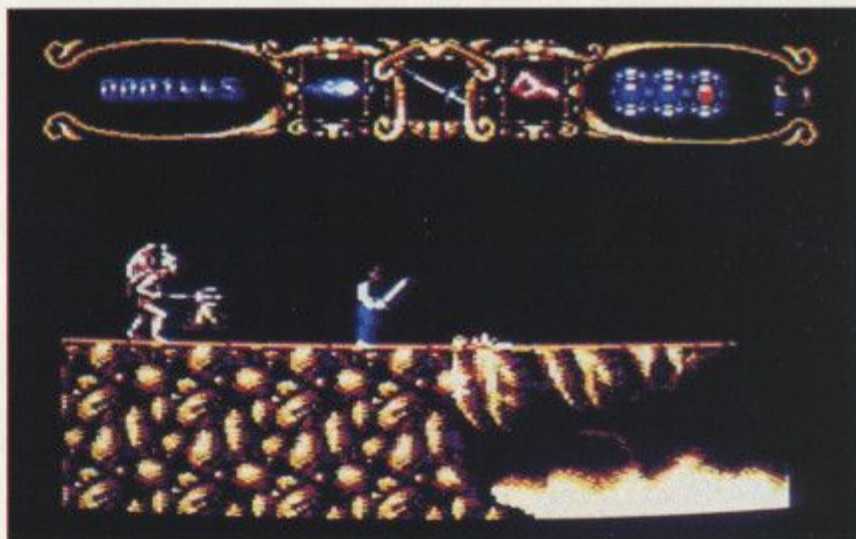

**Oh dear! It looks as if you have been caught between the devil and the deep blue sea.**

## PREDICTED INTEREST CURVE

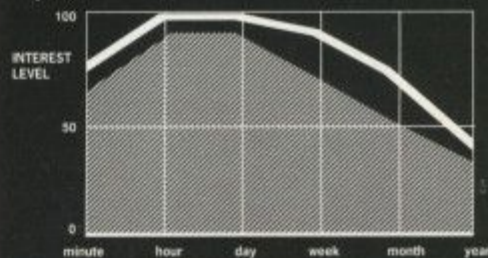

**Might not look very special at first sight. Just wait till you play.**

## RELEASE BOX

**C64/128** £9.99cs £14.99dk **OUT NOW**

**SPEC** £9.99cs £14.99dk **IMMINENT**

16 bit versions to be released in 1990.

## C64 VERSION

This almost looks like an Amiga game that someone has managed to get running on a C64. Superb animation, tremendous sound, and bags of atmosphere make this a must buy. If you want another reason for parting with your cash, it's also huge, and there's lots of variety in there. I was impressed — you will be too.

**GRAPHICS 9 IQ FACTOR 8**  
**AUDIO 9 FUN FACTOR 8**  
**ACE RATING 925**



IF GHOSTS 'N' GOBLINS SCARED YOU OUT OF YOUR MIND...  
 ...THIS'LL SCARE YOU OUT OF YOUR SKIN!

# GHOULS 'N' GHOSTS™

Arthur returns! The fearless knight is back in this stunning sequel to Ghosts 'n' Goblins (voted among the top 10 games of 1986). Three years have passed since the evil ones came to do their dirty work. Now they're back and they've captured Princess Hus, but our valiant knight Arthur is charging to the rescue against a formidable array of gruesome enemies and hairy hazards.

Atari ST, Amiga  
 Spectrum Cassette  
 Amstrad Cassette  
 and Disk  
 CBM 64/128 Cassette  
 and Disk



IAN NAYLOR



**U.S. GOLD**

**CAPCOM™**

Screen shots from Atari ST version.

1989 © Capcom Co., Ltd. All rights reserved.

U.S. GOLD LTD., UNITS 2/3 HOLFORD WAY, HOLFORD, BIRMINGHAM B6 7AX. TEL: 021 625 3388



£2.99 • £2.99 • £2.99 • £2.99 • £2.99 • £2.99 • £2.99 • £2.99 • £2.99 • £2.99 • £2.99

# FOR TOP TITLES



IT'S GOT TO BE...

# ALTERNATIVE

ALTERNATIVE SOFTWARE LIMITED—Units 3-7 Baileygate Industrial Estate, Pontefract, West Yorkshire WF8 2LN. Facsimile: 0977 790243

Available from all good software stores  
including WHSmith and John Menzies.

**WHSMITH** (selected titles available at larger branches;  
subject to availability)

**John Menzies**



# TURBO OUTRUN

US GOLD goes back to the long and winding road with a sequel that's been widely awaited in the hope that it improves on the original!

**APES** evolved into humans, woolly mammoths evolved into elephants and *OutRun* evolved into *Turbo OutRun*. And somehow I don't think that Sega's classic rubber burner got the best deal.

Sega's pioneering racer had everything: cars, girls, sun, surf and a beach-bopping soundtrack. The sequel had everything too – the only trouble was that it was the same everything. Any additions that were made to the second version were at best cosmetic and at worst a detriment to the gameplay: the Turbo button actually made the flashing Ferrari more difficult to handle, while the changing backdrops hardly made an ounce of difference to the action.

## AMIGA VERSION

You didn't spend all that money on Commodore's wonder machine to sit looking at awful still graphics and listen to the disk drive churn.

**GRAPHICS 5 IQ FACTOR 2**  
**AUDIO 4 FUN FACTOR 2**  
**ACE RATING 601**

## ATTENTION C64 GAMERS

C64 *Turbo Outrun* slipped onto our desks as we were going to press. Superficially it feels and plays a lot better than the 16-bit versions – read next month's ACE for a full update.

## PREDICTED INTEREST CURVE

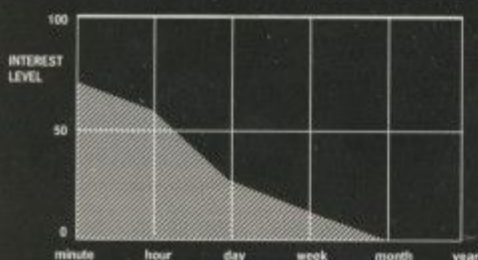

ST **Drive that car...downhill.**

The fact is that the original *OutRun* is one of those games that simply can't be bettered – in the arcades at least – so a sequel hasn't just got a tough act to live up to, it's got an impossible challenge ahead of it. But as far as the home computer conversions go, at least this second stab gives US Gold a chance to make amends for the dismal quality of the original effort.

Unfortunately though, that chance has been wasted. Programmed by I.C.E. (surely in this case it can't stand for In Car Entertainment?), this suffers from all of the original's faults and adds a few for good measure. The most immediately off-putting feature is the awful visual style: the cars and backdrops are irritatingly two-dimensional, creating no feeling



Movement in the ST version is disappointingly blocky, and – even worse – the speed just doesn't impress.

of depth – but there's acute attention to detail in the roadside signs! What a weird sense of priorities!

And to cap it all, there's a massive wait between levels while the program loads the next chunk, which is unforgivable in this day and age and also serves to make the gameplay even more 'stop-start' than it already is.

*Turbo Outrun* has nothing new to offer and doesn't even retread the old ground to any great effect. There was never a great deal of potential in this unnecessary sequel, but I.C.E.'s version has made the worst of a bad job. It's filled the petrol tank with sugar – and failed to sweeten the pill.

● Brian Nesbitt

## RELEASE BOX

<b>ATARI ST</b>	£19.99dk	OUT NOW
<b>AMIGA</b>	£24.99dk	OUT NOW
<b>SPECTRUM</b>	£9.99cs • £14.99dk	IMMINENT
<b>AMSTRAD</b>	£9.99cs • £14.99dk	IMMINENT
<b>C64/128</b>	£9.99cs • £14.99dk	OUT NOW

## ST VERSION

At least the long wait between levels is cut out on the 1040 machines, but otherwise (unfortunately) it's business as usual.

**GRAPHICS 5 IQ FACTOR 2**  
**AUDIO 4 FUN FACTOR 2**  
**ACE RATING 601**



Doesn't look too bad does it? Well, on the page, anyway...





# CHART S FROM US

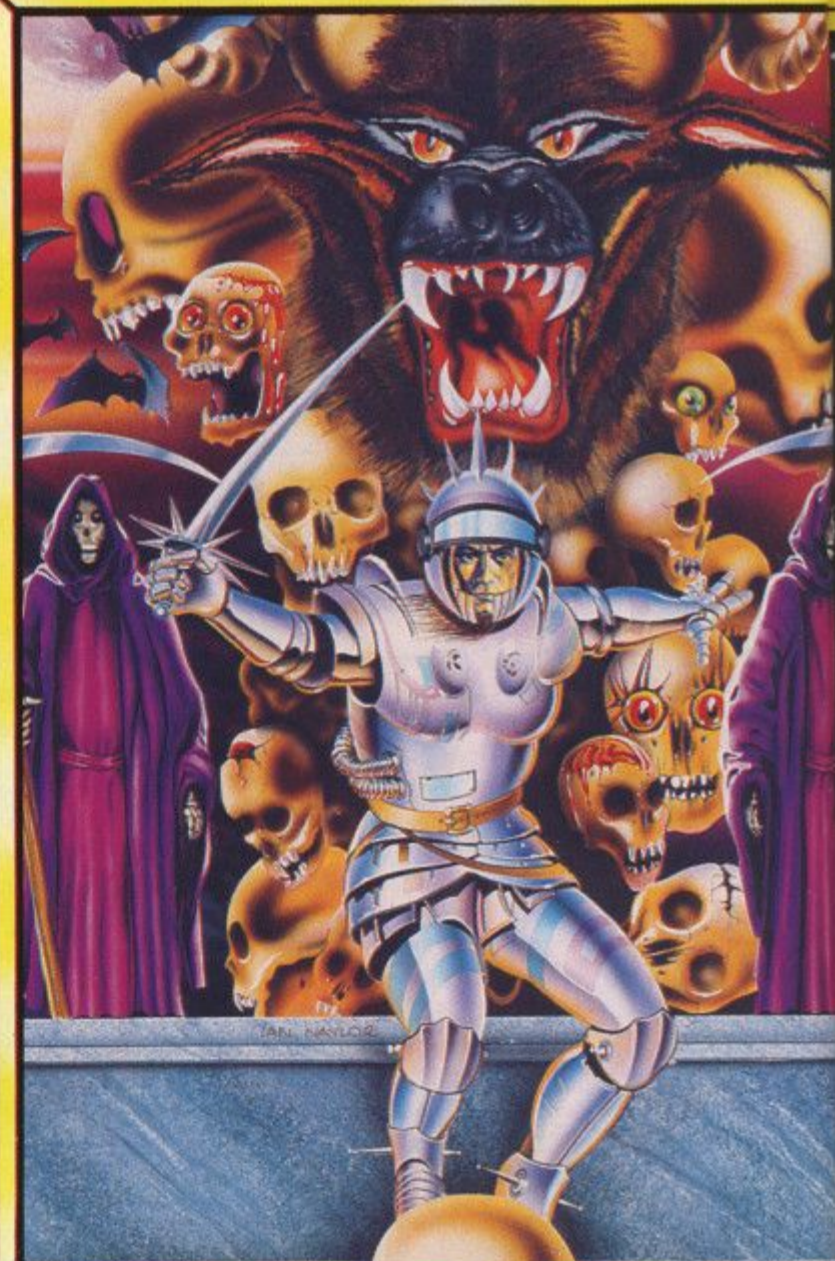

## STRIDER™

**CAPCOM™**

Available on: CBM 64/128 &  
AMSTRAD – Tape & Disk.  
SPECTRUM 48/128K – Tape.  
ATARI ST, CBM AMIGA, IBM PC, DISK.



## GHOULS 'N' GHOSTS™

**CAPCOM™**

Available on: CBM 64/128  
– Tape & Disk. AMSTRAD  
– Tape & Disk. SPECTRUM – Tape  
ATARI ST, CBM AMIGA.

**U.S. GOLD®**

**4 CHART SMASHING  
FOR THE U.S. GO**

U.S. GOLD LTD., Units 2/3 Holford Way, Birm



# SMASHERS U.S.GOLD

A GAME LIKE NO OTHER

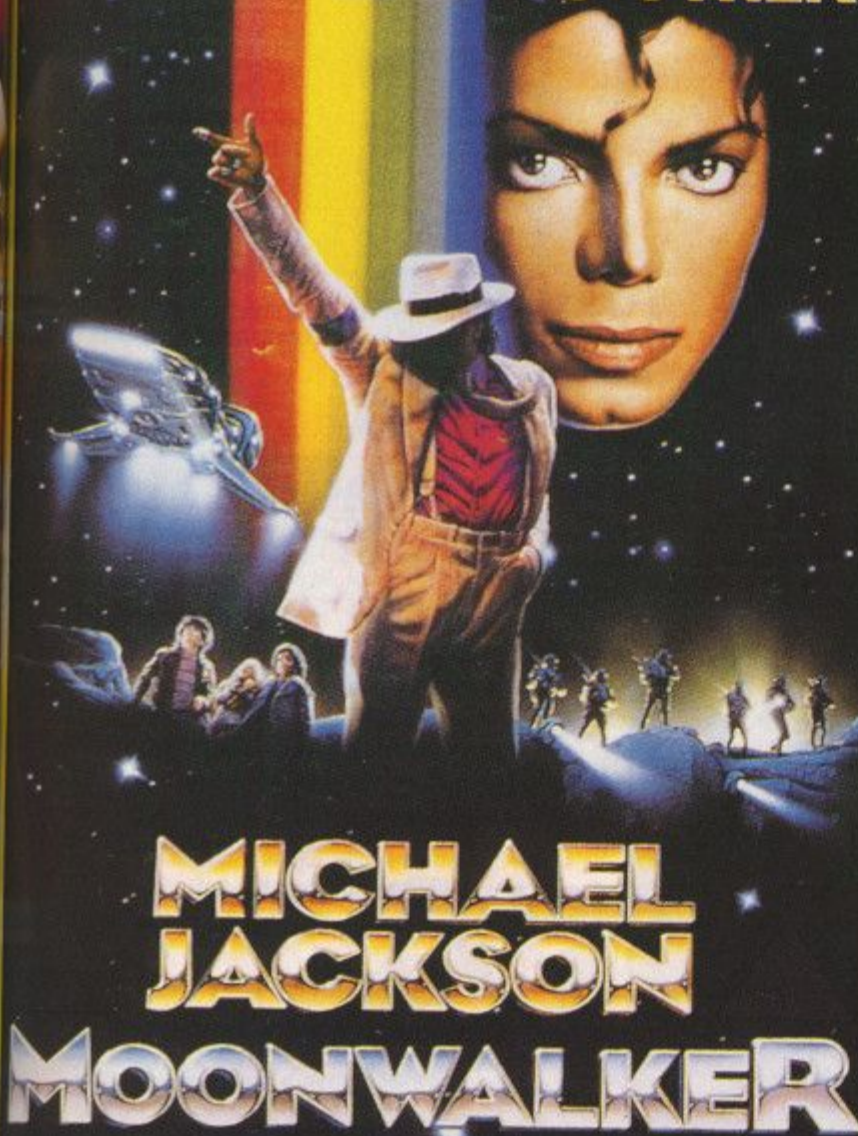

**MICHAEL  
JACKSON**

**MOONWALKER**

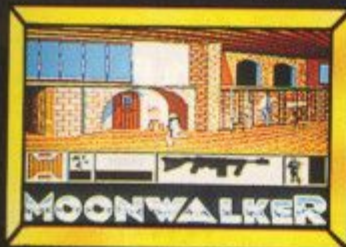

**MOONWALKER™**



© 1989 Triumph International, Inc. All Rights Reserved.  
© 1989 Keypunch Software, Inc. All Rights Reserved.

Available on: CBM 64/128,  
- Tape & Disk. AMSTRAD  
- Tape & Disk. SPECTRUM - Tape.  
ATARI ST, CBM AMIGA, IBM PC.

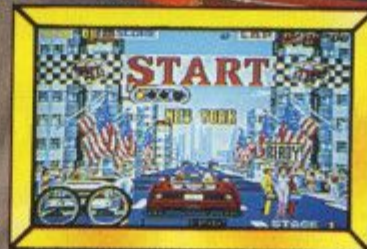
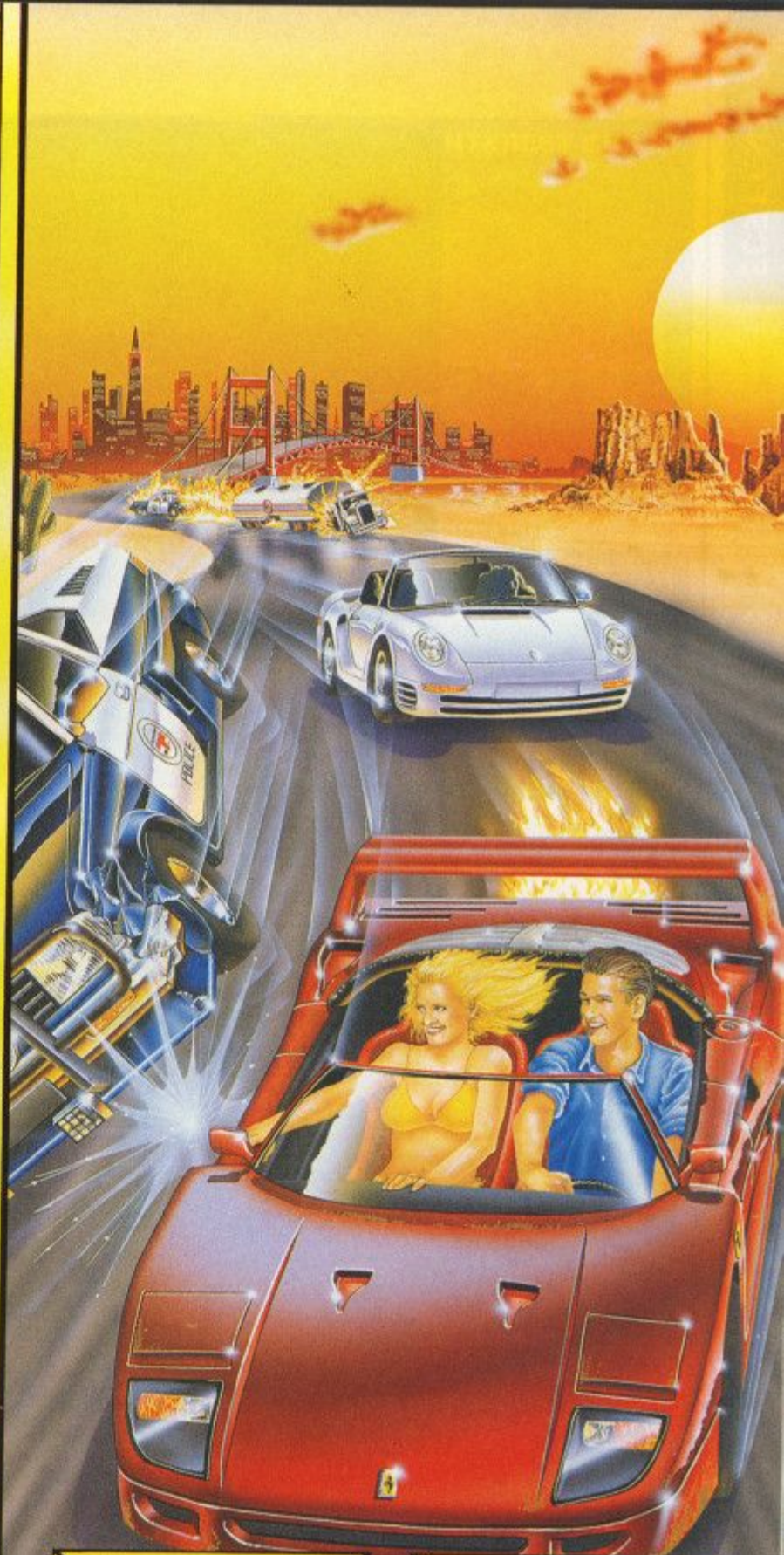

**TURBO OUT RUN™**



Available on: CBM 64/128  
- Tape & Disk. SPECTRUM - Tape.  
AMSTRAD - Tape & Disk.  
ATARI ST, CBM AMIGA.

**HING GAMES DESTINED  
OLD HALL OF FAME!!**



Screen shots from various systems.

Birmingham B6 7AX. Tel: 021 625 3388





# GHOULS 'N' GHOSTS

Grave goings on at US GOLD

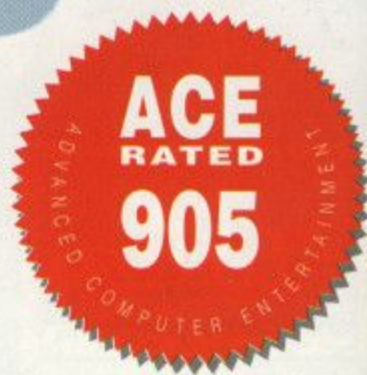

## GHOULS 'N' GHOSTS

is the sequel to Capcom's cutest game ever – *Ghosts and Goblins*. It played like a Grimm Brothers' fairy tale and was the cutest thing you ever saw. Complete with a knight in shining armour, a princess to be rescued, magic spells, and spooky zombies and ghouls welling up out of the grave yard.

At first glance the sequel looks very much like the original – but it is actually a good deal tougher. Five levels of difficulty before you confront Lucifer in the final show down, where you can rescue the princess, may not sound like much – but once you start losing knights before getting anywhere to speak of on the first level, you soon see that you are up against one tough game.

**The giant golden lion bars the knight's entry to level 3. He is difficult to kill because of his habit of leaping all over the screen.**

You begin your quest armed with an unlimited amount of darts that you use to take out the various nasties that confront you as you dash from left to right. The weapon can be exchanged for an axe, time bomb, shield, or knife by grabbing the power ups that appear in the occasional treasure chest.

One of the best power ups to get is the magic suit of armour which gives your knight temporary invincibility, but caution needs to



exercised with the treasure chests. Instead of a power up, certain treasure chests contain a magician who pops up and turns you into a duck – which is no joke when you've got a princess to rescue and half a dozen zombies racing behind you.

If you survive the guillotines and manage to see off the mad boxer mid-way through level one you will come up against the first end-of-level nasty – a long-necked demon with a seemingly insatiable appetite for your arrows or axes. If you get the better of him he drops the key to the next level.

The next challenge is more of a platform test than the shoot 'em up nature of the first





Pump the giant knight full of flak until he drops the key. This opens the door to level 2.

The key's yours. Watch out - level 2 is even nastier!

PREDICTED INTEREST CURVE

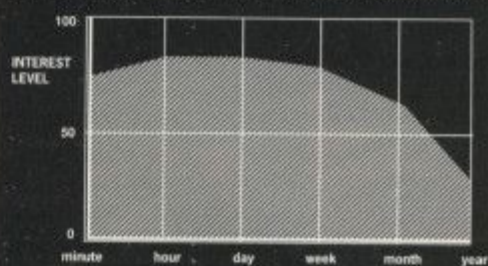

Tough arcade conversion that will take considerable time to master.

ATARI ST VERSION

Very bright and colourful graphics are enhanced by the use of a black background. The game is very similar to the Capcom coin-op. Fast and unforgiving in its game play. Good use of sound effects and a suitable tune make for a first rate ST arcade game.

GRAPHICS	8	IQ FACTOR	8
AUDIO	8	FUN FACTOR	9
<b>ACE RATING 905</b>			

RELEASE BOX		
ATARI ST	£19.99dk	OUT NOW
AMIGA	£24.99dk	IMMINENT
SPECTRUM	£9.99cs • £14.99dk	IMMINENT
AMSTRAD	£9.99cs • £14.99dk	IMMINENT
C64/128	£9.99cs • £14.99dk	IMMINENT

one. A series of intricate rope bridges have to be negotiated - without falling through the various holes that appear should you place your knight's foot on a rickety section of ladder. You won't actually fall that far - just below you is a pit complete with giant snails and other ghastly creepy crawlies, all crying out for lunch. Jumping out of the pit back onto the rope bridge requires very deft use of the joystick - you have to jump slightly upwards and then quickly change direction to enable your knight to secure his footing on the pit that is constantly moving.

If you survive this level and make progress in the following three you will begin to appreciate the fact that success depends on speed. The knight needs to be constantly moving forward - not just to avoid the ghouls and other nasties that are constantly welling up out of the ground, but also because there is a time factor to be taken into account. Dally too long on any level and you are likely to be told that you have "Run out of time".

It is the graphics that set *Ghouls 'n' Ghosts* a good few degrees above the dozens of 'rescue the princess' arcade adventures that have done the rounds. The detail of the knight and of the zombies and ghouls, their movements, and the backgrounds make for a very pretty

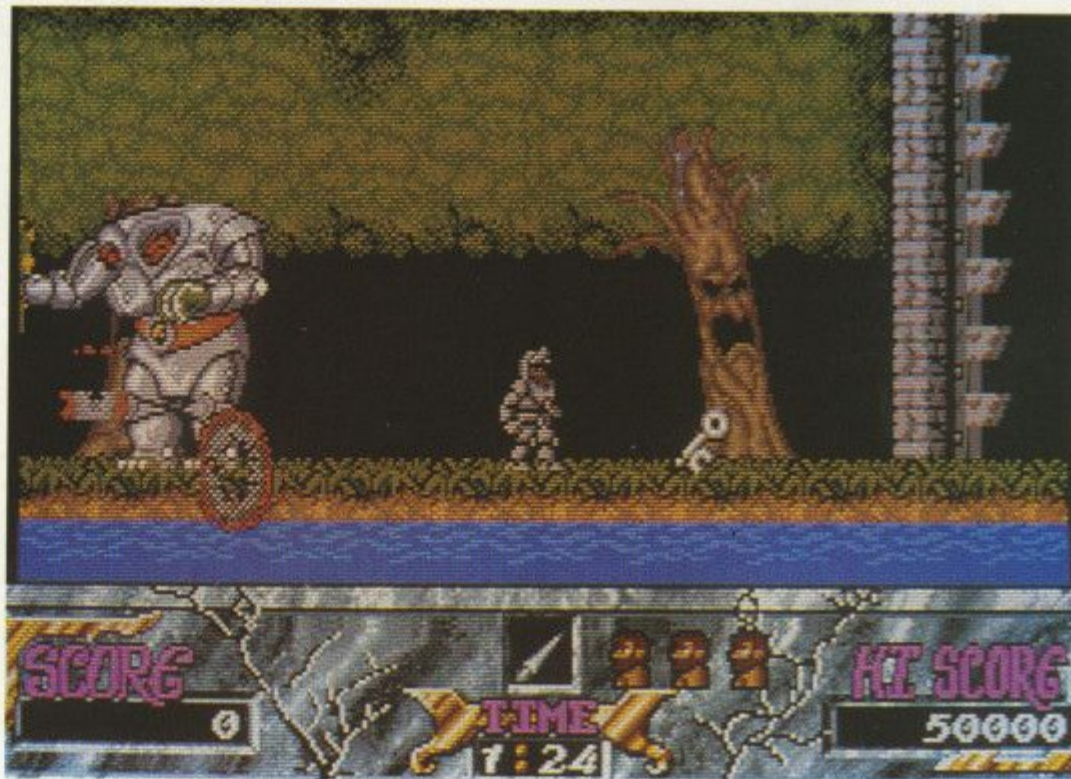

arcade game. It turned heads when it appeared in the arcades and appears to be converted to a high graphical standard in all of the home versions ACE has seen.

But this cuteness should not blind gamers to the toughness of the challenge provided by *Ghouls 'n' Ghosts*. This is not for the uninitiated. You will find it addictive and enjoyable but be prepared to invest a goodly number of days - even weeks - of gameplay if you are serious about defeating Lucifer and rescuing the princess.

● Eugene Lacey

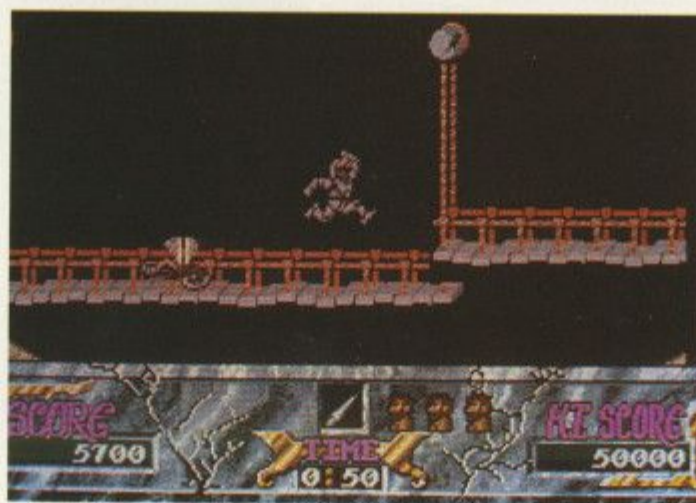

Don't stand and fight - this mad boxer in the middle of level one is tougher than any of the end-of-level nasties. So scarp-er...



# MOONWALKER

Wacko Jacko's soft shoe shuffle put US GOLD in the limelight.

**MICHAEL** Jackson's launch on computer had all of the razzamatazz that you would expect to be associated with the world's number one pop music megastar.

US Gold did Jacko proud in the hype department with a mega bash at London's trendy Limelight Club. There was booze and food in abundance, dancing till dawn, a cabaret spot by Rik Mayall, and even a Michael Jackson look-a-like doing his stuff on stage for the hundreds of reviewers, distributors, retailers, and buyers who crammed in to the nightclub for the best PR do at the PC Show.

Whilst all this partying was going down, Emerald Software were putting the finishing touches to the game across the Irish Sea in Wexford.

Their brief was to follow the Moonwalker film as closely as possible – not easy when you consider quite how ludicrous the storyline is. Get this: MJ is trapped in a maze and must find eight pieces of a bunny rabbit suit before hopping on a motorbike, whizzing through a city destroying bags of drugs, shooting it out with Mr 'Drugs Baron' Big's Storm Troopers in a night club, and finally rescuing Katy, the little girl who has been kidnapped by the drug dealers. It all ends with a shoot out in Mr Big's compound where Jacko has to destroy his giant laser cannon before turning into a space ship and shooting off to the stars where, presumably, he belongs.

This far fetched derring-do doesn't matter a jot in the film as it merely serves as a platform for the spectacular song and dance routines. Computer entertainment has got a long way to go before it can rival the best of Hollywood's film makers, let alone Michael Jackson's feet, and so as a game structure it appears a little, well, banal. Hardly the most appropriate label for a superstar.

That, however, was the brief and you can't blame the programmers for it. It is also possible that they were hamstrung by Michael Jackson's publishers. The press release reads 'Michael cannot die. Michael cannot be seen to die on screen. No violence! Michael Jackson is very anti-violence, so there are no weapons in the game until the 3rd level'.

'No weapons until the third level??'. What is supposed to happen then? Does MJ cease to be anti-violent for this level? Surely some mishtake. Shooting it out in a nightclub with a bunch of storm troopers seems just a teensy bit removed from non-violence. It does, however, make for one of the best bits of the game.

Amazingly, in the face of all this nonsense,

Emerald have produced a half decent game. It is not a game for hard core gamers, veterans of tough arcade adventures, and state of the art shoot 'em ups. It is however well suited to younger players – particularly if they are MJ fans.

The opening maze game is Pacman like – combining the appeal of collecting the various bits of the suit and seeing the jigsaw puzzle take shape with the minor tactical diversion of avoiding your fans, most of whom have varying movement patterns and strategies. It's a shame there are no power-ups in this level – as it would have greatly improved game play if you could have had a go at some of the nasties. But then it's not level three so you are not allowed to be violent yet. The best you can do when the going gets tough is run away, but you have a limited amount of energy for this so it's best saved for the really tight corners.

Once you get the suit, hop on the bike, and enter level two you are initially disappointed to find that it is pretty much identical to the previous level. However, there are more things to collect though – ten emeralds to be precise – before you can metamorphose into the Stratos Car. You are racing against a time limit so you have to make use of the radar panel to locate the emeralds and gather them in the quickest way. Unlike most computer game radar devices this one does actually need to be used and does also work. Bonus points are earned by destroying the bags of drugs by driving over them.

The nightclub scene is a welcome relief from the maze levels. At last you can grab a gun and start blasting the nasties that appear at the windows in this horizontally scrolling

level. The graphics are far superior in this section. Jacko walks and runs with some of the elegance that you would expect from the best dancer in pop music.

An even better shoot 'em is to be had on the final screen when you attempt to destroy Mr Big's giant laser. All anti-violence preciousness goes out the window as the game turns into a good old fashioned shoot 'em up. Jacko is now a robot and has to shoot all of the guards before he gets to the giant laser.

Only four levels of play – but reasonably absorbing game play – result in a game that's a definite must for MJ fans (a valuable piece of memorabilia?). Game play is more suited to



Level One and you're all kitted out with your bunny suit.

younger players – which is fine because most of MJ's fans are. The verdict for everyone else, however, is that the game is definitely not a 'thriller', but nor is it totally 'bad'. Not something, in short, that you'd make a long trek for.

● Eugene Lacey

### ST VERSION

Disappointing sound track. The ST is capable of a lot better than this and when you consider the material Emerald had to work with there is no excuse for the awful 'plinky-plonky' rendition of the 'Bad' album title track. Graphics also leave a little to be desired on the first couple of levels. Technically not one of the best ST gamees around.

GRAPHICS	7	IQ FACTOR	5
AUDIO	4	FUN FACTOR	6
<b>ACE RATING 650</b>			

### RELEASE BOX

AMIGA	£19.99dk	IMMINENT
ST	£19.99dk	OUT NOW
IBM PC	£24.99dk	IMMINENT
SPEC	£9.99cs £14.99dk	IMMINENT
AMS	£9.99cs £14.99dk	IMMINENT
C64/128	£9.99cs £14.99dk	IMMINENT

### PREDICTED INTEREST CURVE

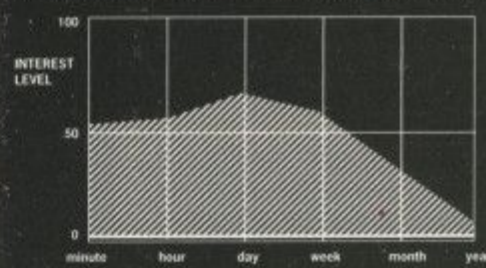

Not enough variation in gameplay to raise the interest levels high either in the short or the long term.



Level Two: on yer bike.



# Fight for your life!

Learn the fighting skills of 'jeet kune do', Bruce Lee's own deadly form of martial arts.

Through practise in the gym against punch bags, then with other students, you gradually acquire the skills to take on the vile Master Po and the thugs of his drug cartel.

The special use of Artificial Intelligence lets your opponents learn your weaknesses and counter attack.

You can never be assured of success.

Available for IBM PC and compatibles. Supports 16 colour VGA, 16 colour EGA, Tandy 1000 and CGA graphics.

Coming early 1990 for Commodore Amiga and Atari ST.

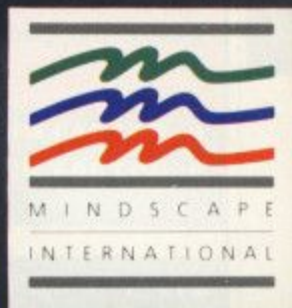
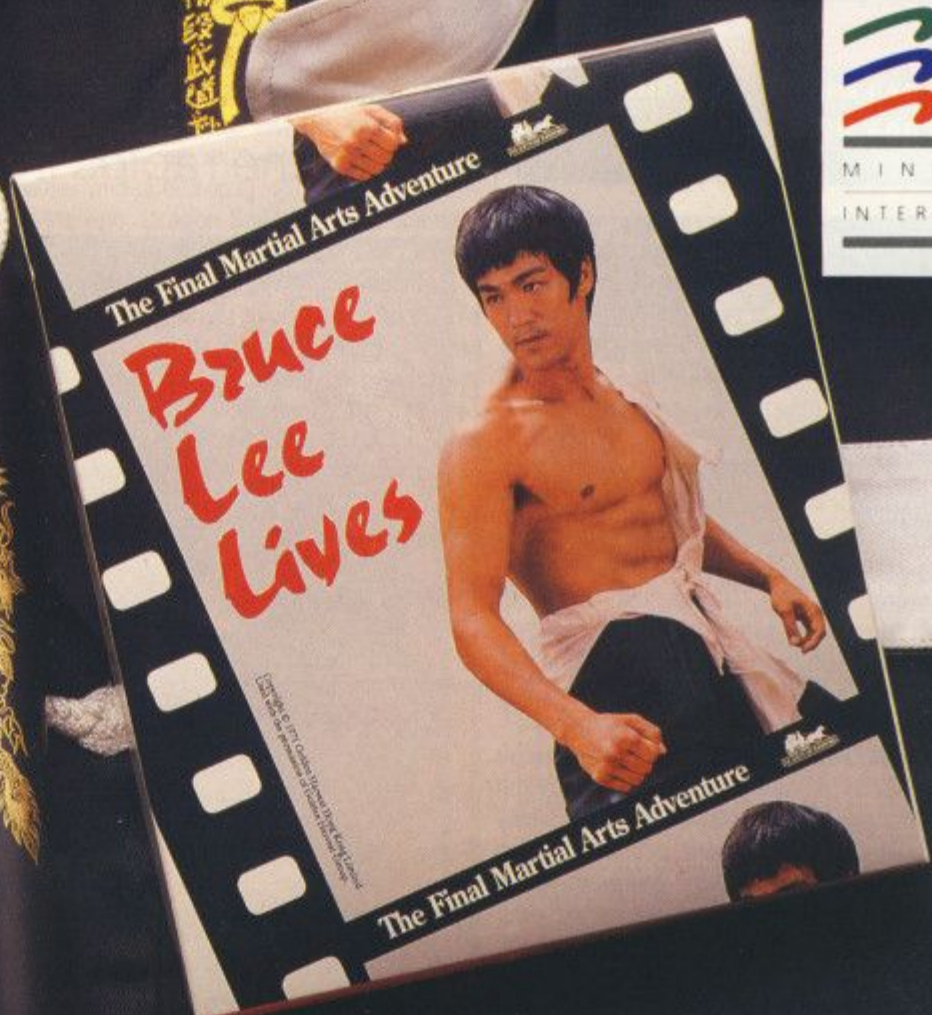

# M I N D S C A P E

For further information on Mindscape products and your local Dealer, contact:  
Mindscape International Limited, PO Box 1019, Lewes, East Sussex BN8 4DW. Tel. 044 486 545/547.



# TOOBIN'

DOMARK shoot the rapids in a rubber ring

**JET** and Bif are two reeeel cool dudes, who like nothing better than stripping down to some crazy shorts, hopping on their toobs and launching into the nearest river. One bright Californian day, they decide to do just that – but this time they picked the wrong river...

The wrong rivers, to be more precise. Sick of the ponds back home, they decide on a spot of globe-trotting in search of some real action. Their paddling japes take them along the Amazon, Yukon, Nile, Rio Grande and Colorado; and they're pretty crowded rivers these days. In fact, Jet and Bif have to be extra cool to get through the kind of hazards they face on this toob trip.

For example, each river has its own unique wildlife, such as hippos, crocs, submerged trees, snakes, fishermen's crazy floats, submarines and (in a nightmare section) a hand that hacks at you with a knife. There are plenty more obstacles, all of which will deflate your rubber toob; and if it all gets too much, you can get rid of them with an expertly lobbed Coke can. Then there are hazards on the bank. Trees topple and fall into the water, anglers launch lines at you, natives use you as target practice for their blowpipes, sewage spills seep sneakily towards you. In canyons, rocks fall in the water far too close to your Bermuda shorts for comfort.

It's not all bad, though. If you're a particularly deft toob-manipulator, bonuses lurk around every corner. Pass through gates without touching them for big points; collect cans to stock up on ammunition; chase after beach balls to speed you up, and collect patches for extra lives. In fact, if you manage to collect tons of points and avoid being killed, you'll qualify for extra-hard cool status.

At the end of each sub-stage you make a decision to paddle left or right through a canyon: choosing one route over the other determines which sub-stage you face next – and some are definitely more difficult than others! This is just one aspect of the game which makes it all the more enjoyable to come back to time and again.

Like the arcade parent, the home versions of *Toobin'* are great fun. The control method has been translated well from the two-button



**Wobbling on his inflatable, Jet can throw Coke cans to remove dangerous obstacles and reveal bonus objects. Running into a tree, twig or anything else that's sharp will puncture his rubber ring and drown him.**



**In two-player mode, Jet and Bif battle it out for points and pride. The river seems a whole lot smaller when there are two toobs wobbling around.**

coin-op system, and it only takes a minute to get used to. If you get bored of the solo game (which will take a long time), there's always the two-player option. Not only does this halve your credits, it also means you can push your mate into the nearest twig and pinch all the Coke cans before he can grab them. Whether or not you've played the coin-op, take a look at *Toobin'*, because it's one of the most enjoyable games around this Christmas.

● Gordon Houghton

**You're not alone out there on the river. Shore geeks pelt things at you, crocodiles chase you from behind, hippos waddle up and gobble you up. Who's cool now?**

## AMIGA VERSION

Detailed, colourful graphics (almost full-screen scrolling), great music and heaps of playability make this a brilliant conversion of the coin-op – even if it's not completely accurate. Just the kind of game to cheer you up

**GRAPHICS 8 IQ FACTOR 4**  
**AUDIO 8 FUN FACTOR 9**  
**ACE RATING 880**

## RELEASE BOX

ATARI ST	£24.99dk	IMMINENT
AMIGA	£24.99dk	OUT NOW
SPEC 128	£9.99cs • £14.99dk	IMMINENT
AMSTRAD	£9.99cs • £14.99dk	IMMINENT
C64/128	£9.99cs • £14.99dk	IMMINENT
IBM PC	£24.99dk	IMMINENT

## PREDICTED INTEREST CURVE

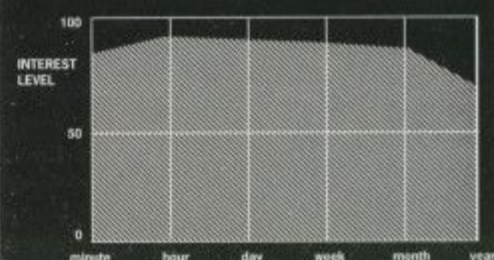

Fun from the start, the graded difficulty level, two-player option and large number of levels guarantee its lastability.



# DRAGON SPIRIT

Does Domark's Dragon do justice to the coin-op?

**DRAGON** Spirit is a relatively obscure and very tough coin-op which takes the vertically scrolling shoot 'em up theme into the realms of fantasy.

Eight completely different levels lie ahead of you, populated by unique opponents — all of whom will reduce your life-bar by one unit. Lose three units and you forfeit a life. At the end of each stage there's a fairly typical confrontation with a pretty awesome enemy which is very tough to kill.

Your basic weaponry consists of limitless bombs and the ability to spit fire-goblets, but this ammunition can be enhanced by bombing eggs on the ground. Blue eggs give you an extra head, and red ones give you an extra power unit; eventually, you can work your way up to a powerful flame-thrower.

Other enhancements come from killing flashing enemies. These include extra points, shields, mega-flame, multi-directional fire, homing flames and speed-ups.

In the end, Dragon Spirit is just a standard vertically scrolling shoot 'em up, but using a dragon as the main character rather than a fighter plane or spacecraft is a nice touch. All versions are characterised by poor sound effects, and that's the only real let-down. Domark's conversions contain all the features of the original coin-op and if you liked that, you should look at this.

● Gordon Houghton

## SPECTRUM VERSION

Probably best played with keys, since with a joystick you can't fire and bomb at the same time (unlike the ST and Amiga versions). The sprites are nicely defined and animated, and the speed and toughness of the arcade game are well captured here.

**GRAPHICS** 8    **IQ FACTOR** 4  
**AUDIO** 4    **FUN FACTOR** 8  
**ACE RATING** 795

## ATARI ST VERSION

Smooth vertical scrolling and a pretty mean difficulty level make for addictive gameplay; however, the playing area is a bit small (compensated for by a sideways 'push' scroll), making it harder to anticipate attack waves. Still a good conversion, though.

**GRAPHICS** 8    **IQ FACTOR** 4  
**AUDIO** 5    **FUN FACTOR** 8  
**ACE RATING** 795

## AMIGA VERSION

Probably the easiest version of them all - though it gets a lot tougher around levels five and six - and the dragon is a little slow to respond at first. It comes with a pleasant title tune, but more should have been made of the firing and bombing effects.

**GRAPHICS** 8    **IQ FACTOR** 4  
**AUDIO** 5    **FUN FACTOR** 8

## PREDICTED INTEREST CURVE

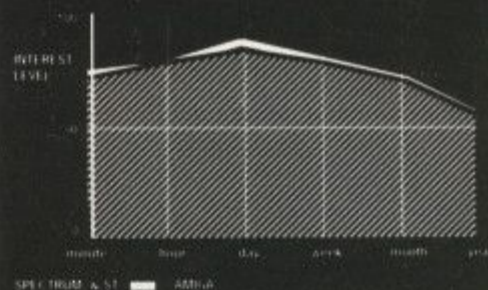

Initial frustration gives way to addiction as you learn to pick up extra weapons and avoid the predetermined attack patterns.

## RELEASE BOX

<b>ATARI ST</b>	£19.99dk	OUT NOW
<b>AMIGA</b>	£19.99dk	OUT NOW
<b>SPECTRUM</b>	£9.99cs • £14.99dk	OUT NOW
<b>AMSTRAD</b>	£9.99cs • £14.99dk	IMMINENT
<b>C64/128</b>	£9.99cs • £12.99dk	IMMINENT
<b>IBM PC</b>	£24.99dk	IMMINENT

*St. Louis*

*Hawaii*

*Paris*

*Tokyo*

# World of Flight

Travel the globe with the best in simulation software; UFO™, Flight Simulator™, ThunderChopper™, Jet™, and Stealth Mission™. Discover the world with Scenery Disks, Flight Controls I, and other supplements to our integrated flight line!

UFO, Flight Simulator, ThunderChopper, Jet, Stealth Mission, and Flight Controls I are trademarks of SubLOGIC Corp. IBM screens shown. Other computer versions may vary.



# ROLLER COASTER RUMBLER

TYNESOFT'S Corkscrew Simulator

**WATERY** eyes, heaving guts, white knuckles. Know the feeling? If you do you're probably one of the millions of people who go on roller coasters for the express purpose and pleasure of turning their internal organs upside down. Most of the theme parks have closed down for the winter, so if you're still bent on pursuing the thrills and spills of the corkscrew, you'll just have to rely on your computer simulation of all that rough and tumble fun.

As solo player or one half of a lean, mean team of two, you're equipped with nothing but a bog-standard roller coaster car and a couple of bazookas strapped on to the front and back. The basic idea is simple; just blast the hell out of any obstacles that appear on the vector graphics track.

Targets range from multi-coloured balloons dangling innocently from the roller coaster structure, to huge airborne ships dropping missiles all over the track. In between, there's a whole selection of hazardous geometric objects — exactly what they're supposed to be is anybody's guess — placed at intervals along the line. Occasionally rhomboids and cylinders completely block your path. If you don't manage to shoot them in time, they'll do a limited amount of damage to your car. Hit too many and your damage meter plummets down to zero sending the roller coaster completely off the track.

The track itself is viewed in first person perspective from either the front or the back of the car. You travel at standard speeds (slow uphill, very fast downhill) unless you alter them using the relevant keypresses to accelerate or brake.

The objective on each level is to hit a specified amount of targets in a specified period of time. If the timer runs out or you run out of bullets, the run is over and you've lost the game. Finish with time to spare and you move on to the next track.

If you get bored of just going round and round the roller coasters, there's actually an extra option on the Amiga and ST versions, which lets you leave the park and go off into the surrounding landscape to blast whatever takes your fancy. The PC version even lets you try out a monorail ride.

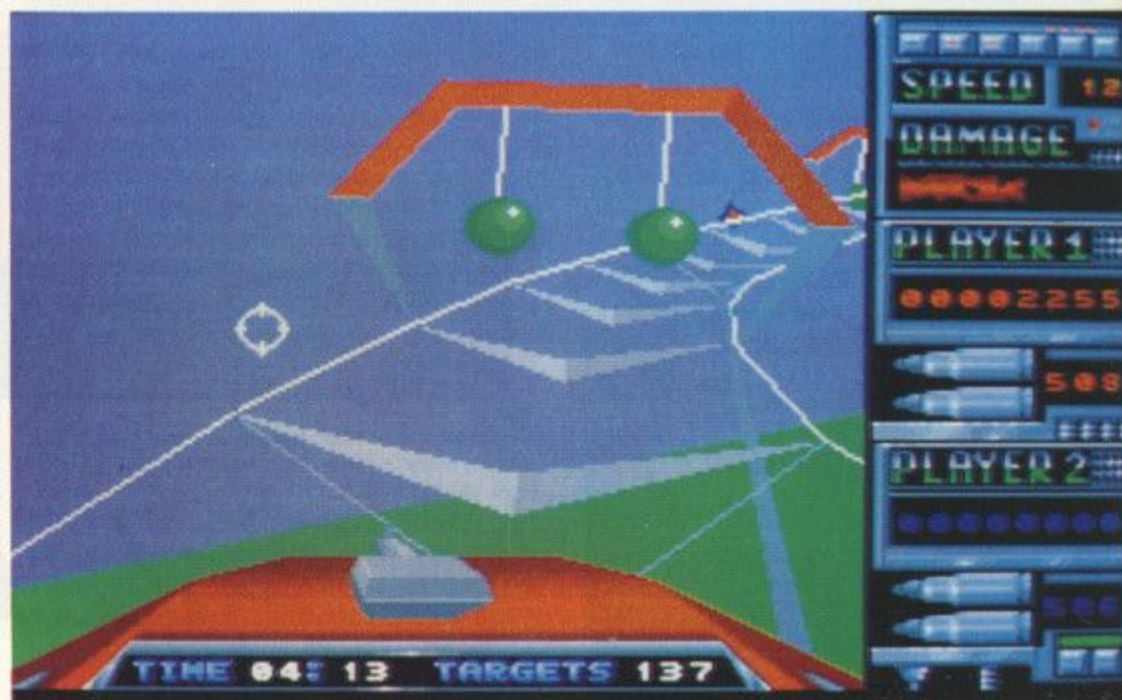

Frightened yet? No, nor were we.

## PREDICTED INTEREST CURVE

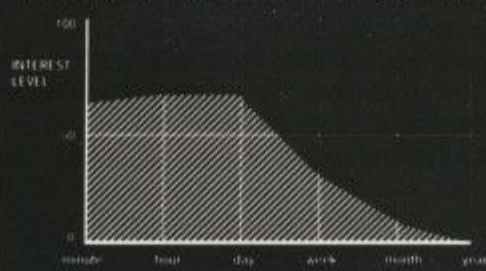

A roller coaster simulator which just lacks that extra radical rumble.

The package comes with its own health warning: 'Roller Coaster Rumbler is only for the totally radical rumbler!'. All I can say is that the totally radical rumbler must have a very powerful imagination. Jerky 3D vector graphics do not adequately capture the excitement of a roller coaster ride. It's difficult to blanch at hair-raising turns and death-defying dips when the track in front of you is an unrealistically weedy wireframe affair.

It's a pity because all the basic elements of a good game are here; different tracks, lots of

obstacles and even a convincing sense of speed (only if you use the speed up option). The movement is very jerky, especially if you choose off-track mode, and sound effects are uninteresting (though you get a decent soundtrack tape thrown in) but ultimately it's on the vector graphics that the roller coaster crumbles. Quease-factor is what *Roller Coaster Rumbler* definitely lacks.

● Kati Hamza

## AMIGA VERSION

Neat presentation and rumbling heavy-metal style soundtrack tape can't make up for the hair-raising excitement that this so patently lacks.

GRAPHICS	4	IQ FACTOR	2
AUDIO	4	FUN FACTOR	6
<b>ACE RATING 463</b>			

## RELEASE BOX

ATARI ST	£19.95dk	IMMINENT
AMIGA	£19.95dk	OUT NOW
C64/128	£9.95cs • £14.95dk	IMMINENT



# DRAKKHEN



ATARI ST  
AMIGA 500/1000/2000  
PC & COMPATIBLES





THE MOST EXCITING  
FILM OF THE YEAR  
NOW FOR YOUR HOME MICRO.



**ROBOCOP OUT NOW**

"This is definitely the best film to date, and is utterley superb. Buy it on its own right - don't miss it!"

Small text at the bottom right of the yellow banner.



# ROBOCOP™

THE FUTURE OF LAW ENFORCEMENT

**LONGEST RUNNING No 1**

computer game is back on the climb for Christmas - The metal man takes no prisoners in the pursuit of thrilling action -

**PLAY THE COIN-OP  
FIRE UP THE COMPUTER GAME  
PART MAN ... PART MACHINE  
ALL COP ... ROBOCOP**

ROBOCOP™ & © 1987 ORION PICTURES CORP. ALL RIGHTS RESERVED.

Also available for **AMIGA £24.95** and **ATARI ST £19.95**

SPECTRUM  
**£8.95**  
COMMODORE  
**£9.95**  
AMSTRAD

# ocean



# TWINWORLD

Can a jumpy-jumpy, collect the objects, thwart Ultimate Evil, teeny-weensy sprite-typ scenario still cut the mustard in 1989?

UBISOFT surprise us...

**ANY** set of instructions that starts off with the heading 'The Legend of the Sacred Amulet' must surely strike terror into the heart of the majority of computer gamers. I ask you. The 'Listen with Mother' school of game design.

Yup, we're scarcely in the Advanced Computer Entertainment market here, with a little man jumping around collecting 24 pieces of some stupid magic amulet that an evil something or other has scattered to the four winds. Fail and Evil (yawn) will win and all the good little pixies will have their private parts dismembered. Help!!!!

Nevertheless, apart from the astonishingly bad quality of sampled music at the start of the game, as far as jumpy-jumpy games go, I quite enjoyed *Twinworld*. And I'll tell you this much – it's big! Two ST discs worth of jumpy-jumpy? When the sprites are this small, that's a lot.

The scam is that your nicely animated sprite, Ulopa, has to battle his way through the lands infested with evil, killing monsters for points (and points make prizes if you summon the merchant) – trying to make difficult jumps across lava filled pools, armed only with three types of magic bubble.

You'll find you have a limited number of these, but extra can be obtained all round the shop by picking up the magic potions that are littered around the levels.

Each level has an upper bit on the land and an underworld bit – which often can only be accessed by having the correct key to get into a particular door. Look out for the odd bolt-holes, however, which you can use to get to the underworld without using keys.

This underworld part is important, as it runs parallel to the upper bit – so if you find a jump that is just that little bit too much to take, on the surface – chances are you're going to

have to go back and take the tube under the obstacle to come out on the other side.

Such a banal scenario must live or die by the implementation – and I'm happy to say that, on the whole, programmers Blue Byte have made a great job, capturing an almost *Super Mario* feel in *Twinworld*.

The physics of your little hero appear to have been coded very well, so he has weight that is sensibly governed by gravity and momentum. This is in turn exploited by some of the puzzles – you make a jump, say, and if you don't reverse thrust straight away, it's the lava for you, m'lud!

Firing the bubbles isn't exactly straightforward either, with the exact parabolic trajectory depending on whether you're jumping up, down, standing or crouching – you'll find the bonus you get for zapping a monster will vary depending on what type of bubble you use, too – the species being easily changed by a tap on the space bar.

Some of the jumps are difficult – some of the puzzles are a bit infuriating – and you can proceed in the sure knowledge that if you haven't picked all the useful items up before you get to meet the chief baddy, he'll probably pummel you to bits anyway.

But if you are the sort of person that craves the kind of agony/ecstasy gratification that this sort of game can deliver, however limited that sub-set of human beings might be, then this will undoubtedly be an essential purchase.

Those of us with more eclectic tastes and



Uncluttered screens and clear graphics in *Twinworld*.

less money, however, would probably still rather go for *Rick Dangerous* or wait for *Dynamic Debugger*.

● John Cook

## RELEASE BOX

ATARI ST	£19.99dk	IMMINENT
AMIGA	£24.99dk	IMMINENT
No other versions planned		

## ST VERSION

No serious technical stuff here, and the sound could have been a lot more polished. However, the basic animation mechanics are slickly done.

GRAPHICS	8	IQ FACTOR	7
AUDIO	5	FUN FACTOR	7
ACE RATING 794			

## PREDICTED INTEREST CURVE

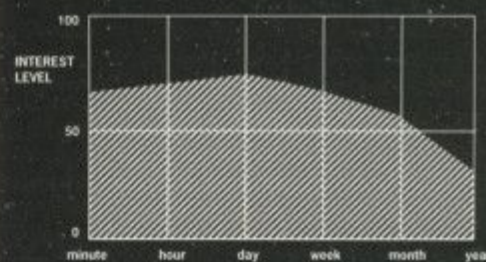

After gawping in disbelief at the old-fashioned scenario, old-fashioned playability gets the upper hand.



You can't hear the music in this shot – just as well!



ACTION & ADVENTURE ALL THE WAY - NILE STYLE

# DAYS OF THE Pharaoh™

THE FATE OF AN ANCIENT  
CIVILISATION RESTS IN  
THE FORTUNES  
OF YOUR  
FUTURE.



Screen Shots From Amiga Version

"It's deep absorbing fun to play."  
"The graphics are excellent."  
"In an increasingly popular field of interactive strategy, this is a must for fans of this style."  
COMMODORE USER.

"An excellent product... Great in-depth game play."  
"Will keep you enthralled for weeks..."  
"Some very clever and original touches."  
THE GAMES MACHINE

"Pharaoh combines effective graphics and superb sound in a very playable game. From the word go, it offers a wide variety of options and playable sub-games. If you fancy something different, take a look."  
AMIGA ACTION.

"The graphics are superb..."  
ST FORMAT.

On the night of the Pharaoh's death, Amon-Re, the Sun God, rescues one young prince from the wrath of Seth, God of the Desert and Evil, bringing him to the fellahs amongst whom he is raised. You are this young Egyptian prince, royal blood flows in your veins and ambition and intelligence move you into trade as a merchant - your opportunity to escape the life of a servant. However, as your wealth increases and position in society rises, evil jealousy threatens your life, it is then that princely courage protects you against your enemies. The struggle to regain your birthright is a life's journey of adventure and action.

CBM AMIGA £24.99

ATARI ST £24.99

IBM PC £24.99



**Rainbow Arts**

A Chip production for Rainbow Arts

FROM THE CREATORS OF





# BUSHIDO

FIREBIRD's beat-em-up arcade adventure

**BUSHIDO** is a Japanese term meaning 'the way of the warrior' - a kind of military ethics for early feudal Japan. In the ancient oriental province of Shimosa, two clans, the Taira (nasty) and the Genji (nice - your lot, obviously) are battling it out to decide who's best.

With typical bravado you decide that a lone fighter is the best option. You can choose one of eight different characters: they don't look very different on screen, but, as you discover after a while, they do behave in genuinely different ways during the game. Some characters are better at fighting (the Mountain Warrior, for example), whereas others are more skilled in guile (such as the Buddhist Monk).

After training your infiltrator you unleash him on the Taira fortress. This is a flick-screen environment but Graftgold have added a bit of scrolling, which makes the rooms seem larger than normal and allows a bigger, more detailed main character - an unusual idea and one which works well. If this character gets killed, his magical belt will transport him back to base to recuperate - but he will have lost valuable time.

Most rooms contain special items to help you in your task: food, weapons, special

potions and wands (experimentation needed), and keys which to the next stage. When you're not searching and solving, you're battling it out with the opposition.

Truly interactive 3D forced perspective games have never worked too well on the 64; oldies like Fairlight and Nosferatu were a bit too slow and only Head Over Heels managed to be addictive enough to compensate for the lack of speed. Bushido doesn't have the addiction of Head Over Heels (there isn't really enough to the beat 'em up action or enough problem solving), but it is very fast and very playable. Anyone who likes a good arcade adventure should check it out.

● Gordon Houghton

### PREDICTED INTEREST CURVE

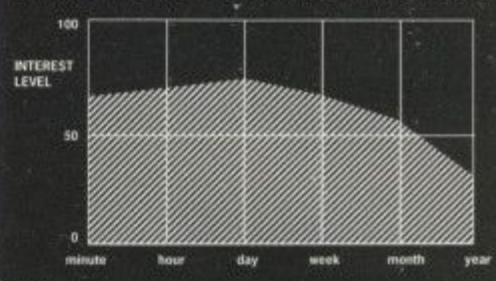

Once you've got used to all the game's different elements, there's enough fighting and searching ahead to keep you hooked.

### RELEASE BOX

C64	£9.99dk	£12.99dk	OUT NOW
No other versions planned.			



The beat 'em up sequences use several different weapons, but more moves would have enhanced an already good arcade adventure.

### C64 VERSION

A pleasant Oriental tune accompanies the equally pleasant (and equally bland) graphics. Everything here is in the gameplay.

GRAPHICS	8	IQ FACTOR	7
AUDIO	7	FUN FACTOR	8
ACE RATING 789			

# GRAPHIC MUSIC SYSTEMS

TEL: 01-231 6018

**Roland**  
NEW PRODUCTS

- **CM-64** SOUND MODULE+ CARD SLOT, MULTI-TIMBRAL £789
- **CM-32L** LA SOUND MODULE £369
- **CM-32P** PCM SOUND MODULE MULTI-TIMBRAL+ CARD SLOT £445
- **CN-20** MIDI-MUSIC ENTRY PAD £129
- **CA-30** INTELLIGENT ARRANGER £315
- **MA-12C** MONITOR SPKR 12W £105

**COMPUTER INTERFACES...**

- **MPU-IMC** MIDI INTERFACE FOR MICRO CHANNEL (MCA) £210
- **LA PC-1** SOUND CARD FOR IBM PC £379
- **MCB-1** IBM MIDI INTERFACE FOR USE WITH LA PC-1 £79
- **MPU-401** MIDI PROCESSING UNIT £219
- **MPU-1PC** MIDI CARD INC MPU-401 FOR IBM PC £255

**SIERRA**  
COMPUTER GAMES

- **KINGS QUEST IV** £34.99
- **SPACE QUEST III** £29.99
- **POLICE QUEST II** £24.99
- **SILPHEED** £29.99
- **LEISURE SUIT LARRY II** £29.99
- **HEROE'S QUEST**
- **THE COLONEL'S BEQUEST**
- **SOCERIAN**

**BLAM!**

**SHAZAM**

WITH YOUR CHEQUE OR P.O. FOR IMMEDIATE DISPATCH OF OUR CM SERIES SOUND MODULE PERIPHERALS & COMPATIBLE SEIRRA GAMES. ALTERNATIVELY...

Write to:- **GRAPHIC MUSIC SYSTEMS**  
53 George Row, London SW16 4UB. (Fax: 01-252 0694)  
inc. your P.C. make & model for full info package F.O.C.

**ONLY £1=**  
incl. p&p.



# RALLY CROSS CHALLENGE

## ANCO versus *Super Sprint*

**I**f you've ever misspent happy hours groping furtively in your pocket for yet more ten pence to shove into the slots at the local arcade, you'll know all about *Super Sprint* and its clones. You'll also know that what singles this particular style of racing game out from the others is that it lets up to four players take part simultaneously. The official *Super Sprint* conversions have only managed the usual two. Now, if you've got the right joystick adaptor, you can ease your throttle and tear up the road in a rubber-burning gang of four. That's if you've got an ST or an Amiga - 8-bit owners are stuck with gruesome twosomes.

As per usual there are four drivers per race with non-human competitors to make up the number. Whoever comes last gets replaced by a computer but if you make it into the top three, you're rewarded with points (4 for a win, 2 for second place and 1 for third). You can use these later on, if you feel like customising your motor.

Each player is given access to a personal monitor screen before the action starts. It's at this point that you get to select your control method; not just from joystick or keyboard but from an additional selection of three different joystick controls. It all hangs on whether you prefer your acceleration automatic or manual (either by pushing the joystick up or pressing the fire button). It's a nice touch, though there's not all that much to choose between them.

You also get to make your choice from a menu of car improvements. These include turbo acceleration, more sensitive steering, improved road holding capabilities, a higher top speed and reduced braking distance as well as increased pit efficiency to reduce pit times. This is also where you'll be able to turn your points into extra equipment in between each race.

The single screen tracks throw up all sorts of obstacles in various combinations of tarmac and dirt: hairpin bends, bridges, railway tracks, roundabouts, fords and chicanes. Hit anything, and your mean machine immediately bursts into flames and is replaced by another one a few yards back. Drive too fast, and you'll skid or spin off the track, wasting valuable seconds. If it should get dark in the middle of a race, your headlights automatically come on.

None of this is breath-takingly new or innovative, but it's a tried and tested formula which has proved extremely addictive in the arcades. It also relies heavily on a user-friendly control method and that's exactly what *Rally Cross Challenge* hasn't got. It's far too easy to crash

for a start. Touch a barrier, nick a chicane or graze the side of a bridge and your engine bursts into flames and puts you temporarily out of the race. After a few laps of exploding around the track this can start to get extremely frustrating, especially as the computer drivers never seem to make the same mistake.

It's all the more disappointing because the excellent graphics, slick presentation and wide variety of courses are a constant reminder of what *Rally Cross* might have been. If it weren't for the control method this would be a top-class racing game. As it stands, it's just too awkward to be anything more than mediocre.

● Kati Hamza

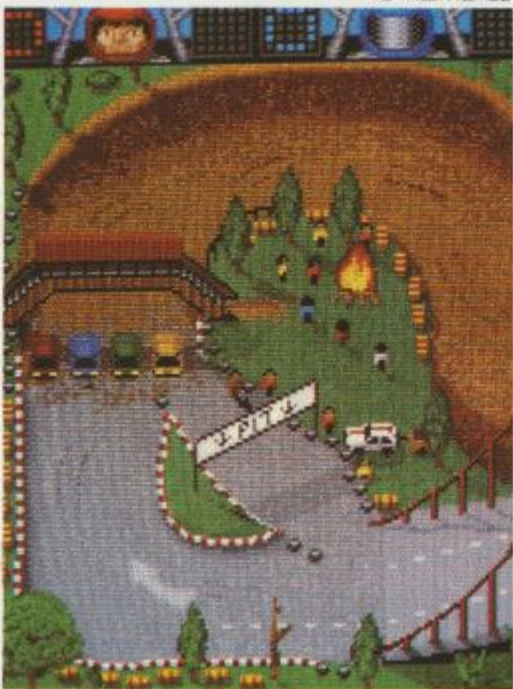

**Rule 2** Anco Rally Cross Handbook: competitors who jump the lights are automatically penalised.



Anco's Rally Cross looks and sounds a lot like *Super Sprint*; pity it doesn't play as well.

RELEASE BOX		
ATARI ST	£19.95dk	IMMINENT
AMIGA	£19.95dk	OUT NOW
SPECTRUM	£9.95cs • £14.95dk	IMMINENT
AMSTRAD	£9.95cs • £14.95dk	IMMINENT
C64/128	£9.95cs • £14.95dk	IMMINENT
PC	£19.95dk	1990

### PREDICTED INTEREST CURVE

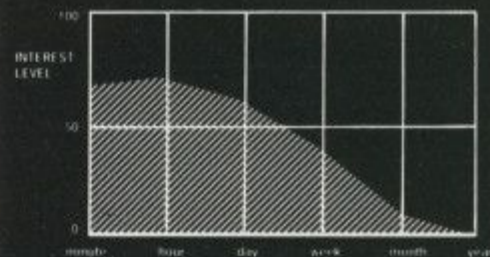

AMIGA  
Nice-looking *Super Sprint* derivative which is marred by poor controls.

### AMIGA VERSION

Despite the control difficulties, the colourful graphics, a wide variety of courses and lots of animated details make this look very attractive; sound is limited to a few droning effects. It's still the best driving game of this type out on the Amiga though, as *Super Sprint* (excellent on the ST) has never been converted for the machine.

GRAPHICS 7 IQ FACTOR 3  
AUDIO 2 FUN FACTOR 6

ACE RATING 657



# FLY LOW, HIT HARD!

NOVEMBER  
AVAILABLE  
ON  
**AMIGA**



'The mix between action and realism is terrific'  
- ACE rated 952 - Advanced Computer Entertainment.

'F-16 Combat Pilot wins hands down'  
- 5 star game - New Computer Express.

'F-16 Combat Pilot pulls out all the stops'  
- game of the month, The Games Machine.

I'm primed for action as my F-16 leaves the runway. This time my mission is to destroy a battalion of tanks. Suddenly, threat warning - interceptors closing fast! I quickly select dogfight mode and arm a Sidewinder. We both fire at the same time - chaff and a high-g turn out manoeuvres his missile. A loud explosion tells me he's not so lucky.

## F-16 COMBAT PILOT



Flying fast and low, I turn my F-16 towards my target. Time to switch on the ground radar and arm the laser-guided Mavericks. I fire six missiles in quick succession, Lantirn automatically locking on to each tank. With flak bursting around me I dive for cover and head for home. Approaching base, I contact the tower and request a talkdown for my night landing.

Another successful mission in Operation Conquest - the ultimate test for any pilot...

**BLACK  
BOX**

  
**Digital Integration**  
The Real World of Simulation

Digital Integration Limited,  
Watchmoor Trade Centre,  
Watchmoor Road, Camberley,  
Surrey GU15 3AU.

ATARI ST, AMIGA, IBM CGA/HERCULES, IBM EGA r.r.p. £24.95. IBM versions available on 5.25" or 3.5" discs.

Order your F-16 Combat Pilot now, simply telephone (0276) 684959  
quoting VISA or ACCESS credit card number, name and address.



# VIRGIN'S SANTA

FREE  
GAMES  
THIS  
WAY

Don't miss out on an extra special stocking this Christmas when Santa be awarding the lucky winners with:

**5 FIRST PRIZES OF**

£1,000 worth of software of your choice, or an Amiga or ST plus £500 worth of software of your choice

**10 SECOND PRIZES OF**

£500 worth of software of your choice

**20 THIRD PRIZES OF**

£250 worth of software of your choice

**1000 RUNNER UP PRIZES TOO!**

Any one of the six Virgin Games arcade classics mentioned earlier.

**MAKE SURE SANTA  
VISITS YOU  
TWICE THIS YEAR!**

**HERE WE GO! ....**

Virgin Games have decided to become a Santa and hand out £30,000 worth of fabulous goodies. All you have to do to gain from Santa's generosity is to buy any three of these games:

**SHINOBI**

**DOUBLE DRAGON II**

**GEMINI WING**

**CONTINENTAL CIRCUS**

**SILKWORM**

**NINJA WARRIORS**

Simply collect three tokens - you'll find one in each game - and send them to Virgin Games. The prize draw will take place on 29th January 1990.

WIN  
£30,000  
WORTH  
OF  
PRIZES



# discover why!

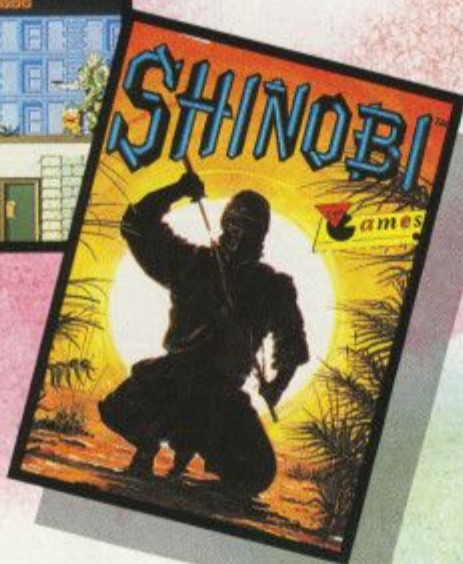

## SHINOBI

You're masashi, a tough ninja warrior on a mission to clear the town from rebel martial arts fanatics. Explore the scrolling urban landscape and beat the hell out of your opponents, but watch out for the end-of-level guardians.



## SILKWORM

It's not true! Even after months of negotiation with the Ruskies and despite a mass exodus out of Afghanistan, we're still under threat. There's no one left to press the Nuke button so the battle has switched to copters and plane. Non-stop shoot-'em-up arcade action.



## CONTINENTAL CIRCUS

Compete in formula one races in Brazil, America, France, Monaco, Germany, Spain and Japan. Race hard, but watch out for other cars. Colliding can be fatal. And do visit the pits for fuel and repairs.

## GEMINI WING

The aliens have had enough. They're not going to take their brethren being blasted on computer screen any more. So they've come down in their hordes to blast the pitiful race of carbon-based life forms called humans. Can you stop them? Somebody has to do it.



## NINJA WARRIORS

Can you survive brutal enemy onslaught? Fight with hand, foot and dagger to rid the street of the scum that dare infest your home town. A classic arcade conversion.



COMING SOON!

## DOUBLE DRAGON II

Ferocious two-player simultaneous martial arts mayhem. Evil fiends have captured your girlfriend - it's up to you and your brother to rescue her. Don't fail. Through the town, countryside, mountains and finally into the lair. Use whatever weapons you can find to stay alive.

### ALL AVAILABLE ON

AMIGA	£19.99
ATARI ST	£19.99
C64 DISK	£14.99
C64 CASS	£9.99
SPECTRUM CASS	£9.99
SPECTRUM +3 DISK	£14.99
AMSTRAD CASS	£9.99
AMSTRAD DISK	£14.99



VIRGIN GAMES  
2-4 VERNON YARD  
119 PORTOBELLO ROAD  
LONDON W11 2DX



As you can see, *Interdictor's* graphics could hardly be described as realistic — they are fast though.

**FLIGHT** simulators have always been amongst the most popular form of computer entertainment and the Archimedes has, at last come of age, with the arrival of *Interdictor*.

Put in control of a high-performance jet, your task is to fly along an enemy valley, destroying gun emplacements, capturing airfields and generally causing as much aggro as possible to the 'other side'.

You start at your own base, armed with a selection of weapons. Rapid cannon fire destroys gun bases, whilst more powerful rockets enable you to blow up anything from enemy barges to bridges. Heat seeking missiles make ideal deterrents when air-to-air combat is the only option left.

As well as weapons, your jet is equipped with all the usual instruments you'd expect on board. A radar and a map allow you to (hopefully) spot enemy aircraft before they spot you,



# INTERDICTOR

CLARES send the Archimedes skyward, but the interest level remains earthbound...

whilst various meters provide information regarding your height and speed. A head-up display (permanently overlaid over the front cockpit view) shows the rate of climb using a scale of pitch bars. These are numbered from 9 to 9 and move up or down depending on your current attitude (or angle!).

Control of the aircraft is provided through the mouse, or by using an optional joystick (available from Voltmace). Sensitivity of control can be anything from sluggish to feather-light. The middle setting gives the best compromise, although it's worth changing to the lightest when accurate control is needed, ie. flying under (and along) bridges. An 'Autostab' instrument acts rather like stabilizers on a bicycle, keeping you level(ish) when control gets out of hand. Very useful.

Now, enough of the theory. How does it fly? Engines on, brakes off and we're away. Pulling the mouse back slightly, raises the nose and the jet lifts off into the blue skies.

One of the main selling points of *Interdictor* is its 'attention to detail', although I would hardly say that the odd 'pyramid' and the occasional rectangle go to make up a 'realistic landscape'. About the best stationary graphics are the bridges. The actual plotting can be a bit haphazard; at one time, the view out of the right window showed two mountains, with the furthest plotted on top of the nearest!

The enemy (aircraft, trucks and barges) are by far the best graphics in the whole game, although it is rare that you'll get close enough to take a decent look. Perhaps if a little more thought had gone into the landscape, the 'real-

istic' label would be justified. Maybe it's meant to be Brazil you're flying over and all the trees have been cut down!

Flying the jet is easy enough and it doesn't take long to master rolls, loops and other acrobatic feats. I can't help feeling it's all a little too easy though. Taking off along the width of the runway and going straight into a vertical climb? I think not. There's no mention of the Harrier in the instructions but who am I to argue? Crashing is realistic though. Hit the ground and you're dead!

Fortunately graphics aren't the only part of a game. This is no Chaplin film and sound makes an appearance wherever possible. Whether it's the roar of the engine as you taxi along the runway, or the thudding explosions as your rockets bring the bridges down, all the sound-effects are excellent. Played through a decent amp, you could almost believe you were there — in the plane, not on the bridge!

To sum up, what could have been an excellent game, is marred by some careless mistakes, and also a general lack of interesting 'things' to do. The whole program goes fast, although this is mainly due to (a) it being run on an Arc, and (b) there isn't much going on anyway!

Unfortunately *Interdictor* isn't a touch on the latest 16-bit simulators (*Bomber* for instance), which is a shame. The Arc is capable of so much more and I hope Clares realise this. Given it's raw power, the Arc could and should out-perform any 16-bit machine available.

(What there is of) *Interdictor* is playable and fun for a few hours. Once you've bombed the bridges and managed to land the jet a few times, there isn't much to hold your interest.

Let's hope the first flight simulator for the Arc isn't the last.

● Rob Miller

RELEASE BOX		
ARCHIE	£34.95dk	OUT NOW
No other versions planned...		

ARCHIMEDES VERSION		
Fast as you'd expect, but the power of the machine could have gone towards handling a more complex scenario rather than simply dishing out speed. Good sound though...		
GRAPHICS	7	IQ FACTOR 3
AUDIO	8	FUN FACTOR 6
ACE RATING 650		

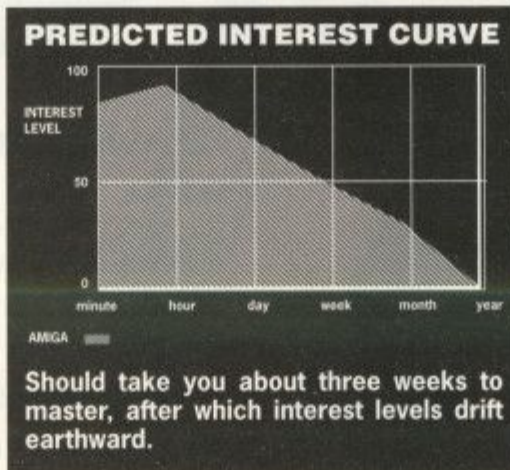



# GO GREEN - GO GREMLIN

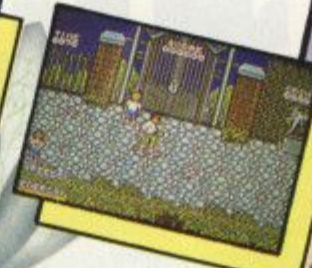

**SKIDZ™**

The most radical game to hit your screen this year. Get on down to the streets and take on the town.  
Available on: ATARI ST & AMIGA.

**MINDBENDER™**

Enter the Magical World of Mindbender. A world full of Mystical Powers beyond all human expectations.  
Available on: ATARI ST, AMIGA & IBM PC.



**AXEL'S MAGIC HAMMER™**

Use the power of Axel's Magic Hammer as you travel eight mystical lands covering 200 screens. Uncover the secret rooms and defend yourself against the many hazards.  
Available on: ATARI ST & AMIGA.

**SWITCH BLADE™**

Hiro, last of the Bladeknights, must reassemble the 16 fragments of the shattered Fireblade. Only then can he take on Havoc and avenge his people's death.  
Available on: ATARI ST & AMIGA.

**OZONE FRIENDLY SOFTWARE**



All mail order enquiries to:-  
Gremlin Graphics Software Ltd.,  
Alpha House, 10 Carver Street,  
Sheffield S1 4FS.  
Tel: (0742) 753423.





# OUT OF THIS WORLD

## TOWER OF BABEL

An intricate 3D strategy game involving an interconnecting network of towers, platforms and lifts all rendered in solid 3D with innovative light and shading techniques. Take control of robot spiders and program them to solve problems and puzzles and interact with other creatures, such as Pushers, Zappers and Grabbers. Alternatively, real time control is available to you at any time for instantaneous reaction to the game's developments. For the more adventurous among you, there is a complete game designer, allowing the construction of your own series of towers, platforms and lifts. Attempt to fox your friends with your own fiendishly difficult creations. More than just a game, more than just a puzzle - Tower of Babel is a whole new concept in strategy gaming.

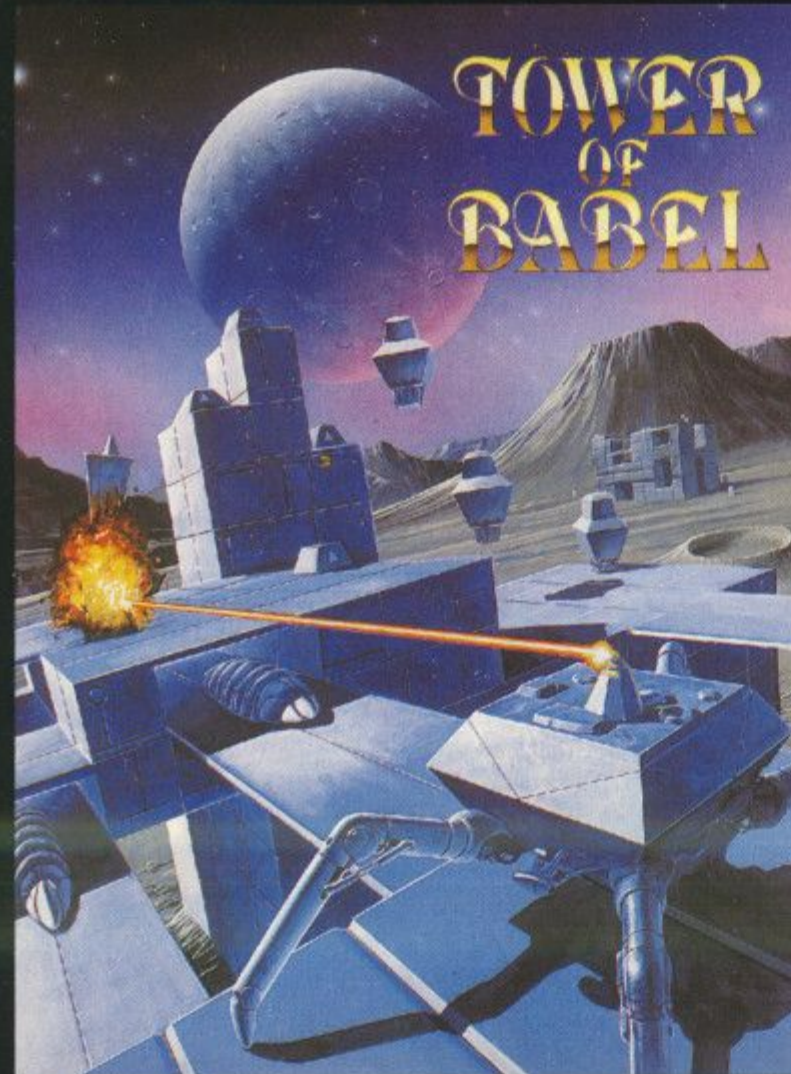
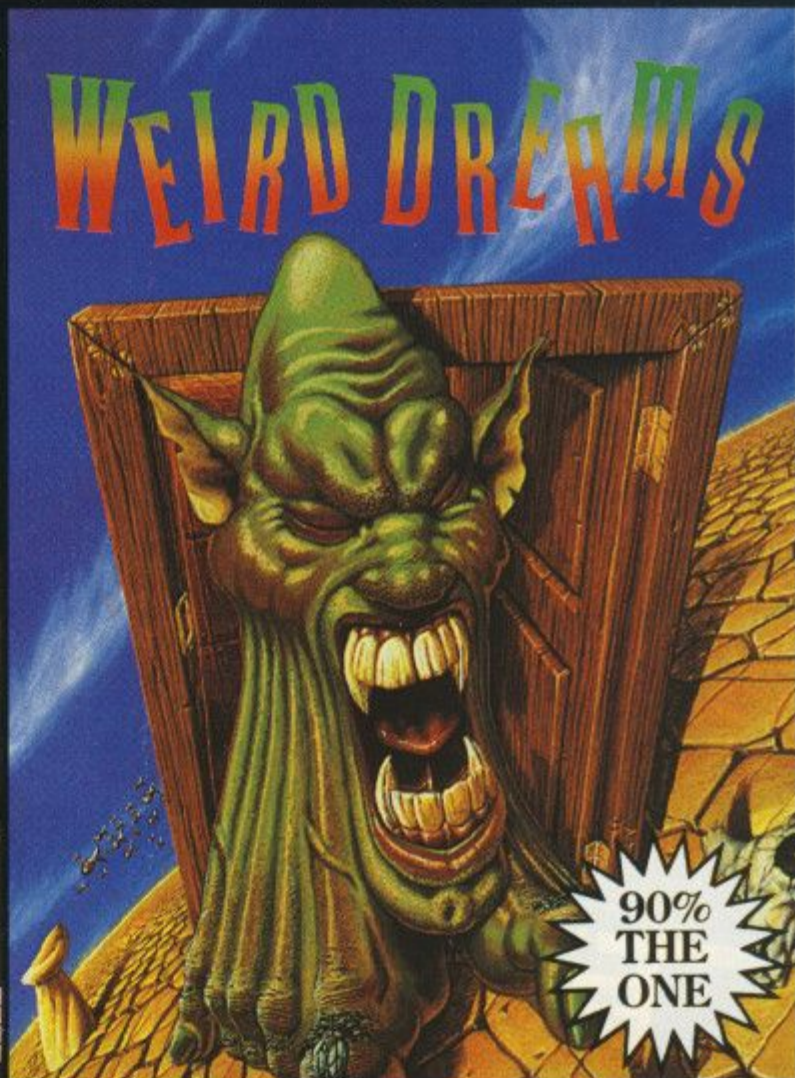
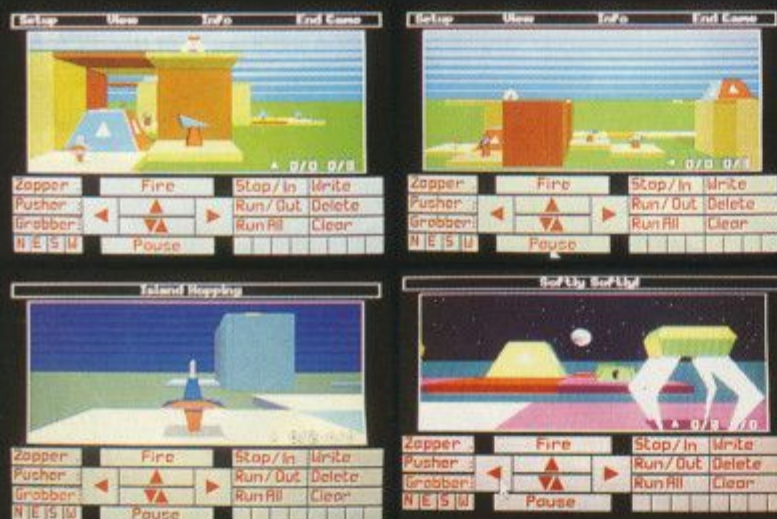

## WEIRD DREAMS

A RIDE ALONG THE ROCKY ROAD OF SUBCONSCIOUS THOUGHT, WITHOUT SHOCK ABSORBERS.

Imagine yourself in a world full of nightmares with Dali-Esque creatures & mind eating eyes. Picture yourself in an upside down landscape Alone in a weird dream & wondering what the . . .

"Weird Dreams is stunning. It's one of the most bizarre concepts yet seen on a computer being more of an experience than a game".

**MASTERS OF STRATEGY  
A DIVISION OF  
MICROPROSE SOFTWARE**

MicroProse, Unit 1, Hampton Road Industrial Estate, Tetbury, Glos, GL8 8DA.



# IT CAME FROM THE DESERT!

CINEMAWARE produce their best game yet: great graphics, great sound, *giant ants*...

**EPIC** ...that's one word you could use when describing the latest – and arguably greatest – game to come over the Atlantic from the Cinemaware Corp, *It Came From the Desert*. Three Amiga discs this time, gulp.

Power up the first disc and BLAMM!! – special effects, sampled music, sampled speech, the works. Not so much a loading screen, more an introductory disc. In 1985 you'd have put up *Defender of the Crown* to impress the neighbours, in 1989 you plug in Disc 1 of *Desert*. But what about the game itself?

Drawing again from movie cliché, this time Cinemaware have captured the 'Bug' movie feeling perfectly (for the original see movies like *Attack of the Killer Tomatoes*). In a delightful send up of a genre – never lapsing into the kind of mud-slinging that would break the spell – the program enters into a conspiracy with the player to believe that he (sexism is part of the cliché, unfortunately) is Geologist Greg Bradley working in the small 50's desert town of Lizard Breath.

You are a relative newcomer to the place, conducting research into the mineral content of meteor fragments, when a particularly unhealthy specimen plonks down just outside the town and – unbeknown to the innocent inhabitants – somehow produces a breed of giant ants that will overrun the town in 15 days. Unless you can intervene for the good guys!

In fact there are two parts to *It Came From the Desert*. First you have to collect enough evidence to convince the local Sheriff that the problem is real and convince him to call out the National Guard. After that....you

direct the forces against the invasion and finally seek out the lair of the ants and destroy the Queen Ant and the nest. No problem, eh?

Cinemaware being the company that it is, the standard of both static and animated

graphics is impeccably high. In the past, the main complaints have been against gameplay – here there is more than enough game and playability in it to satisfy most punters.

The main shell of the game has two elements – your view of static locations, in which you can interact with a particular person shown to be present, via a highlighted response menu plus a scrolling map of the town. Moving the screen pointer to each location will give you its name, plus the amount of time it will take you to get there.

Time is, in the present crisis, clearly of the essence and the game is played realtime, with a second of nowtime accounting for a minute in Lizard Breath.

The attendant arcade sequences are a mixed lot. The one-to-one ant fights (where you have to shoot off the giant antennae, incidentally) are simple, relevant and well implemented. The above view games where you are fighting the ants en-masse are fun and have a direct bearing on the outcome of the game. Whether the same can be said of the knife fight (some of the inhabitants are a trifle violent!) and the 'Chicken' driving game is more open to debate.

However, fail in any of the games and you

find yourself in hospital sentenced to any number of days on a diet of Jello. Attempted escape (so as not to lose time) leads into a hilarious top down game where you try to evade the hapless nursing staff and make it to the main entrance! Piercing sampled screams

of, 'That's Him!' abound to make this game a comic extravaganza!

Taken as a whole, *ICFTD* is probably the best yet from Cinemaware – with special merit going to an atmospheric soundtrack – and any-



EEK! It's ENORMOUS, Sidney!

one who enjoyed previous efforts are certain to enjoy this one.

But the fact that it's a 1 Meg only game and in many ways the gameplay itself, show that the company has probably reached the near limit of what can be achieved using its present design philosophy and technology. Never satisfied with second best, it'll be interesting to see which way they go next.

● John Cook

## RELEASE BOX

ATARI ST	£24.99dk	IMMINENT
AMIGA	£24.99dk	IMMINENT
IBM PC	£24.99dk	OUT NOW

## AMIGA VERSION

As usual Cinemaware do their best to squeeze the utmost out of the machine. No great technical feats, but the highest quality of presentation.

GRAPHICS	9	IQ FACTOR	5
AUDIO	8	FUN FACTOR	7
ACE RATING 895			

## PREDICTED INTEREST CURVE

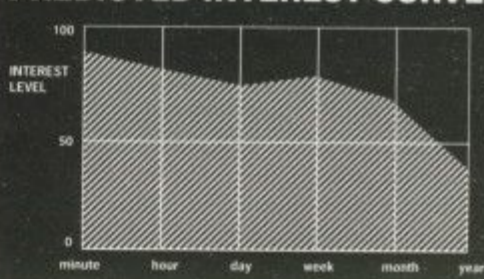

Definitely one to show the neighbours, and enough variety of gameplay to keep you going for quite some time.



Yes, it was worth getting an Amiga, daddy.



# GHOSTBUSTERS

Four years after the block-busting success of GB1 and David Crane's funky computer adaptation, ACTIVISION serves christmas spirit with its turkey...

**SNORTING** cocaine isn't the wisest of pursuits – as actor James Belushi was (so it is rumoured) unfortunate enough to find out. It not only cost him his life but a leading role in one of the biggest grossing comedies of all time.

A staggering box-office revenue of \$220 million has inevitably spawned numerous cash-ins, including two lacklustre cartoon series: The Real Ghostbusters and Slimer! And The Real Ghostbusters plus associated paraphernalia such as action figures keep the tills ringing.

A film sequel was inevitable, but it almost didn't happen. Fortunately the original crew got back together and as a result Ghostbusters II was able to pick up the story. Four years after the team busted the demonic gatekeeper that was terrorising Sigourney Weaver's fridge, paranormal forces return to the city – and when Weaver, now a single mother, notices strange things happening to her baby...who's she gonna call?

The reunited Ghostbusters find themselves doing battle with a river of slime (which grows in response to people's negative emotions) flowing under New York and threatening to engulf the city. The slime's destination is traced to an Art Gallery in the centre of the city, and in it lies an ancient and mysterious painting of an evil wizardly warlord called Vigo.

Activision's computer incarnation of the original film has reputedly sold in excess of 2,000,000 units, which must please its designer, the near-legendary David Crane (who was also responsible for finding those Little Computer People). The task of converting the sequel however was carried out by Foursfield (Incredible Shrinking Sphere and the conversions of Time Scanner).

But whereas Mr Crane chose to exploit the general Ghostbusting theme of the film as opposed to more specific elements like the Marshmallow Man, Foursfield has chosen to exploit specific aspects of the film – three 'key' scenes, interspersed with choice snippets of digitised imagery from the film.

A sampled remix of the original Ghostbusters theme and a neat introductory sequence create a film-like atmosphere before the game proper begins. The first section sees a Ghostbuster-besuited Dan Aykroyd (he wasn't dressed like this in the film) being lowered down a shaft. Spooks attack from all sides (not in the film they didn't), and Dan shoots them with his weapon while swinging from side to side – his main aim is to collect three pieces of a scoop which is used to collect a sample of slime from the river below (well, Dan did have

to collect some slime in the film, but he was already armed with the scoop).

Fast-forwarding through the best part of the movie, Section Two has you in control of the Statue Of Liberty and a crowd of native New Yorkers. The idea is to guide her along the horizontally scrolling street, shooting oncoming ghosts with her torch. The crowd is used to collect the ectoplasm released by dead (!) ghosts while avoiding other ghouls on the floor. Quite where the torch and ghosts came from is anyone's guess...

The final section sees the 'busters inside the Art Gallery in a confrontation with the arch-villain Vigo. Having carefully lowered the four Ghostbusters down a rope into the gallery (but not too fast or they die), your first objective is to dispose of Janosz (Vigo's mortal minion) and rescue the baby to prevent Vigo's power being boosted. But then Vigo steps out of the painting and, via telekenesis, pulls the baby towards him. Quick! Avoid the energy bolts he unleashes and shoot him to win the game.

Control of each Ghostbuster is transferred via a separate screen, complete with digitised mugshots. A twist in the gameplay sees two of them armed with proton guns, and two with slime guns. Janosz has to be shot with the slime, and Vigo (who steps out of painting once the baby is recovered) with the proton.

Apart from the stills and explanatory text, a digitised picture of Vigo is shown following the team's failure, and Janosz is heard to say: "You are like the buzzing of flies to heeem".

And that's your lot. Even more astounding



but true, these three scenes take up three Amiga disks (a staggering FOUR on the ST), and it's a case of musical disks until you turn off. Sadly, Ghostbusters II looks like being one of the biggest turkeys you are likely to see this Christmas. It fails to succeed both as a film conversion and as a game in its own right. Interestingly enough the film was originally going to be called The Last Of The Ghostbusters. After this, I hope it is.

● Brian Nesbitt

## RELEASE BOX

AMIGA	£24.99dk	IMMINENT
ST	£24.99dk	OUT NOW
IBM PC	£29.99dk	IMMINENT
SPEC	£10.99cs	IMMINENT
AMS	£10.99cs £14.99dk	IMMINENT
C64/128	£10.99cs £14.99dk	IMMINENT

## ST, AMIGA VERSIONS

Nice graphics, detailed but not amazingly colourful. Sound is very impressive sampled stuff – the Ghostbusters theme. Both 16-bit versions make equivalent uses of their machine's potential, but early sightings of the 8-bit versions show that it's the gameplay rather than the presentation which really determines the quality – or lack of it.

**GRAPHICS 7 IQ FACTOR 2**  
**AUDIO 0 FUN FACTOR 2**  
**ACE RATING 251**

## PREDICTED INTEREST CURVE

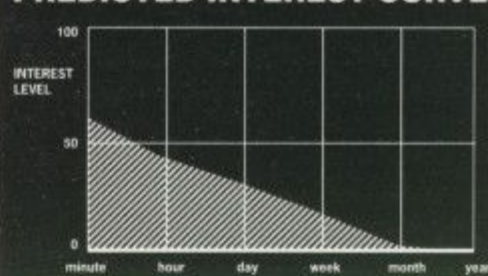

Watch And Wipe software at its best. See the film instead – it's considerably cheaper and much more entertaining.



# NEVERMIND

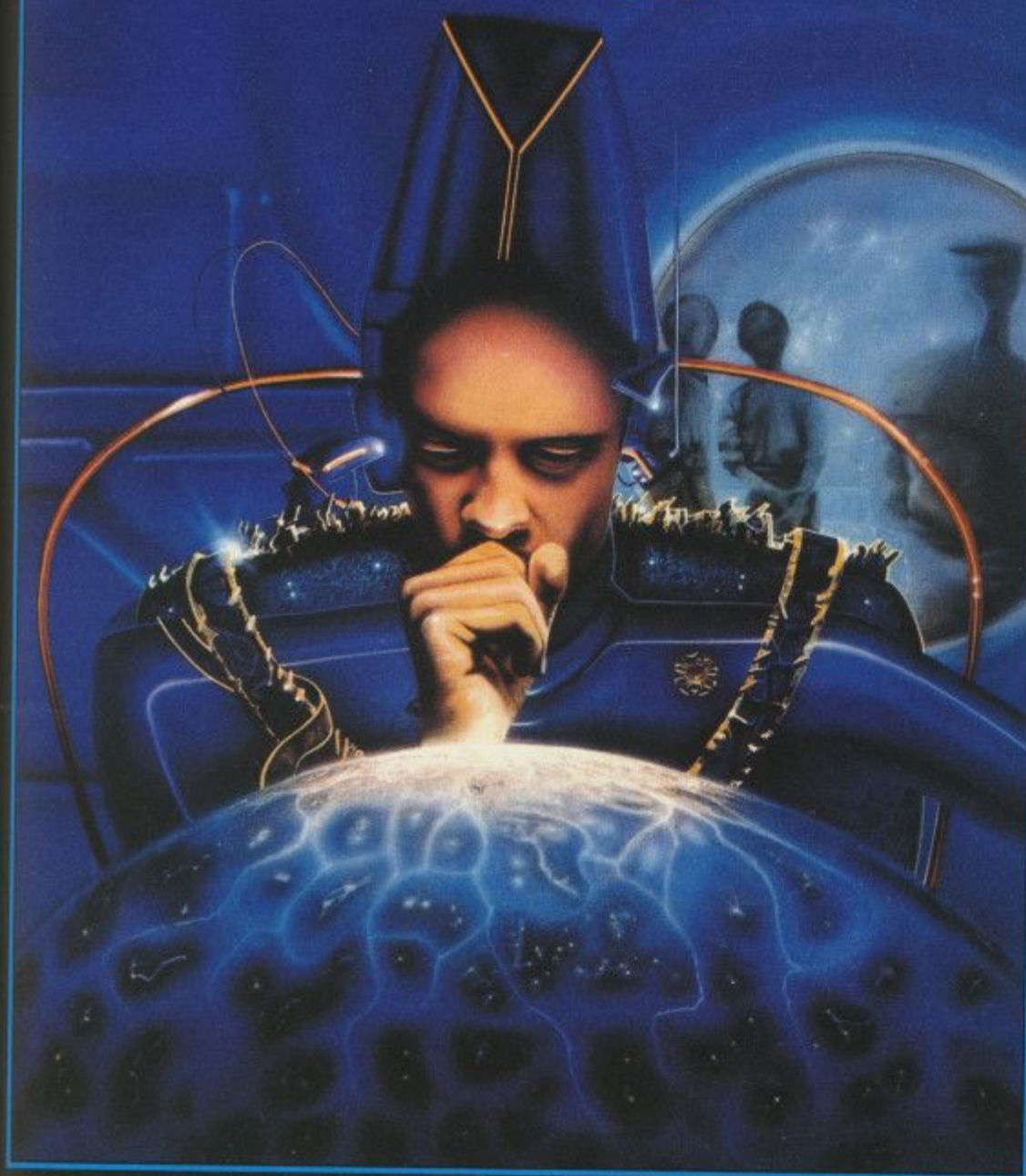

IS YOUR LIFE LACKING A CHALLENGE?  
**NEVER MIND !**  
THE ANSWER TO ALL YOUR PROBLEMS  
(AND THE CAUSE OF SOME NEW ONES)  
**IS HERE**

- ★ STUNNING 3D ISOMETRIC GRAPHICS
- ★ OVER 250 DIFFERENT SCREENS & PUZZLES RANGING FROM THE EASY TO THE MIND BOGGLINGLY DIFFICULT
- ★ INTERACTIVE PLAYScape
- ★ INTELLIGENT OPPOSITION
- ★ CUBIC CHAOS

Never Mind is a unique combination of arcade action and mind numbing problem solving, and uses a clever blend of computer-generated and hand-crafted puzzles. Is your brain up to the most intriguing challenge of the decade? There's only one way to find out . . .

Screen Shots taken from the Amiga and PC Versions

ATARI ST £19.95 AMIGA £19.95 PC £24.95 051-709 5755

**PSYGNOSIS**  
**GAMES PEOPLE PLAY**



# FIRST CONTACT

FIRST CONTACT . . . A MEETING OF SPECIES  
BUT NO MEETING OF MINDS.

Outnumbered, outgunned – human cunning and ingenuity are your only chance!

Mankind is prosperous, unthreatened and therefore militarily weak, yet through technical supremacy has spread throughout the galaxy. The unthinkable has happened – thousands of armed alien vessels pass unchallenged through the occupied quadrants of the galaxy. The first violation has occurred. Alien forces penetrate the station 9W/4 vital to human inter-galactic communication. Your cunning and ingenuity in controlling and programming the maintenance droid on the station is the last hope of mankind.

- Strategic gameplay giving months of enjoyment.
- Fast paced action.
- Superb graphics.
- Immense play area with four decks and entire alien vessel.
- Attention to detail gives total enjoyment.
- Choice of action orientation or deep strategic play.

ANOTHER RAINBIRD CLASSIC



SCREEN SHOTS MAY VARY.

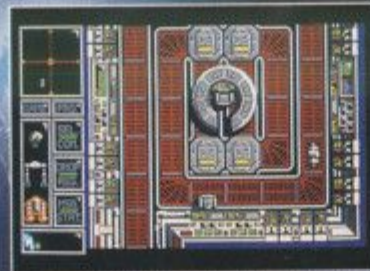
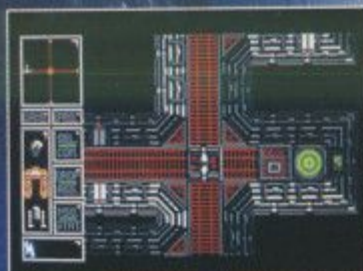

MASTERS OF STRATEGY



# GALAXY FORCE

ACTIVISION convert Sega's eight-legged arcade monster.

**GALAXY** Force was a coin-op for the sea side piers and larger downtown arcades. An eight-legged monster with a hydraulic seat, massive screen, and speakers tucked into every nook and cranny, it was a monster – even by Sega's gargantuan standards.

As is often the case, the deluxe hydraulic version was something of a loss leader for the larger number of uprights that were to follow. Unfortunately for Sega, the game just didn't seem the same without your seat being thrown back as the ship zoomed forwards. After one short summer season *Galaxy Force*, the zenith of bells-and-whistles hydraulic arcade entertainment, had just about disappeared.

Meanwhile, Activision boss Rod Cousens announced that autumn at a press gathering at the London Intercontinental Hotel that his company had signed the rights and would be converting it for home use in Christmas '89. A few mouths dropped open in disbelief. Was this scepticism premature?

The results of this conversion are very far from what most people who have played the coin-op would regard as being a game of *Galaxy Force*. There has to be a point where the experience of playing the home version is so different to the experience of the coin-op that it is reasonable to put the question: are they the same thing at all, and – if not – is it therefore fair that they carry the same name?

The coin-op had amazingly fast, detailed, and colourful graphics with a space ship for you to control that could slow down, speed up and turn through almost 360 degrees. The ST version is slow, has blocky graphics utilising a very limited colour palette, and does not flip through 360 degrees, or anything remotely like it.

The five levels are selected by pulling the joystick to the right bringing into view a cameo view of the terrain on each level. They vary from aerial combat to caverns, trenches and deep space. Apart from blasting anything that is locked onto by your computerised cross-hair, your aim is also to penetrate the enemy fortress and destroy their HQ.

Each of the five levels plays very much like the last one. There are power-ups but these offer little discernible difference to your ship. Shield strength and energy bonuses are registered in your control panel as is a digital display of the time left to complete your mission.

About the best part of the game is when you are inside the fortress and have to swing right and left to avoid crashing into the walls – but this too is let down by poor control of the ship and the inability in certain situations to 'right' your position should you collide with a wall.

What *Galaxy Force* boils down to is a very



3D deep space really shouldn't be as blocky as this.

rudimentary 3D shoot'em up with average graphics and sound. The coin-op relied heavily on the gaspability of the graphic wonders that could be created by its twin 32-bit processors and 16-bit sound processor. The game design was never much to write home about – and without the all singing, all dancing, rockin' rollin' hydraulic cabinet it just ain't the same.

● Eugene Lacey

## RELEASE BOX

ATARI ST	£24.99dk	OUT NOW
AMIGA	£24.99dk	IMMINENT
C64/128	£9.99cs £14.99dk	IMMINENT
SPEC	£9.99cs £14.99dk	IMMINENT
AMS	£9.99cs £14.99dk	IMMINENT

## ST VERSION

Dementia were the development house who put their name to ST *Galaxy Force*. I can't believe it is one of their proudest achievements. The 3D routines just aren't convincing. Its graphics are C64, circa 1985, standard.

GRAPHICS	4	IQ FACTOR	3
AUDIO	4	FUN FACTOR	3
ACE RATING 395			

## PREDICTED INTEREST CURVE

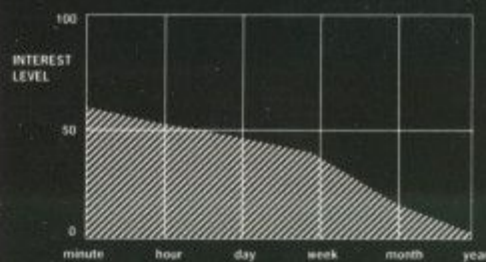

Not exactly in the great tradition of arcade conversions, *Galaxy Force* fails to impress from the start and never recovers.





**ANYBODY** remember Paul Shirley? Well, if your games-playing history doesn't go back beyond a couple of years, it's a good bet you don't. But if you're a seasoned gamer, you're most likely to reply, "The Paul Shirley?" as young Paul was the man behind *Spindizzy*, an upmarket clone of Atari's *Marble Madness*, and one of the true all-time computer classics which, sadly, never made its way onto the 16-bits.

Now, after a two-year absence, Paul has returned with *Quartz*, another brilliant clone – but this time he's not drawn inspiration from any one game, but from every shoot 'em up ever written! *Quartz* traps you inside a huge crystal, with the simple objective of escaping – alive.

Anybody who knows anything about physics will tell you that a crystal is composed of many different layers, and it's these layers that form the basic layout of the game. The

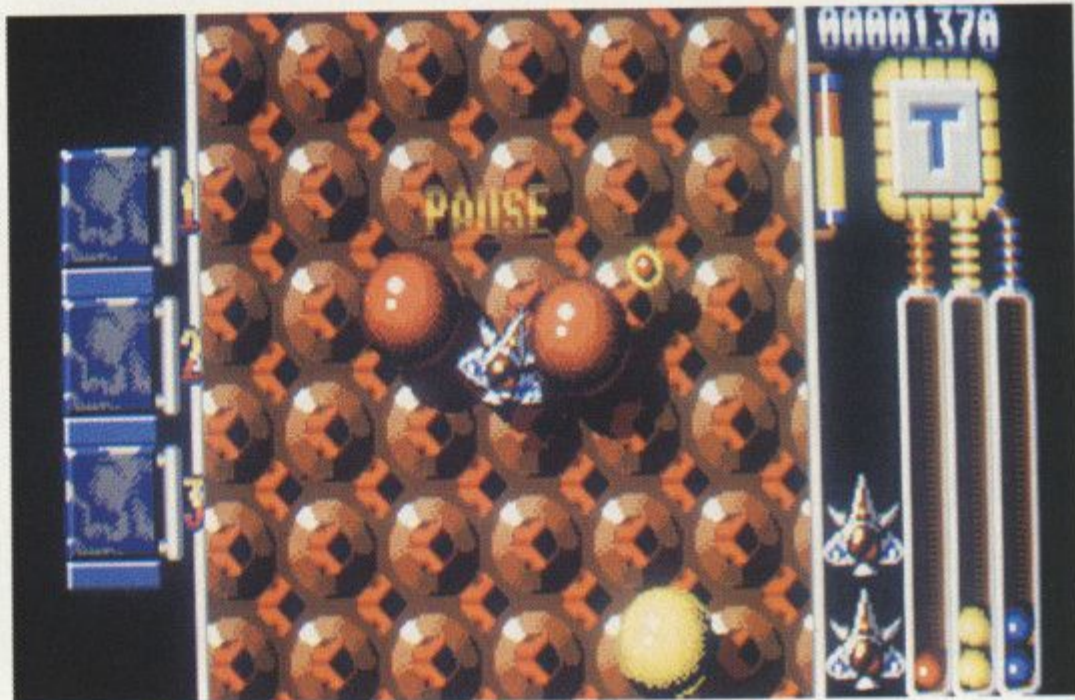

# QUARTZ

lynchpin of the entire game is the Lattice, an eight-way scrolling shoot 'em up set in the core of the crystal and based on the classic *Asteroids*. Here, though, the asteroids are replaced by coloured Hadrons that float around the Lattice. Shooting the Hadrons break them up into smaller Quarks which in turn become collectable Neutrinos when shot. Collect the correct amount of each colour Neutrino, and they can be traded in for a power-up, and this is where the real fun starts.

Your ship is equipped with three empty weapon slots (upgradeable to six), where weapons are placed when purchased. This system allows any combination of the ten weapons to be fitted, so – depending on your playing style – you could have three Octoguns, an Octogun, plus a Bomb and a Flame, or...anything you like. The function keys switch the weapons on and off, allowing you to switch over to the correct weapon for the next section.

RELEASE BOX		
AMIGA	£24.99dk	OUT NOW
ST	£24.99dk	OUT NOW

AMIGA VERSION			
It's business as usual apart from the soundtrack. It's more technically accomplished than the ST's as you would expect with sampled speech, but it's not the same racey tune – it's a more downbeat affair that doesn't work quite as well.			
GRAPHICS	9	IQ FACTOR	4
AUDIO	9	FUN FACTOR	9
<b>ACE RATING 905</b>			

The man behind *Spindizzy* returns with a stunning shoot-em-up for FIREBIRD.

After a minute or so of blasting and collecting, you are dragged off course into one of the four other layers of the crystal. The Atomic Zone is the classic left-to-right scrolling shoot 'em up with a number of novel twists (rotating arms of flame, for example, similar to those in *Super Mario Brothers*) and The Nucleus, an end-of-level baddie that must be destroyed one cell at a time.

The Void scrolls from top-to-bottom. Nothing special there, but the swarms of aliens are accompanied by meteors that come OUT of the screen at out, *Galaxy Force*-style, gun installations, and an even tougher guardian. The Lair scrolls from right-to-left and plays like a mirror image of the Atomic Zone, but is much tougher due to the deadly force fields and electric storms. Finally there's the Organic Zone, a classic bottom-to-top vertical scroller in the *Xenon* mold where everything has an Alien-esque slimey feel – look out for the pulsating brain at the end!

When one of the sections is completed, it's back to another, tougher Lattice, swarming with aliens as well as Hadrons. And so it goes on...

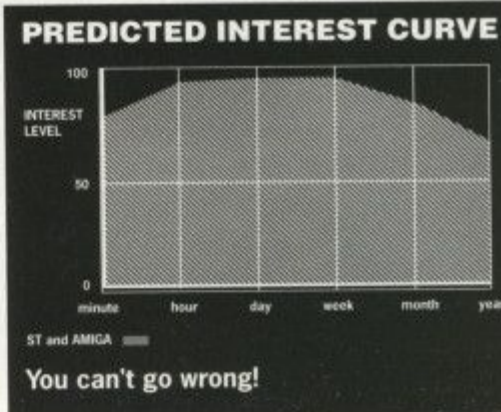

ST VERSION			
The soundtrack is perhaps this version's strongest aspect – fast moving, bouncy and everything else an action game theme should be. Can't wait for the CD Single!			
GRAPHICS	9	IQ FACTOR	4
AUDIO	10	FUN FACTOR	9
<b>ACE RATING 905</b>			

*Quartz* is sheer brilliance – virtually flawless in every aspect. Each of the five separate levels is a respectable game in its own right, but bundled together they make an awesome combination. It's tough...but not so tough as to be frustrating or off-putting. Aesthetically, it's a dream; with Bob Stevenson's top-hole graphics lend a touch of class together with some of the best soundtracks heard on the ST and Amiga to date. *Quartz* is an amazing game seriously rivals *Xenon II* in the shoot 'em up stakes.

● Gary Whitta

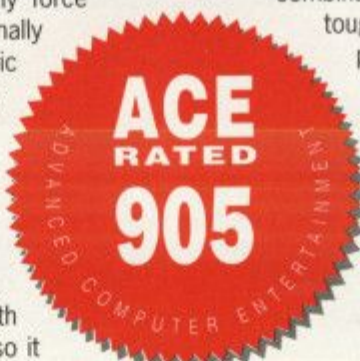



NOW APPEARING ON A  
SCREEN NEAR YOU!

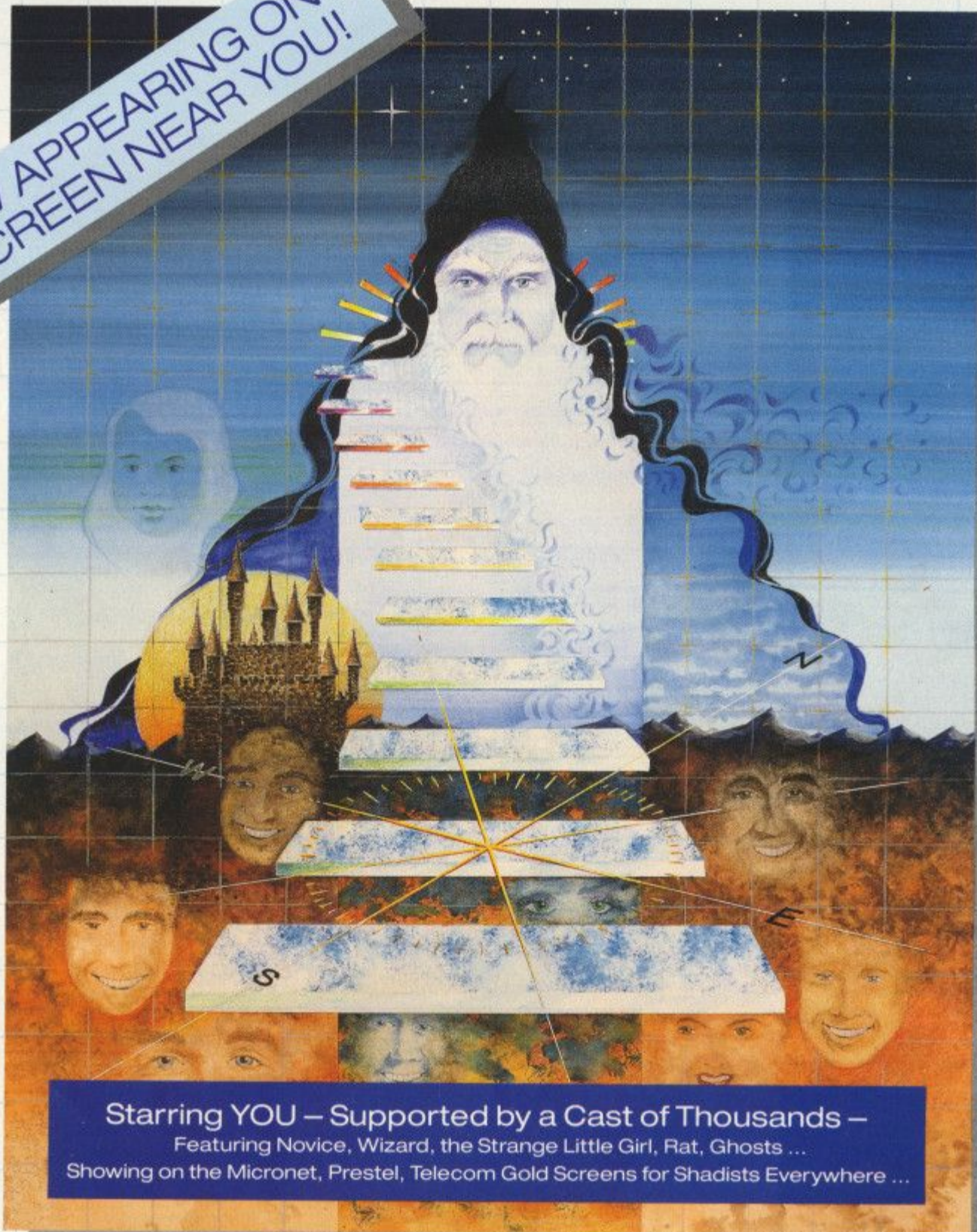

Starring YOU – Supported by a Cast of Thousands –  
Featuring Novice, Wizard, the Strange Little Girl, Rat, Ghosts ...  
Showing on the Micronet, Prestel, Telecom Gold Screens for Shadists Everywhere ...

## SHADES THE ULTIMATE ADVENTURE MULTI-USER GAME...

The game that's unique! Forever changing. Always different. Can YOU outwit the brains of real human opponents rather than a pre-programmed computer chip? Meet people. Make friends. Face and overcome adversity to rise through the ranks and wield power over the land.

But don't be fooled – all may not be as it seems!

SHADES is available to computer owners exclusively on Micronet, Prestel and Telecom Gold. For further information fill in the coupon or phone **free** on **0800 200 700**.

Return to: Dialcom Direct, Shades PO Box 1351, London NW2 7HZ  
NAME \_\_\_\_\_  
ADDRESS \_\_\_\_\_  
MACHINE TYPE \_\_\_\_\_ TEL NO \_\_\_\_\_  
AGE \_\_\_\_\_

**Shades**  
ACE 1



# AFTER THE WAR

## WHAT WOULD REMAIN AFTER A NUCLEAR WAR?

RUBBLE, ASHES, MISERY, DESTRUCTION, ARMED THUGS, POWERFUL CRIMINALS, MAD SCIENTISTS, DEPRAVED MURDERERS... AND A MAN: JUNGLE ROGERS, BOSS OF URBAN JUNGLE. WHEN THERE'S NOTHING ELSE WORTH FIGHTING FOR, YOU HAVE TO FIGHT FOR YOUR LIFE.

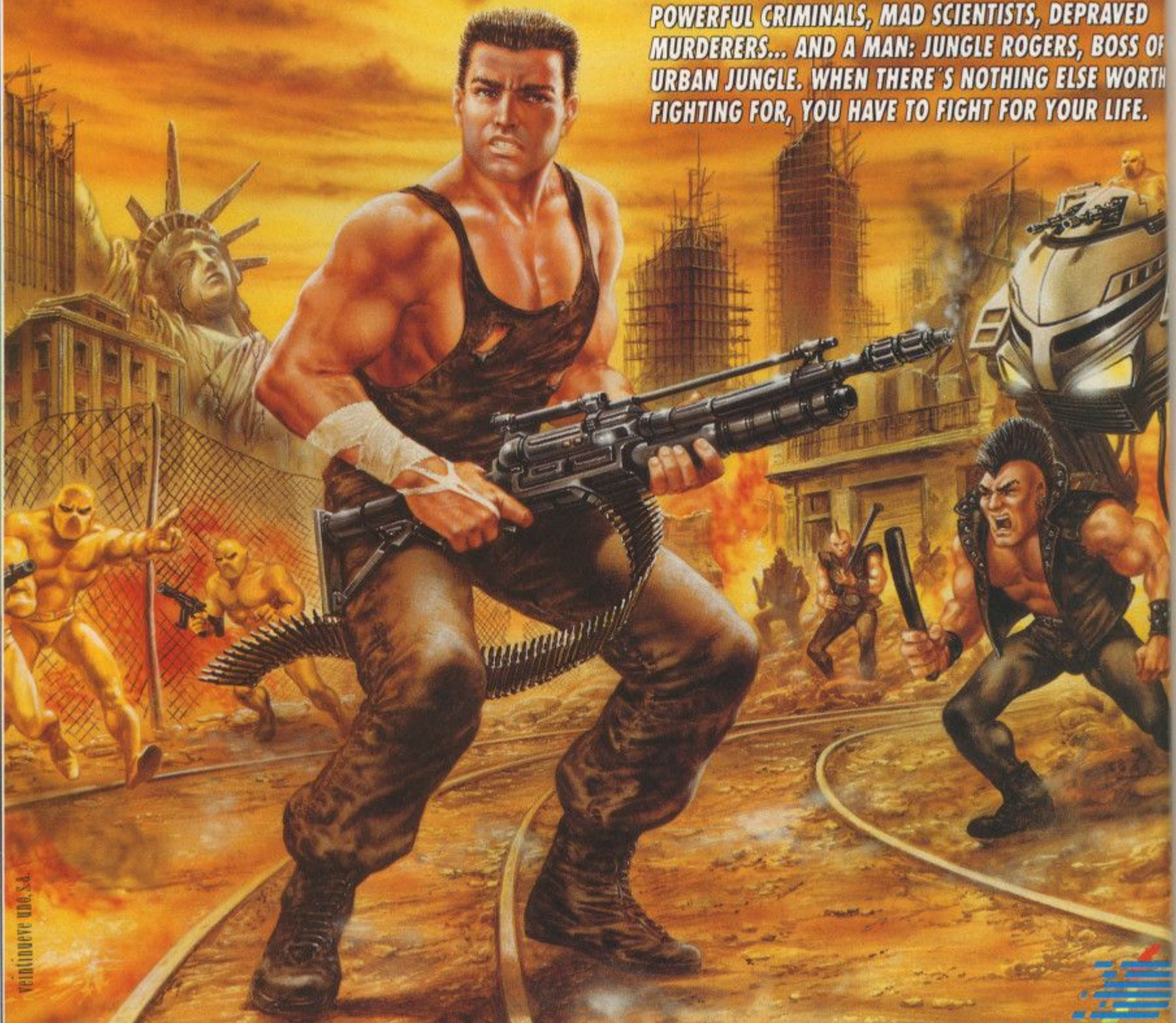

REINQUERE 1986 S.A.

**DINAMIC**

AMIGA, ATARI ST £ 19.95  
SPECTRUM, AMSTRAD, C64 DISK £ 14.95    SPECTRUM, AMSTRAD, C64 CASSETTE £ 9.95

Distributed by **USI**



ATARI ST



ATARI ST



AMSTRAD



SPECTRUM



C64



# DRAKKHEN

RPG Francais from Info-  
games...

**OF** late, the French have started issuing a more than serious threat to the British software market. With the excellent *Future Wars* hitting the shelves over Christmas and now *Drakken*, it looks like 1990's going to be a heady year for the Gallic software tycoons.

*Drakken* is a stylish role play, set in your typical run-of-the-mill fantasy world, bringing together four adventurers to triumph over yet another horde of evil demons. As with most RPG's you have to create your little band from scratch, but you cannot re-roll the dice to change a character's statistics, so it's quite easy to have a varied party. With a choice of fighter, scout, magician or priest you can play the field and have an immense number of abilities at your disposal.

All commands are issued via the mouse and the return key, then through a pleasantly tidy operating system. When the group travels across the land, they move as a unit. Pressing return divides the party into the four members. From there you can send each one on a separate task.

The only problem with moving the group (or a character) to a different location is the time factor; first you select where you want

them to go, then sit back and wait for them to get there, taking all of half a minute at times.

Manipulating on screen objects is achieved by placing the cursor over them then clicking the left button, similar to the system in the Sierra games. There is also a list of commands which are accessible when an individual character is selected, including a useful search facility.

Interactions between computer controlled characters and your team is basic but effective. You're given the choice of greeting, questioning or impressing them. Most of the time any of these will obtain a useful reaction, though on the odd occasion they will attack.

Combat is also executed in a simple, effective manner. merely click the pointer on the creature you wish to maim and the character nearest will strike a blow. Naturally you can expect some fierce retaliation. Spells can be used by the magician and priest and are operated in much the same way as the combat,

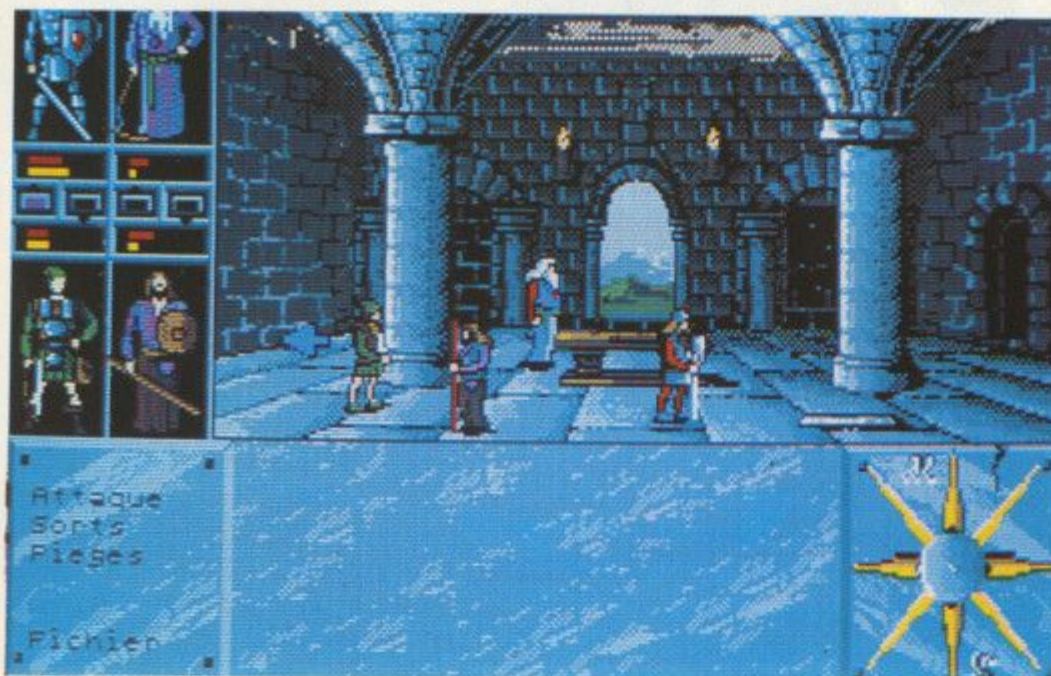

The four adventurers (seen in the status panels to the side of the screen) begin to explore an ancient building. As you can see, *Drakken's* atmospheric 3D graphics are extremely impressive.

select a spell and click where you want to activate it.

As RPG's go *Drakken* is a fine game, though perhaps lacking the depth that makes a classic game. But on the whole a fun, lasting fantasy jaunt.

● Mark Patterson

## RELEASE BOX

ATARI ST	£29.99dk	OUT NOW
AMIGA	£29.99dk	IMMINENT

No other versions planned.

## ST VERSION

The major plus is the speed. Combined with the smooth command system, the game flows very smooth. The graphics are utilitarian, but provide a few nice surprises later on in the game. A worthwhile RPG.

GRAPHICS	8	IQ FACTOR	7
AUDIO	N/A	FUN FACTOR	8
ACE RATING 820			

## PREDICTED INTEREST CURVE

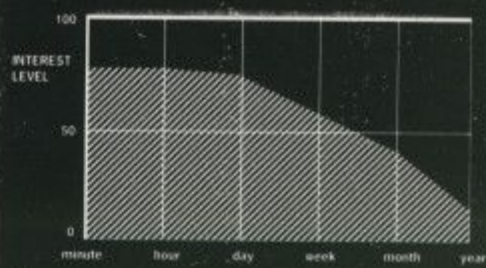

Great fun to get into, and a pleasure to be treated with typical US attention to detail, but in the end the action loses interest.



# Austerlitz

COMING SOON ON ATARI ST, AMIGA & PC



*Get ready to experience the  
Horror and Glory that was the  
battle of Austerlitz!*

The date is the 2nd December 1805. The place is a few miles east of Brunn in the province of Moldavia. Ranged across the barren Pratzen heights are the forces of the Austro-Russian army. Facing them, between Santon Hill and the River Bosenitz is Napoleon's Grand Armée. The greatest battle ever to be fought by France's 'Little Corporal' is about to begin.

Using a unique system developed by Dr. Peter Turcan, AUSTERLITZ gives you the opportunity to relive that battle. The battlefield is represented on your screen in incredible 3D graphics. You can actually observe your troops as they move and fight their way across the terrain.

Your orders are written out for your Corps Commanders, just as they would have been at the actual battle, and then relayed by messenger riders. Of course, orders might be reinterpreted, ignored, or even fail to get to their anticipated destination, and even if they do arrive, it all takes time - exactly the sort of problems faced by Napoleon and the Russian Czar Alexander on that cold winter day.

*Play AUSTERLITZ, and take up the challenge that gives you the chance to rewrite the history books!*

Written and designed by Dr Peter Turcan. Illustration by Peter Curzon.



© 1989 MIRRORSOFT LTD.



# THE CYCLES

ACCOLADE put the PC on two wheels and give you 15 tracks to choose from.

**EXACTLY** what kind of bizarre chimera you'd get if you fused a stereotyped biker with the average PC user must stretch even the most vivid of imaginations. I can envisage the scene now.

Dressed in full M&S rig – with tassles – he approaches the machine. Nonchalantly mounting the swivel chair, he whips off the studded leather dust cover (IBM Rools) and powers up the International Bonneville Machines 45 MHz 386 with an 80 Meg hard disc.

The internal drive grows into life as the whole kit surges power into the customised monitor. As the C prompt bursts onto the screen he sends the mouse screaming across the desk into a full blown wheelie and taking the first double click blindingly fast, brings up.....well....*The Cycles* probably.

Published by US firm Accolade, programmed by the Canadian mob at DSI, *The Cycles* is very much a transatlantic product aimed at the recreational PC user and attempts to capture the thrills, spills, hills, and chills of international Grand Prix motor cycle racing. And it's nothing if not comprehensive.

As you come to expect from US software, there are options galore before you even set foot on the tarmac. Take a practice lap, a single race, or go for the big one – a full season of 15 races, each round a different track. Choose a difficulty level – there are five in all from easy-peasy auto gear change, undamagable bike and boy scout opposition to full manual, full realism on a track full of Hells Angels.

Choose name, number of laps per race, then go on to choose your weapon – 125cc, 250cc or the big mutha – 500cc racing beast. Four cylinders, six gears, 165mph at full wack. Ouch! So on to the race itself.

Selecting one track from 15 international venues (the Brit track is Donnington Park, not Silverstone – boo!) you find your view is a classic 'over the handlebars' job, rather than the behind the bike view of, say, *Hang On* or *Honda RVF*. First thing – you take one lap to qualify for a place on the grid. Vroom!

Using joystick or keyboard, the controls are simple enough – faster/slower, left/right,

change up or change down – and quite responsive. Particularly good news for non-standard joystick owners is that you calibrate your stick before the race.

Zooming off the grid at high speed (on the higher difficulty this levels results in spectacular wheelies) you have the track to yourself and there's no denying that it's fun. Going into a turn does not tilt the horizon – that stays level the whole time – but the handlebars turn in, and the right clutch hand animates when you change gear.

Another neat touch is the way that track gradients have been handled, with quite realistic dips and hills to encounter – certainly the best I've ever seen on a PC to date.

Finish the lap, get a grid position and the real thing starts – against nine other guys. Some drive pretty damn fast and all seem to get in the way just when you'd rather they didn't. All ex-bike messengers probably.

The whole event is undoubtedly a good laugh and if you want to take on a whole season the program even allows you to save position and come back to complete the marathon another time. But does *The Cycles* ever manage to make you suspend your belief that you are ever doing anything other than playing a computer game? Unfortunately not.

Partly it's the hardware limitations of the PC. Most of us will have to put up with Spectrum-standard sound – although those with Tandy sound or Ad Lib boards will do much better. The graphics can't be to blame – EGA is fine and CGA is, well, adequate

yucky CGA.

Probably I'd pinpoint lack of speed as the major factor. It's not that *Cycles* is slow, far from it, but it doesn't seem to deliver quite fast enough to convey that extra bit of realism the hardened computer biker will hunger for. Makes you wonder how much of an overhead that very nicely implemented, but largely unused, rear view window takes up?



Heading up to the finish (with most of the other competitors ahead of you unfortunately) in glorious 3D on the PC.

However, *The Cycles* still comes well into the category of 'quality product' and as long as your expectations are not unrealistic will not disappoint if you're looking for a fun race game with enough options to make sure you'll be playing it for more than the customary couple of weeks. Yet another reason to consider buying a sound board, too!

● John Cook

## RELEASE BOX

ATARI ST	£24.99dk	IMMINENT
AMIGA	£24.99dk	IMMINENT
IBM PC	£24.99dk	OUT NOW

## PC VERSION

The sound rating given is for the unexpanded PC. Otherwise the game makes good use of the world's fastest growing games machine.

GRAPHICS	8	IQ FACTOR	2
AUDIO	2	FUN FACTOR	7
ACE RATING 773			

## PREDICTED INTEREST CURVE

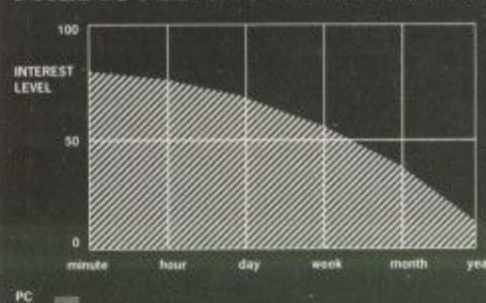

Great fun to get into, and a pleasure to be treated with typical US attention to detail, but in the end the action loses interest.





# In 1989 the Wall cracked... ...in 1948 a nation cracked.

As a nation is torn apart in one of the greatest political tragedies in modern history, this is only but a backdrop for a far more sinister event that has taken place. An atomic bomb is found missing from a British base and is believed to be headed to the Soviet forces. As a lone American agent, you must scour the city questioning the military police and occupying forces and interrogating the shadowy figures of the underworld, in your mission to recover the bomb before the Cold War takes a much more dramatic twist.

REAL TIME ACTION • BIRD'S-EYE-VIEW • PERSON TO PERSON COMMUNICATION • HIDE AND FOLLOW ROUTINES • MOVIE LIKE ANIMATION.

Amiga, Atari ST,  
IBM PC  
- £24.99

INCLUDES  
A UNIQUE  
SYNCHRONISED AUDIO  
VISUAL HISTORY OF THE  
EVENTS LEADING UP TO  
THE COLD WAR

FREE

YOU ARE LEAVING  
THE AMERICAN SECTOR.  
ВЫ ВЫЕЗЖАЕТЕ ИЗ  
АМЕРИКАНСКОГО СЕКТОРА.  
VOUS SORTEZ  
DU SECTEUR AMERICAIN.  
YOU ARE ENTERING THE  
SOVIET ZONE

Achtung!  
Sie verlassen  
mich.  
West-Berlin  
Zone

EAST vs WEST BERLIN 1948

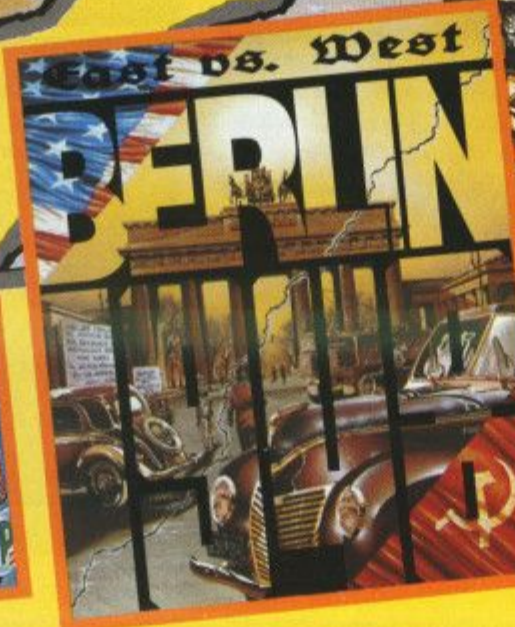

Screen shots from Amiga version.

**TIME WARP** **Rainbow Arts** A Time Warp production for Rainbow Arts



# SNARE

THALAMUS ensnare late night game addicts with their newest puzzler

**QUEDEX** remember that? Well, unless you're a C64 owner who enjoys puzzle type games you probably won't. The idea behind the game (which incidentally gained an ACE Rating of 934 in our very first issue) was that you controlled a ball rolling across a series of planes. The aim was to exit each plane in the quickest possible time, but in order to do this you had to solve some very tricky problems first. The resulting game was addictive enough to keep even the most somnolent person playing all night.

Thalamus' latest puzzler, *Snare*, is very much in the same vein. This time, rather than a ball, you control a small spacecraft which glides over a platform. Using the joystick you can control the craft's speed and direction, as well as making it fire and jump. Turning is a little confusing at first because the whole screen suddenly flips through 90°. Until you become accustomed to this it can be very disorientating, especially if you make several turns in quick succession. Eventually you think nothing of it, but it is still quite confusing watching somebody else play.

Mastering jumping is absolutely essential, because there are many occasions on which you have to leap chasms between platforms. It's not just a case of moving to the edge of the platform and leaping either. You have to carefully gauge your speed on the approach. Get it too slow and you won't make the distance and consequently end up plummeting to a very sticky end. Approach too quickly and you'll probably overshoot and smash into a wall on the opposite platform.

Again the idea behind this game is to find the transporter that allows you to exit each level. Occasionally a level will be divided into several sections, each of which is linked by a further transporter pad.

Solving each level is not quite as simple as

gliding about until you find the exit however. Firstly, each level is divided up into corridors by walls. Hit one of these and you're a gonna. Secondly there are a number of special tiles strategically placed on each level. Each of these has a different effect on your craft if you pass over them. The effects vary from minor inconveniences (like preventing you from turning) to disasters (sending you hurtling forward at full speed towards a nearby wall for instance).

Each of the different types of tile is colour coded, but it is all too easy to forget which does what. This is the one small gripe I have — it would have been better if each tile had a completely different design rather than just being a different colour. The problem is not enough to spoil the game however.

Another problem you have to face are the alien ships which patrol each level. These keep to set routes rather than attacking you directly. Contact, however, is still deadly. It will do you no good whatsoever to simply blast every alien ship you come across (some of them are indestructible anyway). Many of them are essential to the completion of the level. In some cases you must redirect the alien by building new walls to force the enemy ship to lay new tiles for you.

There are also switches which affect some part of the platform you are currently on. Unfortunately they can also be activated by the aliens. It is most distressing when you are about to cross a bridge which has been erected by throwing a switch, to find it suddenly disappear because some inconsiderate alien ship has run over the same switch.

The first few levels of *Snare* are not that taxing, but you will soon find that quite a bit of lateral thinking is required if you are to progress. The arcade style aspect should not be quickly forgotten either. At times you need a pretty dextrous joystick technique to overcome some of the devious obstacles the programmer has put in your way.

if you don't like games that require too



At last! A transporter, but watch out for the alien craft.

much thinking then I can't really recommend this to you. On the other hand, if, like me, you enjoy putting the old grey matter into play from time to time then this is just your cup of tea. Go ahead and try it — you'll find it frustrating, but I guarantee you'll be back time and time again until you complete it.

● Laurence Scotford

## RELEASE BOX

C64/128 £9.99cs £12.99dk OUT NOW

No other versions planned.

## C64 VERSION

The graphics are really not all that hot. In fact I'd go as far as to say that they are functional. There could have been improvements here, but fortunately the game is not spoiled too much by this inadequacy. The sound is generally good, and not too obtrusive (important when you're trying to think on your feet). On the whole *Snare* on the 64 is an enjoyable and very addictive game.

GRAPHICS 5 IQ FACTOR 9

AUDIO 7 FUN FACTOR 8

ACE RATING 825

## PREDICTED INTEREST CURVE

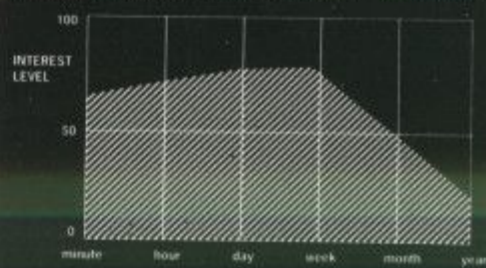

It will probably have most appeal once you've solved a few levels. If you manage to solve it you are unlikely to go back to it again.



The switch in the corner turns on a useful bridge. The alien turns it off again.



# CLOWN-O-MANIA

STARBYTE clown about with manic 3D platform fun

**MATTHEW** Smith's well-known and ancient debut, *Manic Miner*, was one of those rare games in which simplicity was the key to success. It featured small, but cute sprites, an uninvolved scenario, and straightforward two-dimensional play-screens. It doesn't exactly sound like a recipe for an inspiring game does it?

The game was a runaway success. Highly playable and extremely addictive, it set a precedent for games to come and – together with other classic titles like *Boulderdash* and *PacMan* – helped establish the golden rule that large colourful graphics, megabytes of digitised sound, and highly complicated gameplay are not prerequisites of a great game.

Top marks, therefore, to Starbyte for rejecting current trends towards highly complex scenarios and producing a game which has many of the qualities of *Manic Miner*, and combines them with another great classic in the same vein – *Pacman* – bringing both concepts up to date.

In *Clown-O-Mania* you play Beppo, a circus clown. One day he discovers a map showing the way to a 'land of many crystals', and decides to give up clowning for ever to go in search of them. Simple, eh?

The actual land Beppo finds is made up of a series of three-dimensional platforms on which are arrayed small round crystals (worth a measly 1 point each) and more exotic angular crystals (worth a handsome 10 points each). These Beppo must collect in *PacMan* style as quickly as possible. There are also roving nasties of varying shape, colour, and deadliness to contend with.

Movement is achieved using the joystick (which actually takes a little getting used to because of the angle of the platforms). To get between levels Beppo must use little yellow ladders. Occasionally there are funnels which he can fall into to descend to a much lower platform or Trampolines and Volcanoes which can be used to reach higher ones. The only other means of transport over large distances are beamers. These are little square teleport pads which can more often than not prove to be extremely frustrating.

Just in case you think that all you are getting here is a souped up 3D *Pacman* variant, I ought to say at this juncture that there is plenty of thinking involved as well, especially on later levels. For example, you will discover squares which change colour as you walk over them. If you manage to complete the level leaving all of the squares the same colour you will earn a massive 10,000 point bonus. That's not as easy as it sounds. As the levels become harder you will frequently find that you 'paint yourself into a corner' as it were, and have to undo all your careful work to get yourself out again.



Clown-o-mania: reestablishing the art of the simple game?

As if colouring squares wasn't enough, you will also have to master the use of pyramids. These come in two forms. Blue pyramids, when dropped, become obstacles which prevent the movement of any nasties that try to cross them, so you can use them to fence monsters in. White pyramids, on the other hand, will destroy any creatures that come into contact with them.

There are many goodies to be had to help you on your way: Clown masks will give you extra lives; Razor Blades can be collected and fired at the nasties; and Jumps can be collected which allow you to leap over gaps. The latter two shoot round the screen at a rapid rate, so collecting them is not that easy.

Once you get further into *Clown-O-Mania* you will also begin to encounter other interesting features like one-way tiles, speed-up tiles and other similar items, all of which must be taken into account as you plan your completion of each level. You will find that you whizz through the first few levels quite quickly, but don't worry – there are seventy of them and they get tricky very quickly.

If you enjoy puzzles combined with fast action then *Clown-O-Mania* is most certainly recommended. It's very easy to get into, but should still provide a long-lasting challenge. Smooth multi-directional scrolling, colourful, well-animated sprites, and pleasant background ditties all go to make up a very polished and entertaining game.

● Laurence Scotford

## AMIGA VERSION

A very competent looking game. It isn't exactly straining this machine, but it plays well. Good use is made of a set of scrolling horizontal and vertical bars in the background to give a sense of great depth. Nice toons too.

GRAPHICS	8	IQ FACTOR	7
AUDIO	7	FUN FACTOR	8
<b>ACE RATING 805</b>			

## RELEASE BOX

AMIGA	£19.99 dk	OUT NOW
ST	£19.99 dk	IMMINENT

## PREDICTED INTEREST CURVE

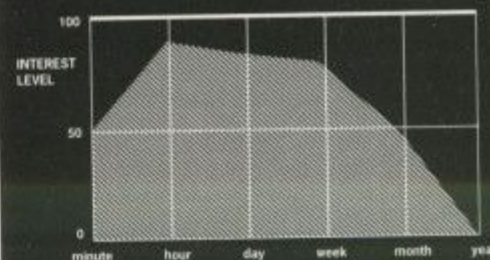

Quite a challenge, but once you've solved it you are unlikely to come back for more.



ATARI...THE POWER BEHIND

# ARC

REACH OUT FOR THE POWER

## THE POWER OF LIFE & DEATH

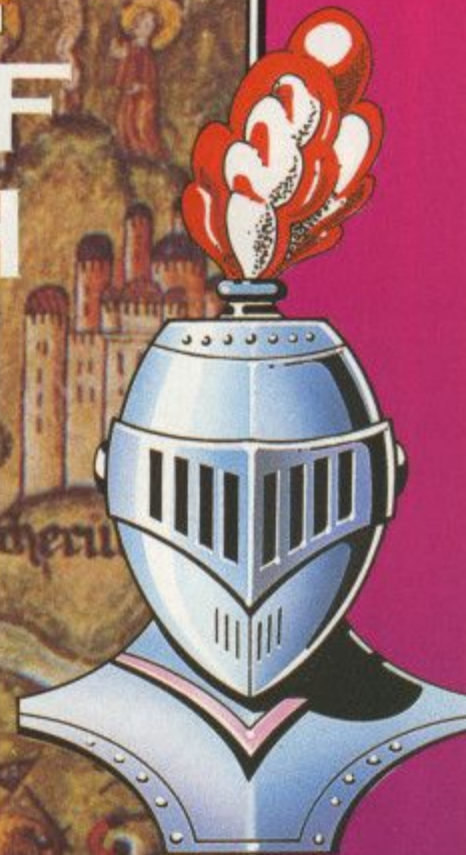

### PRINCE

An uneasy calm besets this picturesque 10th century island principality. Decades of warring have created a stalemate between its two leading princes. Each controls approximately equal territories, towns, villages, subjects and armies but each is possessed by a burning ambition for autonomous rule. Take on this princely challenge, lead your armies forward in bloody conflict and towards ultimate victory.

- Zoom In Zoom Out strategy magnification.
- Eight individual island terrains.
- Animated battle graphics and sounds.
- Two player link up: to Atari St · to Amiga · to IBM PC.

**ATARI ST · AMIGA · IBM PC — £24.95.**

Screen shots from various systems.

REACH OUT FOR THE POWER OF ARC  
ATARI ST · CBM AMIGA · IBM P.C.

ARC, P.O. Box 555, Slough SL2 5BZ.



# OUR STAR DEALS

U.S. GOLD THE LEADING NAME IN SOFTWARE BRINGS YOU A SELECTION OF THE VERY BEST COMPUTER ENTERTAINMENT AVAILABLE ....



**MOONWALKER™**  
 After conquering the world of pop music, Michael Jackson channelled his energy and talent into making his first film. Now U.S. Gold present the home computer version of that film, endorsed by the Superstar himself. Feel the rhythm in Club 30, transform into a futuristic silver robot and ultimately beat the drug peddling MR BIG in the unique world of MOONWALKER - a game like no other.  
 CBM 64/128 Cassette & Disk • SPECTRUM Cassette  
 AMSTRAD Cassette & Disk • ATARI ST • AMIGA • IBM PC



**TURBO OUT RUN™**  
 Driving's biggest game ever just got BIGGER! Turbo Out Run takes you on a 4 stage race across America. Along the way you'll battle bumper to bumper with good guys and bad guys, police cars, porches, blown engines and fickle girlfriends. Drive day-time and night-time, choose manual or auto gearbox, even customise your Ferrari F40 with High Grip Tyres, but whatever else you do ... Use the Turbo booster sparingly - THIS BABY'S HOT AND RARING TO GO!  
 CBM 64/128 Cassette & Disk • SPECTRUM Cassette  
 AMSTRAD Cassette & Disk • ATARI ST • AMIGA

**WINNERS™**  
 A compilation to beat all compilations! Includes Indiana Jones and the Temple of Doom™ • Impossible Mission II™ • Blasteroids™ • L.E.D. Storm™ • Thunderblade™ - the greatest names with the greatest games together in one mind-blowing compilation so you can see why we've called it WINNERS!  
 CBM Cassette & Disk • SPECTRUM Cassette & Disk  
 AMSTRAD Cassette & Disk • AMIGA & ATARI ST  
 (excluding Temple of Doom)

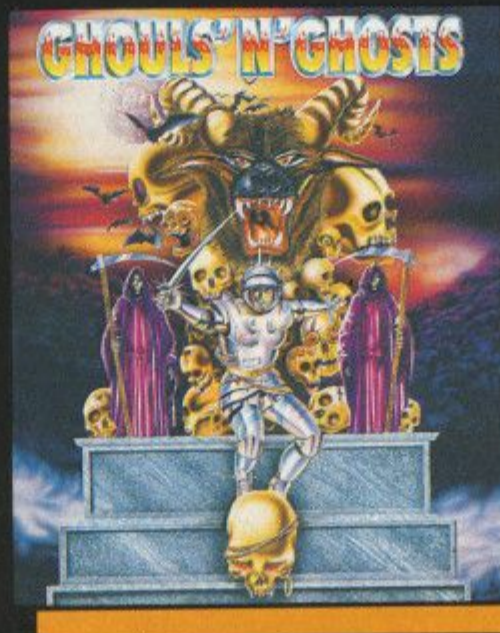

**GHOULS 'N' GHOSTS™**  
 Arthur returns! The fearless knight is back in this stunning sequel to Ghosts 'n' Goblins (voted among the top 10 games of 1986). Three years have passed since the evil ones came to do their dirty work. Now they're back and they've captured Princess Hus, but our valiant knight Arthur is charging to the rescue against a formidable array of gruesome enemies and hairy hazards.  
 CBM 64/128 Cassette & Disk • SPECTRUM Cassette • AMSTRAD Cassette & Disk • ATARI ST • AMIGA

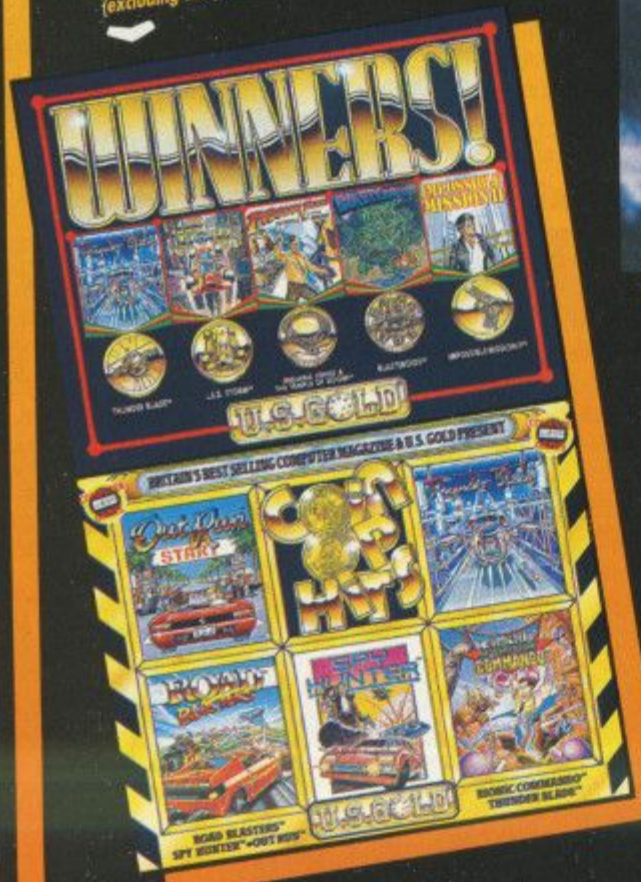

**COIN-OP HITS™**  
 C & V.G., the U.K.'s Best Selling Computer Magazine and U.S. Gold are proud to present a compilation of FIVE ARCADE GREATS! Includes Out Run, Road Blasters, Spy Hunter, Thunderblade and Bionic Commando - all arcade sensations in their own right. Why pay to play every time when you can enjoy the best in arcade entertainment in your own home!  
 CBM 64/128 Cassette & Disk • SPECTRUM Cassette & Disk  
 AMSTRAD Cassette & Disk

**DRAGONS OF FLAME™**  
 Takhisis, Queen of Darkness, and her Draconian hordes have over-run much of the homeland of Krynn. Even the elven armies of Qualinost, valiant in their resistance of this evil power, struggle on the edge of defeat. Heroes of the Lance come forward!... or Krynn will forever be consumed by evil.  
 CBM 64/128 Cassette & Disk  
 AMSTRAD Cassette & Disk • SPECTRUM Cassette  
 ATARI ST • AMIGA • IBM PC





# YOUR STAR DEALERS

FOR THE ULTIMATE IN HOME ENTERTAINMENT CHECK OUT YOUR LOCAL STAR DEALERS ... THERE'S ONE NEAR YOU!

## AVON

- Ace Computers 42 Cannon Street, Badminton, Bristol. Tel: 0272 637981
- Ace Computers 3 North Street, Bristol. Tel: 0272 666341
- Virgin Games 18 Merchant Street, Bristol. Tel: 0272 294779
- Model Shop 8 Fairfax Street, Bristol, Avon. Tel: 0272 273744

## BEDFORDSHIRE

- Dawling Computers 3 Harper Centre, Lower Floor, Harper St, Bedford. Tel: 0234 273090

- Software Plus Unit 11, The Boulevards, Harper Centre, Bedford. Tel: 0234 66598

## BUCKINGHAMSHIRE

- Aylesbury Computer Centre 38 Kingsbury Square, Aylesbury. Tel: 0296 89480

## CAMBRIDGESHIRE

- Software Plus 43 Burleigh Street, Cambridge. Tel: 0223 353643

## CHESHIRE

- Tim's Megastore 29/31 Sunderland Street, Macclesfield, Cheshire. Tel: 0625 34118

## CLEVELAND

- C.H.I.P.S. Computer Shop 151 Linthorpe Road, Middlesbrough. Tel: 0642 219139

- C.H.I.P.S. Computer Shop Silver Court Shopping Centre, Silver Street, Stockton on Tees. Tel: 0642 618254

- Computer Shop 14 West Row, Stockton on Tees. Tel: 0642 606166

- Topsoft 3 Hambledonian Yard, Stockton on Tees. Tel: 0642 670503

## CORNWALL

- Truro Micro Ltd, Bridge House, New Bridge Street, Truro, Cornwall TR1 2AA. Tel: 0872 40043

## COUNTY DURHAM

- C.H.I.P.S. Computer Shop Clarks Yard, Darlington. Tel: 0325 381048

- Topsoft 6 Wallington Court Mews, Grange Road, Darlington. Tel: 0325 486689

## DERBYSHIRE

- DK Sound & Vision 7 Lightwood Road, Buxton, Derbyshire. Tel: 0298 72066

- Gordon Horwood 69-71 High Street, Alfreton, Derbyshire. Tel: 0773 836781

- Microfun 14 Stephenson Place, Chesterfield. Tel: 0246 550202

## DEVON

- Computerbase 21 Market Avenue, City Centre, Plymouth. Tel: 0752 672128

- The Games Cupboard 5 New Bridge Street, Exeter. Tel: 0392 214128

- The Model Shop 11 Old Town Street, Plymouth. Tel: 0752 221851

## DORSET

- Computer-a-Tape 5 Great George Street, Weymouth, Dorset. Tel: (0305) 781745

## EAST SUSSEX

- Computerware 22 St Leonard's Road, Bexhill-on-Sea, East Sussex TN40 1HF. Tel: 0424 223340

- Software Centre 31/32 Churchhill Square, Brighton, East Sussex. Tel: 0273 776576

## EIRE

- Computer Leisure Centre, 6 Lower Mallow Street, Limerick, Ireland. Tel: 010 3536189211

- Virgin Games 14-18 Aston Quay, Dublin 2. Tel: 0001 777180

## ESSEX

- Computera 88/90 London Road, Southend on Sea. Tel: 0702 335443

- Estuary Computers Victoria Precinct, Southend on Sea, Essex. Tel: 0702 614131

- Software Plus 336 Chantwell Square, Southend. Tel: 0702 610784

- Software Plus Liberty Shopping Hall, Basildon. Tel: 0268 27922

- Software Plus 15 Kingsway, Colchester. Tel: 0206 769977

- Software Plus Unit 1, 28/31 Moulton Street, Chelmsford. Tel: 0245 491746

- Software Plus Unit 1 Queensgate Centre, Orsett Road, Grays. Tel: 0375 391164

## GLOUCESTERSHIRE

- G. D. Computer Software 9 Market Parade, Gloucester. 0452 307108

- The Model Shop 79 Northgate Street, Gloucester. Tel: 0452 410693

- The Model Shop 22 High Street, Stroud. Tel: 0433 65920

## GREATER MANCHESTER

- Microbyte Unit 176, Halle Mill, The Ardale Centre, Manchester. Tel: 061 832 1438

- The Computer Shop Unit 121, Market Way, Manchester. Tel: 061 832 0878

- Vudata 203 Stamford Street, Ashton-under-Lyne, Lancashire. Tel: 061 339 0326

## HAMPSHIRE

- Columbia Computers 17 Columbia Road, Embury Park, Bournemouth. Tel: 0202 535542

- Micro Centre 13 London Road, North End, Portsmouth. Tel: 0705 697802

- G.B. Microland 7 Queen's Parade, London Road, Waterlooville. Tel: 0705 239911

- Software Plus Unit 8, The Boulevards, Wallington Centre, Aldershot. Tel: 0252 29862

- Ultima 118 East Street, Southampton. Tel: 0703 639419

## HEREFORD & WORCESTER

- Antica 16 St. Swinton Street, Worcester. Tel: 0905 22335

- G. D. Computer Software 37 Upper Tything, Worcester WR1 1JZ. Tel: 0905 726259

## HERTFORDSHIRE

- Faxminster 23 Market Square, Hemel Hempstead, Herts. Tel: 0442 55044

- Software Plus Unit 94, Inshope, The Maltings, St. Albans. Tel: 0727 64347

- Software Plus 13 Town Square, Stevenage. Tel: 0438 742374

- The Games Keeper 10 Station Road, Letchworth, Herts. Tel: 0462 672647

## KENT

- Computer Leisure Centre 117 High Street, Orpington. Tel: 0689 21101

- Silica Shop 1-4 The Mews, Hatherley Road, Sidcup. Tel: 01 302 8811

- Software Plus 35 High Street, Gravesend. Tel: 0474 333162

- Software Plus Unit 2, 4-6 Orange Street, Canterbury. Tel: 0227 438112

- The Micro Machine 354 High Street, Chatham, Kent. Tel: 0634 831870

## LANCASHIRE

- Alan Heywood 174 Church Street, Blackpool. Tel: 0253 21657

- Bits & Bytes Tite Bam Street, The Rock, Bury. Tel: 061 764 1989

- PV Computers 104 Abbey Street, Accrington. Tel: 0254 35345

- PV Computers 97 St. Albans Road, St. Anne's. Tel: 0253 722969

- The Computer Shop 4 Friargate, Preston, Lancashire PR1 2AU. Tel: 0772 201482

## LEICESTERSHIRE

- May's Computer Centre 57 Churchgate, Leicester. Tel: 0533 22212

## LONDON

- Barkman Computer Services 6/9 Market Place, Kingston Upon Thames KT1 1VY. Tel: 01 546 5941

- Doublevision 32 High Street, Ealing, London. Tel: 01 566 1004

- Erol Computers 125 High Street, Walthamstow, London. Tel: 01 520 7763

- Logic Sales 19 The Broadway, The Bounce, Southgate. Tel: 01 882 4942

- Microtek Grove Green Road, Leytonstone. Tel: 01 566 2275

- Shekhana 221 Tottenham Court Road, London. Tel: 01 889 9412

- Shekhana Computers 2 Gladstone House, Gladstone Avenue, High Road, Wood Green. Tel: 01 631 4267

- Silica Shop 52 Tottenham Court Road, London. Tel: 01 580 4000

- Software Plus Inshope, 37-43 South Mol, Edmonton Green Shopping Centre. Tel: 01 803 8581

- Virgin Games 100 Oxford Street, London. Tel: 01 637 7911

- Virgin Games 527 Oxford Street, London. Tel: 01 491 8582

- Virgin Games Store 14-22 Oxford Street, London. Tel: 01 631 1234

## MERSEYSIDE

- Bits & Bytes 18 Central Station, Ranelagh Street, Liverpool. Tel: 051 709 4036

- Computer Adventure World Rank Buildings, 1a Charing Cross, Birkenhead, L41 6EJ. Tel: 051 666 1132

- Micro Snips (Mail Order), 37 Seaview Road, Wallasey, Merseyside. Tel: 051 630 3013

## MIDDLESEX

- J.K.L. Computers 7 Windsor Street, Uxbridge, Middlesex. Tel: 0895 51815

## NORFOLK

- Computer Plus 40 New Conduit Street, Kings Lynn, Norfolk. Tel: 0553 774550

- One Step Beyond 11 Castle Meadows, Norwich, Norfolk. Tel: 0603 663796

- Software Emporium 77/87 Magdalen Street, Norwich, Norfolk. Tel: 0603 633362

- Viking Computers Andrey Rise, Catton Green Road, Norwich. Tel: 0603 425209

## NORTHAMPTONSHIRE

- A-Z County Supplies 230 Lower Mall, Weston Favell Centre, Northampton. NN3 4JZ. Tel: 0604 414528

- Complete Computing 1 Central Buildings, Railway Terrace, Rugby. Tel: 0788 72309

- Softspot 42 High Street, Coventry, Northants. Tel: 0327 79020

## NORTH YORKSHIRE

- The Computer Shop 7 Burton Arcade, Leeds LS1 6HQ. Tel: 0532 340455

- The Computer Store 14 St. Sampson's Square, York. Tel: 0904 646934

- The Games Centre 33/34 St. Nicholas Cliff, Scarborough, North Yorks YO11 2ES. Tel: 0723 365221

- York Computer Centre 9 Davygate Centre, Davygate, York. Tel: 0904 641862

## NOTTINGHAMSHIRE

- Belshaws Computer Shop 51 Balderton Gate, Newark, Notts NG24 3EQ. Tel: 0636 72593

- The Computer Shop Unit 230, Victoria Centre, Nottingham. Tel: 0602 410633

- Long Eaton Software Centre Commerce House, West Gate, Long Eaton NG10 1EG. Tel: 0602 728555

- Micro Byte 27 Goosegate, Hockley, Nottingham. Tel: 586454

- Microbyte Unit 109, Upper Broadwalk, Broadmarsh Shopping Centre, Nottingham. Tel: 0602 586454

- North Notts Computers 23 Oatram Street, Sutton in Ashfield, Notts. Tel: 0623 556686

- Virgin Games 6-8 Wheeler Gate, Nottingham. Tel: 0602 476126

## OXFORDSHIRE

- Club Computers 6 Evans Yard, Bicester, Oxon. OX6 7ST. Tel: 02357 4831

- Softspot 5-6 Broad Street, Banbury, Oxon. OX16 8BN. Tel: 0295 68921

- Witney Computer Centre 105 High Street, Witney, Oxfordshire. Tel: (0993) 778294

## PETERBOROUGH

- Logic Sales 6 Midgate, Peterborough. Tel: 0733 49666

## SCOTLAND

- Capital Computers 12 Home Street, Tollcross, Edinburgh. Tel: 031 228 4410

- Computer Centre 32 Princess Street, Alloa. Tel: 0259 722932

- Computer Centre 50 Bannock Street, Stirling. Tel: 0786 64175

- Database Computers 42 East Port, Dunfermline. Tel: 0383 724597

- Database Computers 93 Graham Street, Airdrie. Tel: 0236 47097

- Falkirk Computers 242 Grahams Road, Falkirk. Tel: 0324 612989

- Graffix 304 High Street, Kircaldy. Tel: 0592 265569

- Graffix 9 Albert Street, Leith Walk, Edinburgh. Tel: 031 553 6155

- Inverness Computers 15 Market Arcade, Inverness. Tel: 0463 226205

- The Computer Shop 75 Rosemount Viaduct, Aberdeen AB1 1NS. Tel: 0224 647875

- The Micro Shop 271/275 Dumbarton Road, Glasgow. Tel: 041 339 0832

- Vic's Computer Supplies 31-33 South Street, Perth, Scotland. Tel: 0738 36704

- Virgin Games 131 Princes Street, Edinburgh. Tel: 031 225 4583

- Virgin Games 28-32 Union Street, Glasgow. Tel: 041 204 0846

- Virgin Games Centre Argyle Street, Glasgow. Tel: 041-221 2606

## SOUTH HUMBERSIDE

- The Computer Store 42 High Street, Southorpe. Tel: 0724 857985

## SOUTH YORKSHIRE

- Crazy Joes 145 Ellingham Street, Rotherham, South Yorkshire. Tel: 0709 829286

- Just Micro 22 Carver Street, Sheffield. Tel: 0742 752732

- Microgamer 20 Cleveland Street, Doncaster. Tel: 0302 329999

- Micro Fun Unit 12, Guardian Centre, Rotherham. Tel: 0709 360000

- Micro Fun 10 Paul Street, Barnsley. Tel: 0226 207063

- Micro Fun 83 Holme Lane, Hillsborough, Sheffield. Tel: 0742 345002

- The Computer Store 44 Market Street, Barnsley, S. Yorkshire. Tel: 0302 21134

- The Computer Store 21a Prising Office Street, Doncaster. Tel: 0302 25260

## STAFFORDSHIRE

- Burton Software 31/2 High Street, Burton on Trent, Staffs. Tel: 0283 34388

- Fosters 59, Tamworth Street, Lichfield, Staffs. Tel: 0543 262341

- Miles Better Software 219/221 Cannon Road, Chaddesworth, Corrook. Tel: 0543 466377

- Software City 59 Foregate, Stafford. Tel: 0785 41899

## SUFFOLK

- Bits & Bytes 47 Upper Orwell Street, Ipswich. Tel: 0473 219961

- Bits & Bytes 19 Orwell Road, Felixstowe, Suffolk. Tel: 0394 279266

- Softsellers 50 Dogs Head Street, Ipswich. Tel: 0473 57158

- Software Plus 22 St. Matthews Street, Ipswich. Tel: 0473 54774

## SURREY

- The Model Shop 89a Woodbridge Road, Guildford. Tel: 0483 39115

- Ultima White Lion Walk, Guildford. Tel: 0483 506939

## TYNE & WEAR

- Microbyte 56 Garden Walk, The Metro Centre, Gateshead. Tel: 091 460 6054

- Microbyte The Green Market, Newcastle-upon-Tyne, Tyne & Wear. Tel: 091 261 9050

- Sunderland Computer Centre 29 Crowtree Road, Sunderland. Tel: 091 565 3711

- The Computer Shop 7 High Friar, Eldon Square, Newcastle. Tel: 091 261 6260

- The Computer Shop 9 Maritime Terrace, Sunderland. Tel: 091 310 8142

## WALES

- Allsorts 39 Cross Street, Aberystwyth, Gwent. Tel: (0873) 6903

- Antics 22/24 Castle Arcade, Cardiff. Tel: 0222 229065

- E.C. Computers Glamorgan House, David Street, Cardiff. Tel: 02



# Midwinter

It's nearly five years since Mike Singleton launched *Lords of Midnight* upon an unsuspecting games world. The program offered a whole new dimension of games-playing experience by combining strategy with the revolutionary 'landscaping' technique. 250,000 troops, lots of player characters to recruit, and thousands of graphic locations made it a true record-breaker.

Unfortunately none of Mike's later games really lived up to the promise of LOM. Although *Doomdark's Revenge* and other titles were impressive, they lacked the magic combination of simplicity, immediate appeal, and strategic interest that made LOM a winner. The long wait for a true successor to *Lords of Midnight* may now be over.

The scenario for *Midwinter* is simple but compelling. Just as the world gets used to global warming and is casting around for a solution to the problems of the rising sea-levels, along comes a massive meteorite that blasts into the jungles of Burma with the force of a 10000 megaton bomb. Dust and debris are hurled into the atmosphere, cutting off the sun's rays and leading to a rapid cooling of the earth's temperature. And if that wasn't bad enough, a second natural catastrophe (volcanic explosions caused by an earthquake in Central America) compounds the situation. Earth temperatures plummet to -25 degrees and *Midwinter* has set in.

One of the first attractions of the game is the detailed research that has been put into the scenario. It may sound horrific, but every element has been closely vetted by experts at the Climate Research Unit of the University of East Anglia, one of the world's main sources of expertise in this subject. Whichever bit of the scenario you try to knock, the result is a solid chunk of authority and not the hollow ring of fiction. Which makes playing the game far more compelling...

Set on the island of *Midwinter*, the plot is simple but effective. *Midwinter* is a 400-mile long landmass formed by falling sea-levels. Authenticity is the keynote again: the topography of the island was fixed after the game design team checked out Admiralty charts for the Azores area.

In the new Ice Age, *Midwinter* offers salvation to a small group of pioneers who, by establishing heat mines (authenticity again: the designs were taken from similar establishments in Iceland), have created a more hospitable environment. After a generation of successful colonisation, the islanders awake one morning to discover they have lost contact with their colleagues living in the southern-most parts of *Midwinter*. Someone, it seems, is intent on seizing their island sanctuary and, in doing so, condemning them to death from cold and starvation.

## COLD WAR

The scenario of the game from this point on combines strategy and action in a manner very similar to *Lords of Midnight*. Just as in that game you were attempting to halt the advance of *Doomdark's* forces either by destroying them or by penetrating *Doomdark's* stronghold, so in *Midwinter* you must prevent the heat-

2000 troops,  
32 player characters,  
10000 control points...  
Microprose/Rainbird  
prepare to launch Mike  
Singleton's latest  
blockbuster.



The *Midwinter* team: (l/r) Martin Moth, Paul Hibbard, Rob Davies, Peter Jones, Hugh Batterbury, and Mike Singleton.

mines from falling into enemy hands, recruit allies from amongst the other islanders, and force either a military or strategic victory. Whatever happens, you have to destroy the enemy camp at the south of the island. If all the heat-mines are captured, you lose...

The similarities to *Lords of Midnight*, however, are soon forgotten when you start playing. Unlike LOM you have a full-scale 3D fractal generated landscape to travel over. Furthermore there are three different ways of travelling (skiing, ice-buggy, or hang-gliding) and each has certain tactical implications in terms of speed, vulnerability, and the ability to access certain parts of the island.

Strategy is more dominant in *Midwinter* too, since the program offers very comprehensive mapping functions that enable you to track enemy movements and generate battle plans on a large scale. Information on the current status of the struggle is therefore easily available at any time.

You have to recruit up to 32 allies in the struggle against the invaders. Here again there have been considerable advances over the early Singleton titles. Each character has a complex profile and history that makes relationships vital in establishing alliances. This all adds to the strategic elements, together with your characters' differing skills in a wide range of areas.

The graphic display of the game is superb. *Midwinter* makes clever use of a limited palette to display a detailed fractal landscape that scrolls very rapidly in all directions. Land contours are all faithfully imple-

## ON YER SNOW BIKE!

There are four principal means of transport in *Midwinter*, each with a corresponding view of the surrounding landscape.



▲ Your ski-goggles...



▲ This is the view from your buggy cabin: buggies are fast and secure, but there are some places they can't reach. Much used by the opposition.

Hang-gliding is THE way to travel, always provided you can find a thermal updraft. Here you're out over the cliffs. Note the 'misty' horizon...





mented, so that if you follow an enemy snow buggy you can see its tail rise and fall as it negotiates the icy slopes. Ski too fast down one hill, and you could come to grief if there's a steep slope up the other side of the valley. Topography plays an essential role in the strategy of the game, its implications ranging from simple ambush techniques to the feasibility of hang-gliding from one cliff-top to another. Even the thermals are linked, as in real life, to the terrain below.

Gameplay is quick and easy, driven by a selection of attractive icons that enable you to move between various command modes. Once in control of a character your principle actions are driven either from the movement or decision screens. You can swap characters at any time, wherever they may be, provided you have previously recruited them - you start with just one and must make friends quickly to survive. The game has that classic combination of simplicity and depth that could well make it a winner.

### GAME OF THE YEAR?

Microprose have gone through several major changes recently. After first acquiring the three Telecomsoft labels, and marketing the Incentive games, they even stretched to forming two new labels of their own, Microstyle and Microstatus. After learning a few tough lessons, the company have now settled down and are planning a new Advanced Computer Entertainment strategy... Fewer games, more time and money spent on development, and hopefully what we'll miss in terms of quantity will be made up by quality.

Since releases like M1 Tank Platoon and Gunship were scarcely negligible achievements, it's difficult to see exactly how much more resources Microprose

## MAPPA MUNDI

The map screens in *Midwinter* are especially impressive. The display is built around a 20 million triangle, fractal generated landscape. A button panel enables you select different displays, pinpointing characters, heat mines, and other game elements.

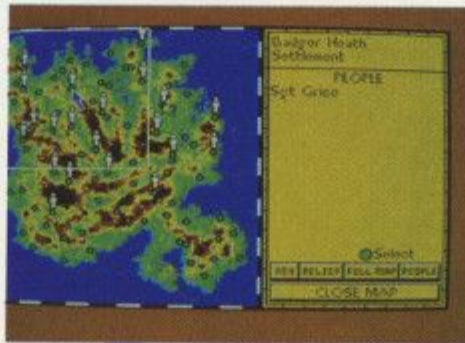

▲ Here you are at full zoom-out, with the 'character current location' option selected.



▲ You can zoom in and use buttons to select different features.

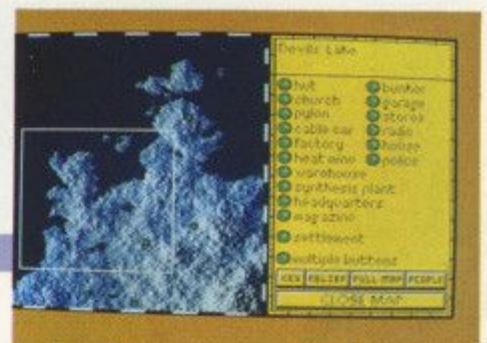

▲ You can select light-source shading too, useful for planning tactical manoeuvres.



**Constable Harvey Pringle**  
Peace Officer  
Age 28 years  
Current Location:  
White Horse Valley

Easily taken in, Harvey Pringle has been swindled many a time by Flint without even realizing it. He regards Macleod and Flynn as good friends but, in truth, they have little time for him. Pringle blames Chabrun entirely for leading his wife astray and now suspects, quite falsely, that Pudzinski and Jessop have the same intentions.

### QUALITIES AND SKILLS

Morale	Excellent
Energy	Excellent
Alertness	Excellent
Endurance	Excellent
Sturdiness	Excellent
Optimism	Good
Strength	Good
Stamina	Abysmal
Sharpness	Abysmal
Shiing	Fairly Good
Gliding	Fairly Good
Driving	Average
Sniping	Below Par
Sabotage	Below Par



▲ Complex character attribute screens are backed up by comprehensive details in the manual. You have to take careful note of who's who and what their particular likes and dislikes are as these factors affect recruitment and tactics.



◀ This is the view through your sniper-scope. You've got an enemy buggy in your sights. They bob up and down convincingly as they negotiate the terrain.

## MIDWINTER TECHNO-PORN

**Map:** dual display ('satellite view' (light-source shading) and topographical)  
10000 control points  
fractal generated, equivalent to 40Mbytes of data.  
20 million triangles of graphic display  
3000 unique place names  
400 miles of playing area at game level

**Characters:** 32 player characters  
14 attributes and skills  
2000 invading troops

**Display:** Up to two mile view  
Up to 400 triangles per frame  
Buildings have up to 30 faces



▲ Down in the 'real' world, some of the features are fairly complex. Here you are outside a village: that's a heat-mine on the left.

can put into a game (Tank, for example, had a manual that weighed in like a coffee table book) and still make a profit. 'We're relying entirely on the quality of the product,' answered marketing director Peter Jones. 'This game is far and away the biggest project we have ever undertaken. It's arguably the largest project ever undertaken for a home computer. We genuinely believe it's the beginning of a whole new generation of computer software.'

Hmmm. We've heard some of this before, we think! But however sceptical you may be about the claims, you can't argue with the facts. We've already sat down and delved into the world of *Midwinter* and we reckon it just might be THE big game of 1990. Naturally we're reserving final judgement until we've carried out more in-depth play-testing: watch out for the definitive ACE verdict next month...



# THE MISSION IS VITAL – THE ODDS ARE AGAINST YOU.

## F15 Strike Eagle II

F15 Strike Eagle II is a whole new concept in computer air warfare. Dogfighting is the name of the game. The air swarms with enemy aircraft. Dice with death as you light your 'burners' and head for the skies. Success depends on making the right moves – fast. Super smooth, non-stop action takes place over 250,000 square miles of authentic terrain. Superb, solid-filled polygon based 3D graphics makes it feel as though you really are in the thick of the action. Hundreds of options, four difficulty levels and a vast amount of missions and scenarios make F15 Strike Eagle II perfect for dogfighting veterans and novices alike.

## F-19 Stealth Fighter

MicroProse's F-19 Stealth Fighter transports you into the real world of Stealth Technology. Placed in charge of one of the USAF's most valuable and secret aircraft, you must carry out missions deemed too dangerous for normal aircraft to accomplish. Amazing three-dimensional graphics add a totally new dimension to F-19 Stealth Fighter as you fly, undetected, at 75 feet around Berlin and strike deep within Communist territory. F-19 is not just a flight simulation – it's an experience!

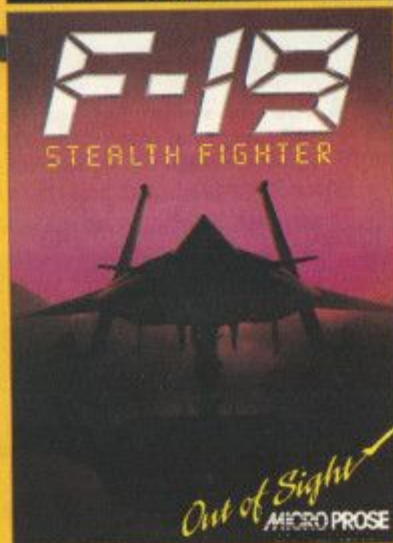

## Gunship

Gunship has proved itself to be one of the truly great combat flight simulations. Based on the AH-64 Apache, one of the most advanced attack helicopters in the world and developed with the help of real attack helicopter pilots, Gunship lets you loose on a high-performance helicopter that can fly low and slow, hover, sideslip, fly backwards, rotate and go into a full-blooded, 200 knot power dive through some of the hottest combat zones in the world. In the face of adversity, it is a brave heart and sharp mind that matters more than the technology behind the man. The spirit of attack is all...

# MICRO PROSE

SIMULATION • SOFTWARE

MicroProse, Unit 1, Hampton Road Industrial Estate, Tetbury, Glos, GL8 8DA. *stein*



# WHAT'S THE SCORE?

MicroProse's action games feature a depth of realism, excitement and strategy rarely seen before in computer entertainment.

## TWO SCORE GOLD PIECES

Pirates, played by over a quarter of a million square miles, offers unparalleled gameplay and adventure on the high seas;

## SCORE TO SETTLE

Airborne Ranger's fast-paced action challenges your skills and reflexes over a dozen missions deep behind enemy lines.

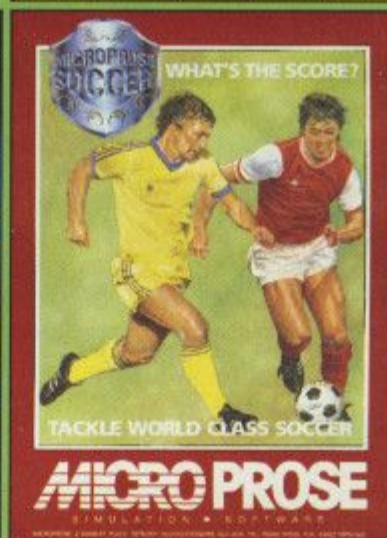
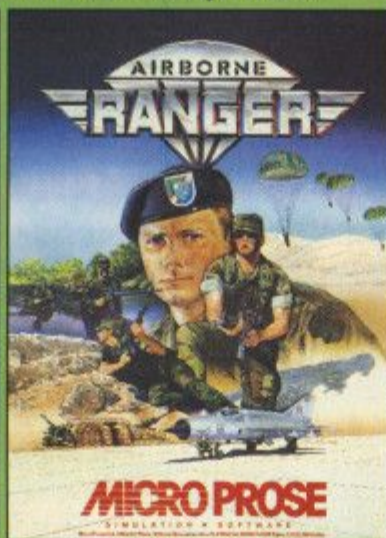
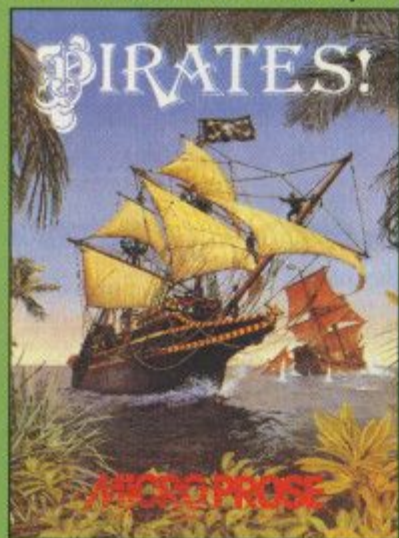
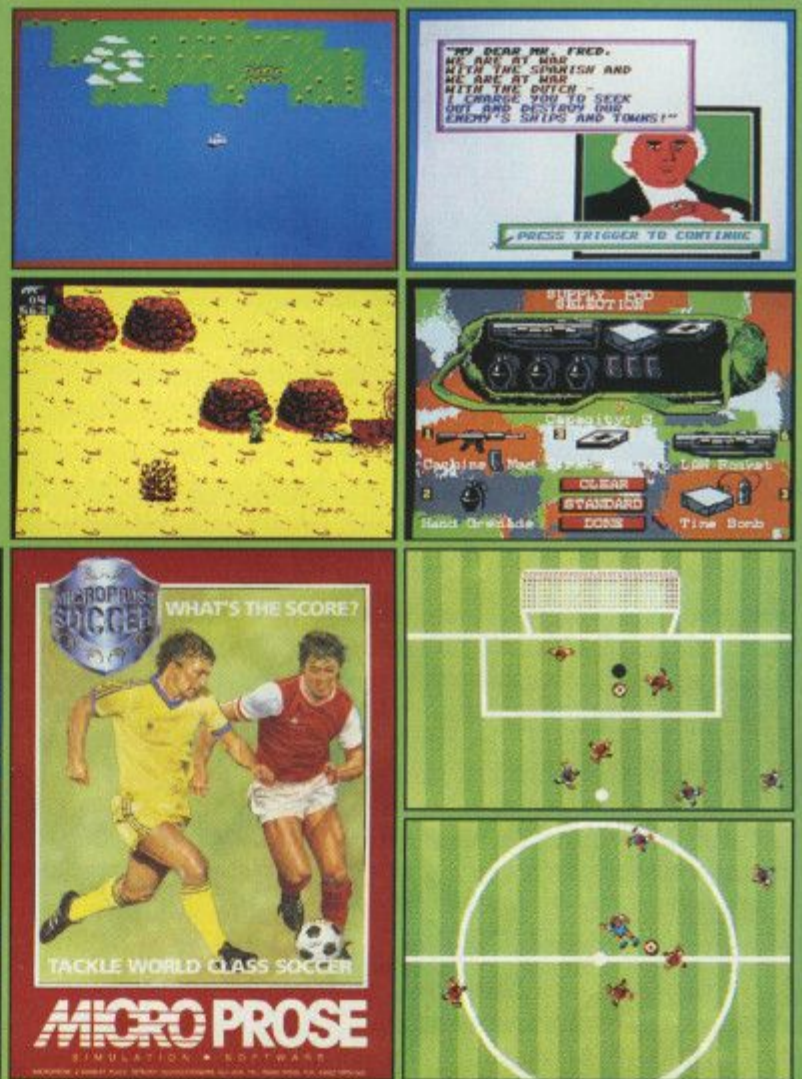

## WHAT'S THE SCORE?

Soccer was the world's first true football simulation – from indoor league to World Cup Final, it's just like the real thing;

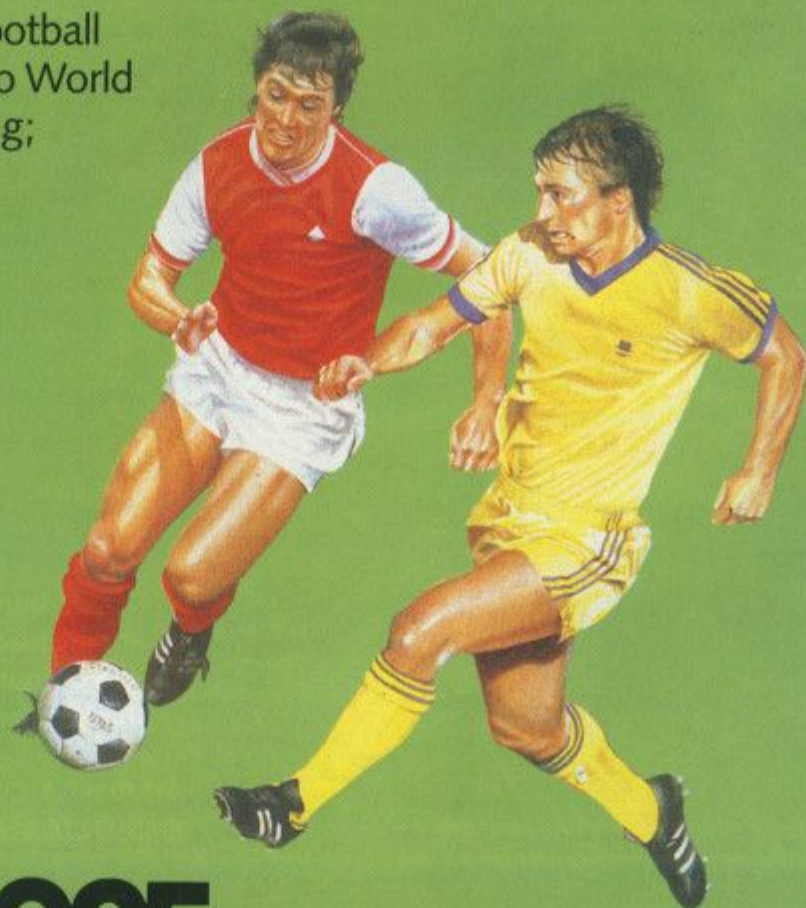

**MICRO PROSE**  
SIMULATION • SOFTWARE

MicroProse, Unit 1, Hampton Road Industrial Estate, Tetbury, Glos, GL8 8DA.



# NO MERCY-NO SURRENDER

A NEW 3D DUO FROM LOGOTRON ENTERTAINMENT

## BAD COMPANY...

**Y**ou've fallen into Bad Company. In this place there are no good guys, just you, your sidekick and wave upon wave of insectoid enemies who have just one thing in mind - the total destruction of every human they set their nasty little bug eyes on. No quarter is asked and none is given, you know what to do - if it's alien, blast it!

Bad Company is programming legend Steve Bak's latest and greatest masterwork with scrolling of vanishing point perspective surfaces, the latest superfast 3D sprite techniques and featuring:

- Simultaneous two-player option
- Unique choice of weaponry, with fire power boosters
- Choice of eight different combat heroes
- Uncountable waves of sickening insectoid attack

ATARI ST & COMMODORE AMIGA  
END NOVEMBER '89. PRICE £24.99



ATARI ST SCREEN SHOT

## STAR-BLAZE...

**S**tarBlaze is pure solid vector 3D Shoot 'em Up from the programmers that brought you 16 bit Elite! To qualify as a Tamsinian warrior in an intergalactic war of unparalleled ferocity, you must prove your prowess by taking on scores of fiendish alien attack waves and live to tell the tale. How will you do it? With quick reactions and the fastest trigger finger on the planet!

StarBlaze is a game which draws upon the strongest features of the classic arcade titles to introduce a wholly original style of game to the arcade genre, featuring:

- Over a hundred different attack patterns
- Action-packed gameplay in stunning solid 3D
- Five colourful backdrops (forget boring starfields)
- Shield, smart bomb and extra power pickups

ATARI ST & COMMODORE AMIGA  
END OCTOBER '89. PRICE £19.99

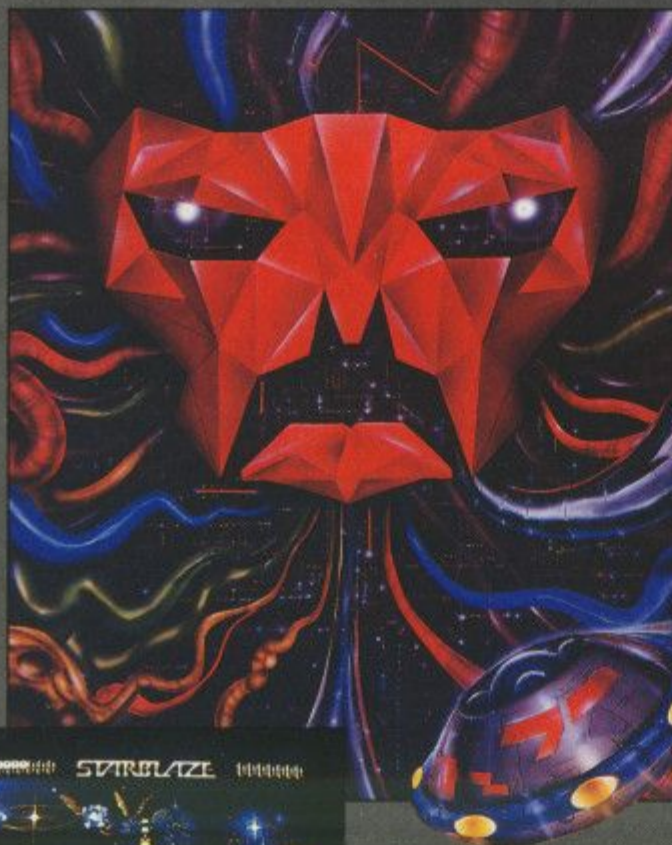

ATARI ST SCREEN SHOT



TM  
**LOGOTRON ENTERTAINMENT**

CHANCERY HOUSE, 107 ST PAULS ROAD, LONDON W1 3SN

The Logotron name and mark are used under license from Logotron Limited.



# KEEP THE THIEF



**E**very adventurer worth his or her salt makes good use of the TAKE or GET command – but *Keep the Thief* puts a rather different slant on this innocuous pastime. Rather than allow you to wander round the world blithely looting shops and houses with the owners simply turning a blind eye, the game takes a rather more realistic view of theft. Get caught TAKEing anything in the city of Tel Mercon and it's curtains...

You take the title role, in permanent exile from your home town for persistent anti-social behaviour. Your new hunting ground is the Tri-City area and the city of Tel Mercon in particular, where once the evil God-King Telloc held sway. Here, rich pickings are on offer for the successful thief, but Keef has much to learn in order to survive, let alone become the new God-King which is your ultimate objective. Since rumour has it that the all-powerful Telloc – banished by peasant revolt – is still alive somewhere in the land, it's questionable whether this objective is entirely level-headed.

Starting in the jungle near the city, your first necessity is to equip yourself with weapons and armour to give you a fighting chance of survival. Unfortunately such items are expensive so you'll either have to steal them from under the nose of the smith or look around for valuables which are less well guarded elsewhere.

The streets of Tel Mercon contain some pretty wealthy households who often leave valuables lying in full view and apparently unguarded. However some citizens are rather less trusting than their fellows and use a variety of subtle traps to protect their goods from the likes of you. Armed guards on patrol are a further hazard, so you might try your luck in the jungle instead, where the pickings are not so

rich but the monsters and outlaws there generally carry some personal wealth, and even, occasionally, useful items of weaponry and armour.

The screen display is divided into several sections. The top half shows either a still graphic of your location, a 3D representation of the combat area, your spell mixing cloth and ingredients, and a direction indicator.

During combat an overhead view of the combat area is shown as a small scale map supported by a radar like display of your direction of view. Below this is a long narrow panel in which any trees or monsters are shown in 3D perspective.

Below the main display is the heart of the control system. A set of boxes show currently available command words. Clicking on these either implements the command or calls up a further sub-menu. The system is very easy to use and quick to learn.

In addition to icons, many housekeeping functions are available on the menu bar including options to reduce the numbers and nasti-



ness of random monster encounters - very useful while finding your feet. Several status displays are also available from the menus. Your abilities in stealing and disarming traps are shown as both percentages and partially filled bars as are general attributes such as strength, hit points and magic points. You can also monitor current levels of sleepiness, hunger and drunkenness. All the displays are clear and easy to read and instantly accessible at any time.

All good fantasy worlds cater for magic and this is no exception. Spells are created by

It's a steal!  
**ELECTRONIC ARTS** have come up with a novel adventure, featuring RPG influences, a menu-driven operating system, and a sense of humour.

mixing ingredients on your spell cloth and include such gems as Bandus Aidus for healing and Flickus Bickus for light. To mix spells you need to own the appropriate spellbook of which there are several to find, then decipher the cryptic clues given to decide which reagents are needed. While many common reagents are available at the herb shop, more exotic numbers can involve a long and dangerous trek to acquire.

Combat takes place in real time and requires both tactics and fast reactions at times. Both ranged and close quarter weapons can be used as may some spells if already prepared. But be warned, once in combat the battle is to the death, usually yours, so save often as ambushes are frequent.

*Keep the Thief* is a well crafted RPG which should offer hours of exploration and discovery. The whole game is shot through with humour, often in the form of insults and put-downs, which help to set and maintain a very enjoyable atmosphere. Its style is a nicely welded combination of traditional adventure and character building with plenty of flexibility to explore and try out ideas.

#### LANDSCAPE .....80

Clear, colourful graphics, somewhat spoilt by inconsistent movement techniques. Dungeons are rather sparsely drawn and not up to the standard of other locations.

#### ENCOUNTERS.....75

Lots of non-hostile characters against whom you can pit your wits and skill, although conversation is limited to set responses.

#### CHALLENGE.....85

While not too difficult to play, the sheer range of options to be considered simply to survive will provide hours of enjoyable play.

#### SYSTEM .....80

Very easy to control, but changes of movement style

### ACE RATING 850

*Keep The Thief* offers a fresh and original approach to the genre. Likely to appeal to both RPG and text/graphic addicts it provides a lasting challenge for experienced and novice players alike – and it's hilarious!



# MYSTERY OF THE MUMMY

A quick glimpse at a new detective-style graphic adventure from RAINBOW ARTS. In the style of some of the recent French mysteries (*Mortville Manor*, for example) you explore Hamburg in a search for a missing mummy...

The year is 1912, the place Hamburg in this new adventure from Rainbow Arts. Programmed by Time Warp, the game casts you as a lawyer who, together with his driver/companion Wilhelm, is approached by local resident Rudolf Rabensberg.

It seems a mummy belonging to Mr Rabensberg's father was stolen from an exhibition several years ago and never recovered. Now news has reached his son that an important African mummy is to be put up for auction. Your task is to discover whether the two mummies are in fact one and the same. As a typical jetsetter of the era, you are due in Munich on Thursday and today is Sunday - your time is therefore limited.

The screen display is divided into sections which show a clock with the current time, a short text description of your location and conversations with other people, a set of icons for

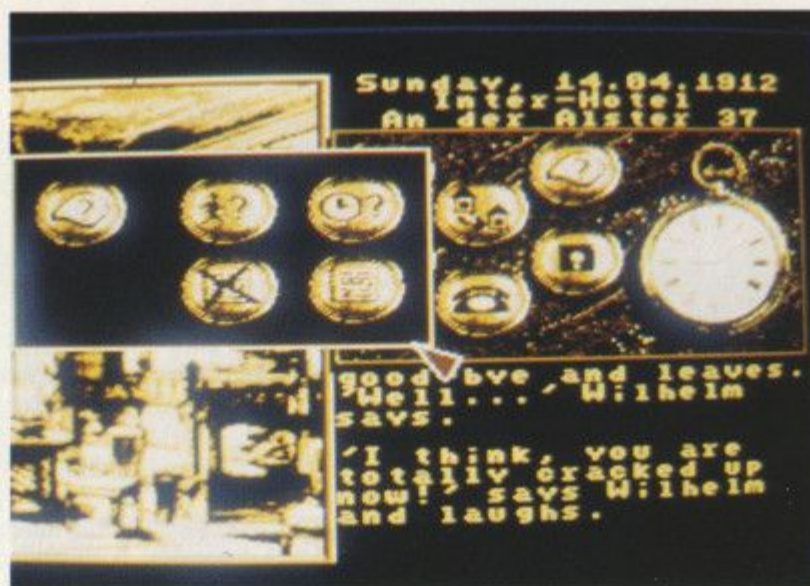

controlling the game, a picture of your location and four bars showing your level of money, hunger, thirst and tiredness. Input is a mixture of mouse/icon and typing (addresses, names etc).

either on foot or by car.

Since I haven't got very far into the game yet I'm reluctant to give this one the benefit of a full rating. Stand by for more details next month.

# DRAGONS OF FLAME

US GOLD continue the *Heroes of the Lance* saga but tone down the hack'n'slay elements.

Remember *Heroes of the Lance*? Did you manage to recover the Disks of Mishakal from Khisanth the guardian? If so, you'll enjoy this follow-up in the *Dragonlance* series.

Draconian forces have spread out across the face of Krynn with only the Qualinesti elves still holding out. Although the elves will fall the Companions still have a chance to free the slaves of Pax Tharkas and recover the long-lost Wyrmslayer. The Companions must run the gauntlet of swarming Draconian forces to succeed.

Play takes place in the open initially with the party seen from overhead as they move about the countryside. However the Draconian forces are everywhere and battle is joined from the first moments of the game.

As combat becomes imminent the overhead view changes to the more familiar side-on shot as used in *Heroes*. Fighting is a matter of aiming low, middle or high at the enemy or casting ranged weapons such as spears from a safe distance. If you're anything like me you'll find yourself frantically waggling the joystick anywhere just to stay alive! Following combat the press of a key returns the screen to an overhead view.

All your characters are shown in cameo at

the bottom of the screen together with a compass pointer on the left. Accessing commands is achieved by pressing the space bar to bring up the main menu. From here various actions can be selected such as spell casting, changing the marching order, manipulating objects, saving/loading etc. Also available is a command to show a map of the whole area of the quest in case you get lost.

Pax Tharkas is made up of several levels containing a variety of secret doors and traps and is very similar to *Heroes* visually with your character shown side-on against the background scenery of walls, doors, passages etc.

The display's improvement however. Bright primary colours make identifying objects and characters much easier and quicker which in turn makes the game more friendly than its predecessor.

While *Heroes of the Lance* had too much of the hack & slay and too few strategic elements for my liking, *Dragons of Flame* seems to have a far better balance, therefore appealing to a wider range of adventure tastes. Although basically an arcade adventure, the game contains enough puzzle elements to satisfy most followers of the fantasy genre.



Colours in *Dragons* are much less muddy than they were in *Heroes* and easier on the eye to boot.



THE DEEPEST  
GAME EVER...

# Aquanaut

The company that produced "The Kristal" bring you an inter-active arcade adventure written in the spirit of 1940's cinema heroes, taking place deep under The Ocean in a maze of underwater caverns and then in the Fabled City of Atlantis. Surmount the perils of the deep with a clever strategy and slick joystick control ... the underwater world could be yours.



Screen shots from various systems.



Mermaid in Britain



FROM THE PRODUCERS OF "THE KRISTAL"

Available On:  
Atari ST, Amiga  
**£24.95**

SURMOUNT THE PERILS OF THE DEEP

PRISM LEISURE CORPORATION PLC  
Unit 1, Baird Road,  
Enfield, Middlesex  
EN1 1SJ.

**Addictive**  
LIVE THAT DREAM

Swordfish and Jellyfish

SMASH The Ramanishi SHOOT your way to Victory SAVE The World.

HUNT for hidden clues INDH

SWIM 20 miles underwater

BATTLE really nasty creatures

FIND The Lost City of Atlantis

AVOID Mutant Sharks,



# POWER UP

# POWER UP YOUR 16 BIT

WITH THIS MACHINE DEDICATED ORIGINAL SOFTWARE

FOR ONLY £9.99



Throughout its long history, France has seen many disasters and spectacular events. During the XV century, this land was close to extinction ... a miracle was needed. That Miracle was Joan of Arc.

Available on:  
Atari ST • Amiga • IBM PC



Screen shots from various formats.

Is it a dream? Certainly not!!! Hollywood Poker Pro takes you into the exciting world of high stakes gambling. Realistic and testing game play against your choice of 1 to 4 of the most accomplished and glamorous players you'll ever meet - they not only look fantastic, they play a mean game of poker too.

Available on: Atari ST • Amiga



Screen shots from various formats.



JOURNEY TO THE CENTRE OF THE EARTH



UNIQUE SOFTWARE SPECIFICALLY WRITTEN FOR THE 16 BIT MACHINE. UNIQUE QUALITY FROM RAINBOW ARTS. UNIQUE VALUE NOW AVAILABLE AT ONLY £9.99.

Look out for the following great titles:

REALM OF THE TROLLS™  
GRAFFITI MAN™ • GARRISSON™ • GARRISSON II™  
DANGER FREAK™ • TO BE ON TOP™ • FUTURE TANK™  
MECHANICUS™ • DETECTOR™



Rainbow Arts (UK) Ltd  
65 Sketty Close  
Brackmills Business Park  
Northampton  
NN4 0PL

**Rainbow Arts**



# TRICKS 'N' TACTICS

FEELING LOST? TNT GETS THOSE TRICKY GAMES MAPPED OUT

## TV Sports Football

If you enjoyed this game as much as I did then by now you are probably at the stage where you want to improve your playing skills. These 16 gems from M.Dhooper of Belvedere, Kent might prove helpful in doing so.

1. Fake Punts are the best to use.
2. Don't run with your quarter-back.
3. Always pass the ball at the earliest opportunity.
4. Passing to the left is generally better than to the right.
5. Make sure the ball is thrown in front of the half-back.
6. Don't make long passes as there is probably a member of the opposition further up the pitch.
7. Run along the edges.
8. Try not to pass into the end zone. Try to run the ball in.
9. Run straight ahead and go diagonally when there is someone running in front or behinds you.
10. If you don't do well on your first three downs go for a field goal instead of making a risky throw/run.
11. Field goals have more chance of going in from the 40 yard line.
12. Never go for the punt.
13. In defence use blitzes as often as possible.
14. Use Time-Outs only when you are losing.
15. Use the 4-3 alignment rather than the 6-1.
16. Use the pro-set formation rather than the 'I' formation and the shotgun.

## The Darker Side of Freescape

Liam Hughes of Romford, Essex has strolled through *Dark Side* from Incentive, and here gives us the benefit of his insight into the game.

Start by destroying ECDs 1-5. Now go to the Regulus. Go into the building that is in front of you when you are facing North. In here you will see fuel rods and shield blocks. Collect all of these.

Now destroy ECDs 5-9. This will give you quite a lot of time. Now go through either Umbriel or Procyon. Walk by the prison sensor until you get thrown in prison.

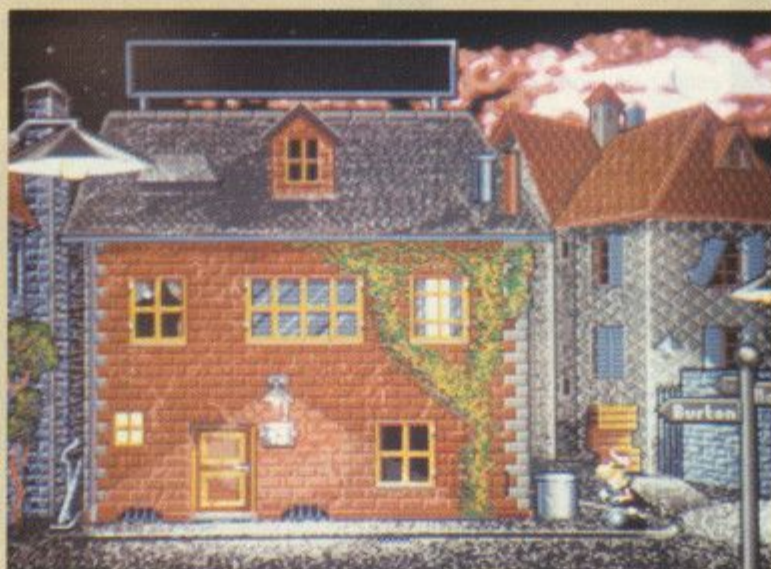

## More C64 Pokes Galore

Never let it be said that ACE ignores C64 owners. After a whole TNT column to themselves in November, C64 fanatics can celebrate the new year with yet more gems. This time they're from Ace hacker and cracker Koen Smedts, Leuven, Belgium. Thanks a million Koen.

**XIS (unlimited lives)**  
POKE 16956,173  
SYS 28672 (to restart)

**LEONARDO (passwords)**  
Moonwalk  
Football  
Blitter

**GEMINI WING (infinite lives)**  
POKE 4518,173  
SYS 4096 (to restart)

**(passwords)**  
Mr.Wimpy (level 2)  
Classics (level 3)  
Whizzkid (level 4)  
Gunshot (level 5)  
Doodguys (level 6)  
D.Gibson (level 7)



**MR. HELI (passwords)**  
CAAHIBEAAMJJJCBKBT  
(LEVEL 2)  
DAAJDFIAAMJJJDBKWCW  
(LEVEL 3)

When inside collect the Telepod Cristal, then get out. You do this by shooting into the boxes, you will either be giving up fuel or shield. Soon the door will open. When you have exited the prison you will be in the tunnels. When you have got out of the tunnels, go and destroy ECDs 9-15.

Now go to Sirius, enter the building in the West. You do this by shooting the block above the door about 10-15 times. When inside Jet-Pac up to the top, here you will see two fuel rods, and two shield blocks, and a Telepod Cristal.

From here go to Iapetus, get into the building East of the river. To do this you have to Jet-Pac over a force field, then get into the building. In it you will find four tele-transporters. Now go and destroy ECDs 15-20. Go to Tethys and collect the four fuel rods.

Now you can get the other (3rd) Telepod Cristal. Destroy ECDs 20-24. Go to Psyche and go into the Telepod and shoot the cristal that takes you to Pollux. Here you will find the final Telepod Cristal. Use this to take you to the NEREIOL sector. Take the letter K, then go back to Psyche, and go

It's simple for Leonardo to do a little Moonwalking, with ACE's recipe for an easy game

**FIRST STRIKE (infinite lives)**  
POKE 38316,173  
SYS 2051 (to restart)

**RICK DANGEROUS**  
POKE 2793,173 (infinite lives)  
POKE 11193,173 (infinite dynamite)  
POKE 10886,173 (infinite bullets)  
SYS 24480 (to restart)



**KING OF THE BEACH (passwords)**  
Sideout (level 2, Chicago)  
Gekko (level 3, Hawaii)  
Topflite (level 4, Rio)  
Sundevil (level 5, Sidney)

**(Try these for other fx)**  
Logic on  
Logic off  
Cheat on  
Cheat off  
Eat me  
Drink me

**(Basic tips)**  
\*always play with sinjohn  
\*smash after the reception  
\*when playing on the left side, set up in the upper corner  
\*on the right side set up in the lower corner  
\*play it a lot!  
\*look at all the girls after 3 rounds!

through the open gate. Destroy the final ECD and the game is complete.

## CPC Capers

Right, C64 owners have had their turn, now its time for some juicy morsels digestible by Amstrad addicts. These tips, once again, come from Liam Hughes of Romford, Essex.

**ROAD RUNNER - KIXX**  
On the selection screen type US for infinite lives.

115



Let me tell you — I'm impressed. When I played Psygnosis' very sexy game, *The Shadow of the Beast*, I thought it was extremely difficult. I certainly wasn't expecting so many cheats, tips, and solutions to be sent in this quickly. Obviously there are plenty of ACE readers out there who can beat anything the Software Houses challenge them with.

Anyway, on with the good stuff. The solution below has been compiled from those sent by Mark Bamber of Preston, Lancashire, and Darren Kevin Peter Matthews (phew!) of Southampton in Hampshire. Both also sent maps of the tree level, and Darren also supplied the map for the castle level.

Follow the arrow left at the start. Punch the boulders and the birds, remembering to jump the grabber

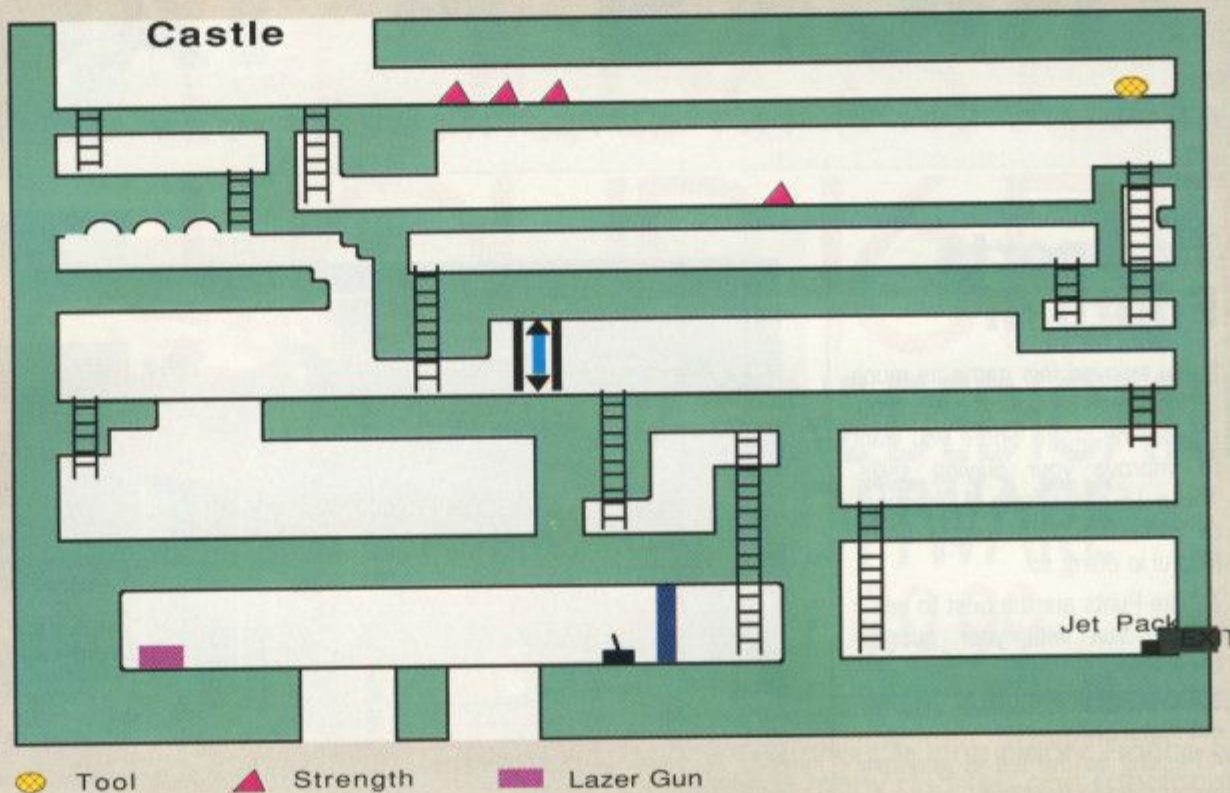

# Beastly Business

(careful, it's difficult to see!). When you reach the door in the tree, enter it.

Once you are inside the tree go right, and jump the fireball that appears from behind you. Now descend the ladder and punch the bee when it reaches the lowest point of its flight. Go down the next ladder and run towards the giant insects. Now crouch and keep doing low punches until they are all destroyed. Now go down a platform, then up to the right, continue going right, then down to the right, and down again until you can not go down any further. Now go left and down, then continue left until you reach a point where acid is dripping from above.

Try to avoid the acid, and continue until some orcs approach you. Run towards them, and as they swing their swords, let them have it.

Once you have finished off the Orcs, you should see the end of the platform. Run and jump just as you are about to fall off the edge. You should now land safely on the opposite ledge, from which you can retrieve the key.

Now step off the platform and fall to the lower ledge. Here you can collect a strength potion which will give you full health. Move right, punching the green snakes as you go. Now climb up the ladder and go to the left. Some more purple orcs will come towards you. Use the same method to kill them as you used before.

Run up to the guardian and crouch when it breathes fire. When it stops breathing, stand up, and punch the ball that it holds once. Now crouch again immediately (or you'll get fried). Repeat this process

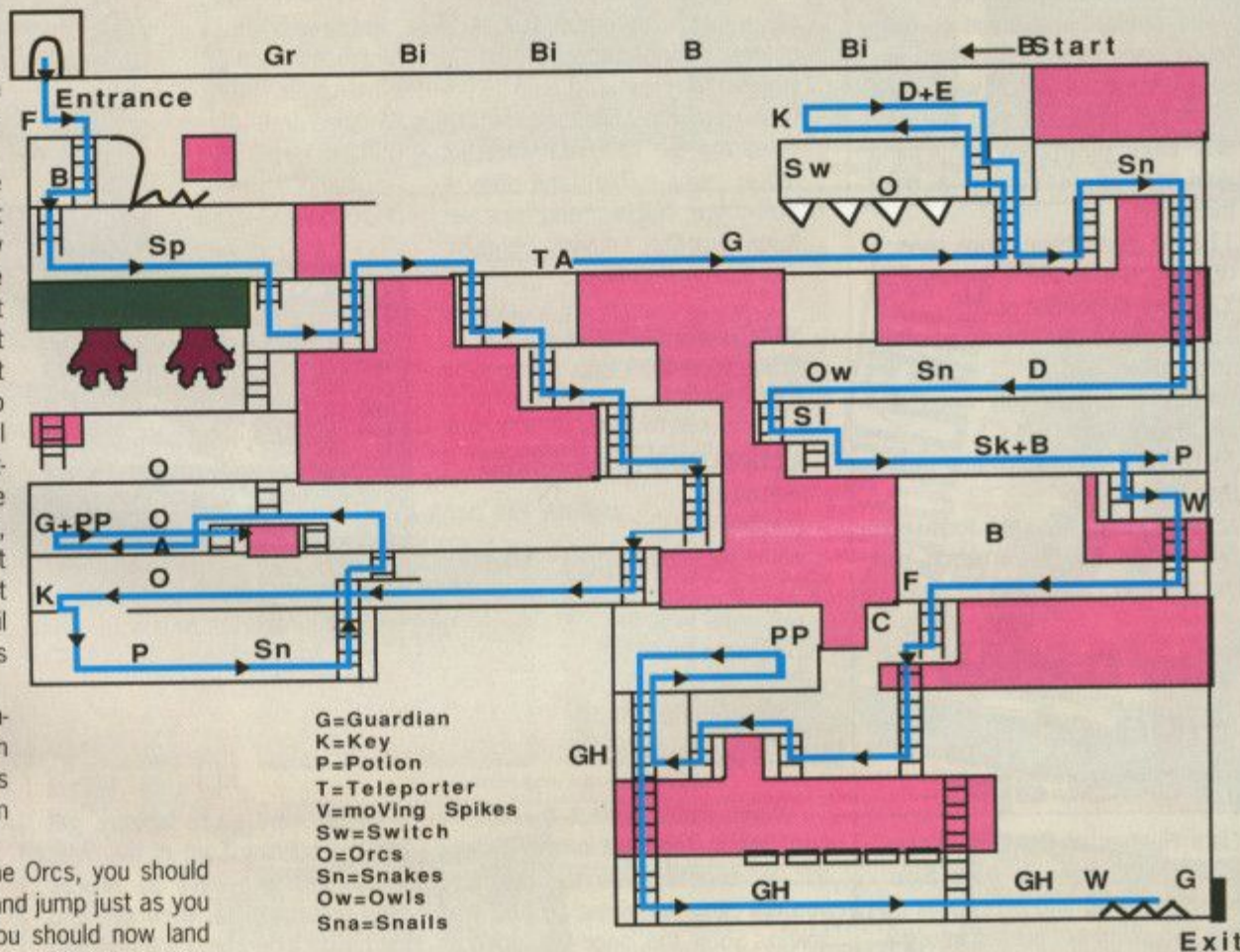

until the ball breaks. You should now shoot light bolts. Walk right and enter the teleporter. You will appear at the position marked on the map as TA. Go right until you meet the next guardian.

Fire the bolts at him until he dies. Don't let him touch you, or you will be squashed. Run right after you have killed him and kill the orcs as before. Try to avoid the spikes (not easy).

Now go up the ladder and up again. Go across to the left, and when the eyes bounce up, run under them one at a time. Stop in between each one, as a

- Gh=Ghosts
- W=Worms
- F=Fireball
- C=Crawler
- A=Acid
- Sp=Spiders
- PP=PowerPunch
- E=Eyes
- W=Flamers
- B=Boulder
- Bi=Bird
- Gr=Grabber
- Ta=Teleporter Appearance
- Sl=Slug
- D=Devils
- Sk=Skulls
- B=Bees



red devil will also come to you. Dispatch this with a punch. When you get to the otherside of the platform, get the key and go back across and down. Now go to the right, and kill the snail, then go right and down the ladder. Blue devils should begin to fall from above. Stand in front of the point at which they fall and punch them. Now jump quickly past the snakes (If you have enough energy left it may be easier to run through them all).

You should now come to some owl heads. When the first of these goes up, run for it and continue running through the devil (unavoidable). Go down to the slug and jump it and then fall down. Continue running and kill the bee as before. Now punch the skulls one by one until you reach another potion which you should collect. Go down the ladder and jump the worm. Continue down and then run along and a large bee will fly above and drop fire bombs. Stand in between the bombs and jump the fireball.

Now move down avoiding the crawler. Go left and kill the ghost, and then go up and collect the power punch which you will take damage from while collecting (unless you have previously pulled the lever which shuts off the electric field around



it). Now go down and right and avoid the thrusters. Continue right until you reach the worms. Get as close to each one as possible, and when it goes, run up to the dragon and crouch, then punch like hell. When it dies, quickly run into the well and climb out into daylight.

At ground level go east punching everything until you get to the castle. Before you go inside, collect the light so you can see. Once inside retrieve the tool then make your way down to collect the laser gun. Now disable the field with the tool in order to proceed, killing the monster and collecting the jet pack.

On level two just blast everything. On the final level punch everything, and kill the giant at the end to finish.

OK, you're saying, that makes it easier, but it's still flippin' difficult. I agree, and so does Greg Stone of Chesterfield, Derbyshire. So to help out those players who are still dying after five minutes' play and long to see more of the great graphics in the game, here is his cheat for infinite energy:

When the loading screen with the picture of the beast appears, press and hold down the fire button on the joystick and the left mouse button, until prompted to insert disk two. Now proceed as normal and you will have infinite energy.

#### AFTER BURNER - ACTIVISION

Levels 1-10 are easy, so try to gain as many bonus lives as possible for later levels. Concentrate on shooting planes down as missiles are easy to dodge.

Levels 11-18 are slightly more difficult, still try to shoot planes down rather than worrying about dodging missiles.

Levels 19-22 are difficult. You will lose some lives. Stop shooting planes and start dodging the missiles. To do this, move up and down. Don't try and pick up any rhythm as the missiles are not fired in a set sequence. If you try to shoot your forward vision will be obscured and you are more likely to get shot down.

On all levels except 8 and 17 go at maximum speed. Levels 5, 13, and 23 are just landing and refuelling except 23 where you have completed the game.

#### OPERATION WOLF - ACTIVISION

Level 1 is simple - just keep your cross-hair in the middle and occasionally move up, and of course down for supplies.

Level 2 is the same as level 1 except you should go up a lot more for the paratroopers. Level 3 is the same as level 1 except that you should not worry about health too much because the villagers will replenish it. Use a grenade when there are too many men.

Level 4 is as level 1 except you do not need to worry about ammo as the ammo factory is your target. Helicopters are a real problem here.

Level 5 is as level 1 except you should shoot permanently at some points.

Level 6 requires you to kill 100 men, so with little time, fire everywhere, and try to use all your grenades over the first half of a level. There are many grenades to pick up.

## Forgotten Worlds

This one comes from Urfan Khan of Coventry, West Midlands, and is a solution to the first three levels.

#### Level 1

Collect as many Zennies (currency) as you can. Blast your way through aliens in a straightforward manner. (Don't try and shoot the first lot of ground based aliens). Go to the shop. Buy everything on sale. Once you are out of the shop, try and kill the spider-like rocket aliens (they inflict most damage). When you're near the end of the level, guide your man through the gate to the demi-

god before they close temporarily. Now guide your man to the bottom right-hand corner as fast as possible and the demi-god will die automatically!

#### Level 2

Kill the lizards and other aliens with your v-cannon. Buy first aid etc. from shop (don't buy multi-directional fire). To avoid giant snakes, stay as close to the top of the screen as possible. To destroy gun-turrets, stay at the bottom of the screen and shoot across (your v-cannon will protect you from their shots). To kill the dust dragon, position your man directly above the dragon's heart and make him face towards the bottom left hand corner, and keep shooting. The dragon will die (your v-cannon will kill the lizards.)

#### Level 3

Kill the aliens in a straightforward manner. Go to the shop. Buy the necessary equipment. (Don't buy laser cannon). When a stair shaped building appears. Guide your man to the bottom right corner, face the top right corner and keep shooting. Once you have reached the top, reposition your man at the bottom of the screen and no shots will touch you.

Once you enter the three gates to the god of war, position your man at the bottom left corner, facing up. The arms of the god will not touch you now.



When you reach the head, move a little to the right and fire up at his shoulder. When it blows up, move to the other side and do the same with the right shoulder until that blows too. Now make your man face to the top left corner and move a little to the left. Now shoot his nose until he dies. All this takes a little practise.

#### Level 4

Sorry, but you're on your own for this one!!









# TINTIN ON THE MOON

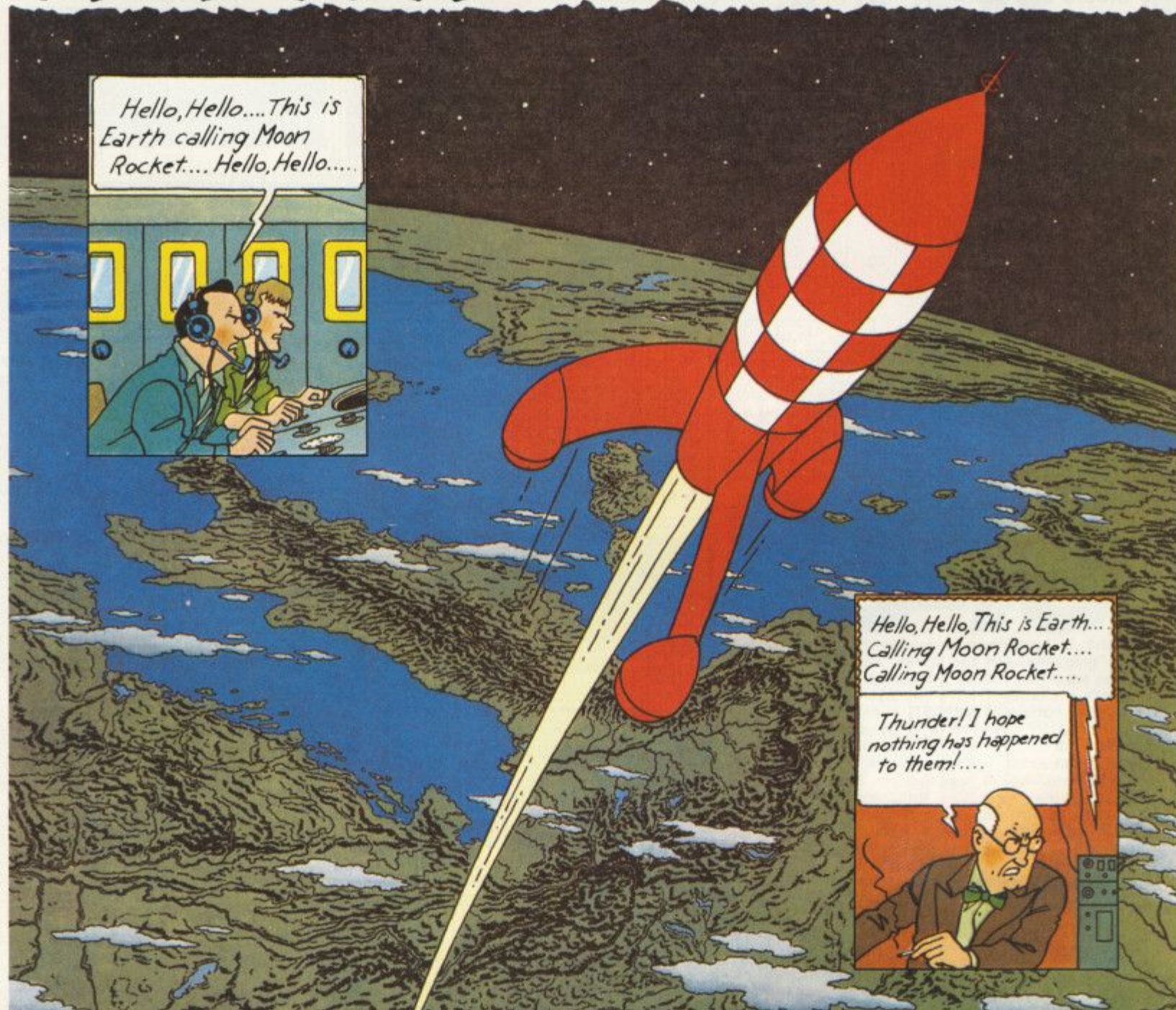

"Hello control station! Here is the moon rocket. Tintin speaking. I have just regained consciousness. Everything seems OK, we are now taking over the controls of the rocket." Aboard the rocket, you will relive with Tintin and his friends the most exciting adventure the world has ever known. The first trip to the Moon!

Will you succeed in piloting the red and white rocket through space and achieve a flawless landing? Will you capture Colonel Boris, the traitor, who wants to make the expedition fail? Will you be able to find the extinguishers to put out the fires, even while floating in zero-gravity (which isn't everybody's idea of fun)? Will you succeed in finding and disarming the bombs and freeing your companions in order to get out of the rocket to make the first step on the Moon? You will discover all this by playing "TINTIN ON THE MOON", the first computer game based on the comic books by Hergé...

Before Armstrong there was Tintin and... may be you!



Available on : **AMIGA, AMSTRAD, ATARI ST, SPECTRUM, C64, IBM PC.**

**INFOGRAMMES** 

Mitre House - Abbey Road - Enfield Middsx - EN2 RQ - Tel. (01) 36.40.123



The console crackin' team are back again. Jojo Cicero and Mark Hook of Cardiff, South Glamorgan are back again with more amazing tips - this time we have the maps for rounds 1- 9 of Spy vs. Spy on the Sega.

round 1



round 2

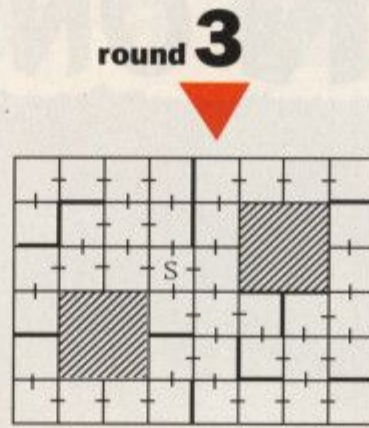

round 3

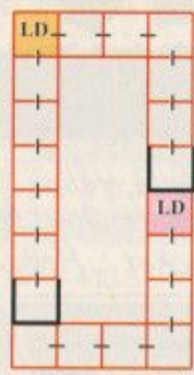

9 round

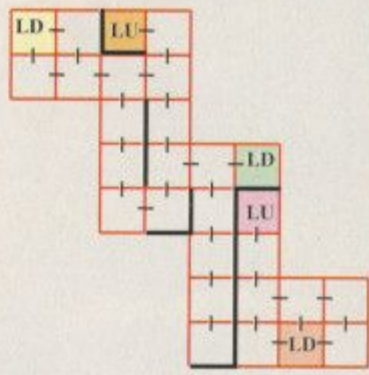

4 round

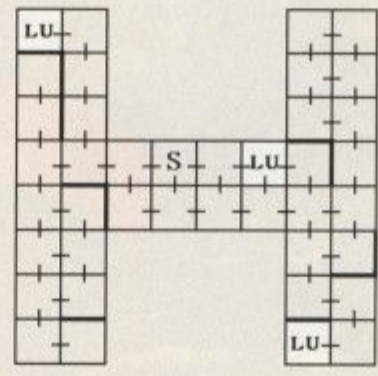
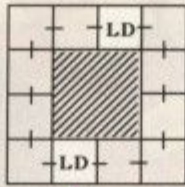
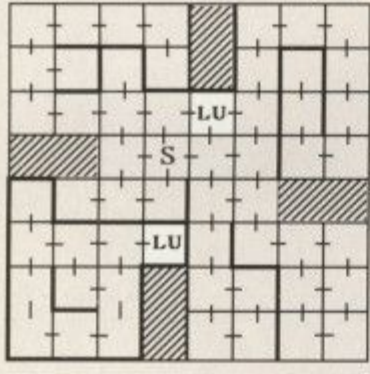

round 5



round 6

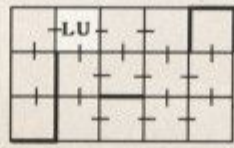
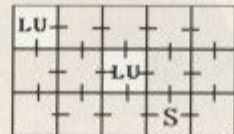
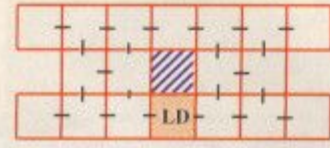
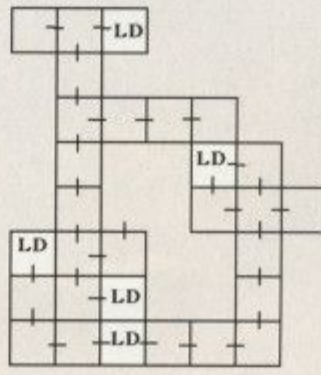
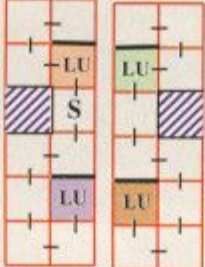
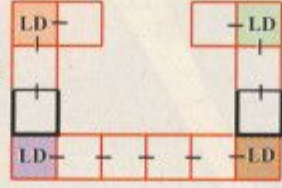

8 round

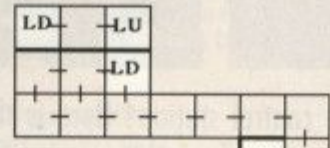

round 7

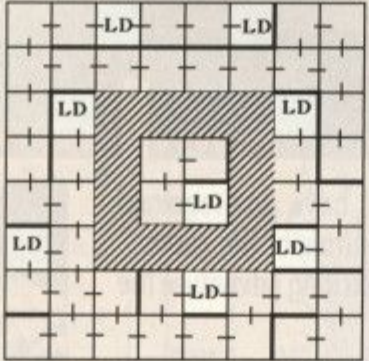

**KEY**

- LU Ladder Up
- LD Ladder Down
- DoorConnection
- S Start

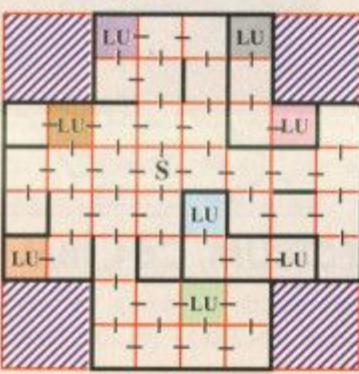
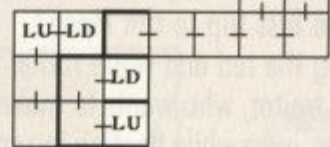

CORNER

CONSOLE





# FREE! TENSTAR PACK WORTH OVER £229!

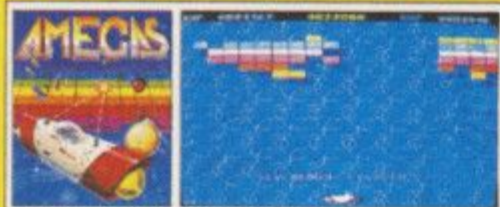

FREE! - AMEGAS - by Players



FREE! - INSANITY FIGHT - by Microdeal



FREE! - ART OF CHESS - by SPA



FREE! - MERCENARY COMP - by Novagen



FREE! - BARBARIAN, ULT WARRIOR - by Palace



FREE! - TERRORPODS - by Psygnosis



FREE! - BUGGY BOY - by Elite



FREE! - THUNDERCATS - by Elite



FREE! - IKARI WARRIORS - by Elite



FREE! - WIZBALL - by Ocean

# Commodore AMIGA



ONLY £3.34 PER WEEK  
RETURN COUPON FOR DETAILS

# £346.95

+VAT= £399  
INCLUDES FREE UK DELIVERY

The Amiga 500 is one of a new breed of technologically advanced computers, which are now emerging as the new standard for home computing, based around the new Motorola 68000 chip. The A500 has 512K RAM and a 1Mbyte double sided disk drive built-in. It can be connected directly to a wide range of monitors, or to a domestic TV set through a TV modulator. Designed with the user in mind, the A500 features a user friendly WIMP environment and comes supplied with a free mouse. And, when you buy your Amiga from Silica Shop, the UK's No1 Amiga specialists, you will experience an after sales service that is second to none, including a technical support helpline and free newsletters and price lists. Return the coupon below for our current information pack, which will give details of the Silica service and the very latest Silica Amiga offers. E&OE

## WHY SILICA SHOP?

Before you decide when to buy your new Commodore Amiga computer, we suggest you consider very carefully WHERE you buy it. There are MANY companies who can offer you a computer, a few peripherals and the top ten selling titles. There are FEWER companies who can offer a wide range of products for your computer as well as expert advice and help when you need it. There is ONLY ONE company who can provide the largest range of Amiga related products in the UK, a full time Amiga specialist technical helpline and in-depth after sales support, including free newsletters and brochures delivered to your door for as long as you require after you purchase your computer. That one company is Silica Shop. We have been established in the home computer field for ten years and can now claim to meet our customers requirements with an accuracy and understanding which is second to none. Here are just some of the things we can offer you.

**THE FULL STOCK RANGE:** The largest range of Amiga related peripherals, accessories, books and software in the UK.

**AFTER SALES SUPPORT:** The staff at Silica Shop are dedicated to help you to get the best from your Amiga.

**FREE NEWSLETTERS:** Mailed direct to your home as soon as we print them, featuring offers and latest releases.

**FREE OVERNIGHT DELIVERY:** On all hardware orders shipped to Silica Shop customers within the UK mainland.

**PRICE MATCH PROMISE:** We will normally match our competitors offers on a 'same product same price' basis.

**FREE TECHNICAL HELPLINE:** Full time team of Amiga technical experts to help you with your technical queries.

But don't just take our word for it. Complete and return the coupon below for our latest Amiga literature and begin to experience the Silica Shop specialist Amiga service.

## PHOTON PAINT PACK

A500 Computer	£399.99
TV Modulator	£24.99
Photon Paint	£69.95
TenStar Pack	£229.50
<b>TOTAL RRP:</b>	<b>£724.43</b>
<b>LESS DISCOUNT:</b>	<b>£325.43</b>
<b>PACK PRICE INC VAT:</b>	<b>£399</b>

## 1084S MONITOR PACK

A500 Computer	£399.99
1084S Colour Monitor	£299.99
Photon Paint	£69.95
TenStar Pack	£229.50
<b>TOTAL RRP:</b>	<b>£999.43</b>
<b>LESS DISCOUNT:</b>	<b>£350.43</b>
<b>PACK PRICE INC VAT:</b>	<b>£649</b>

## FREE FROM SILICA

When you buy the Amiga 500 from Silica Shop, you will not only get a high power, value for money computer, we will also give you some spectacular free gifts. First of all, we are now including a TV modulator with every A500 stand alone keyboard, so you can plug your Amiga straight into your TV at home (the modulator is not included with the A500-A1084S pack as it is not required for use with monitors). Secondly, we have added a free copy of Photon Paint, an advanced graphics package with an RRP of £69.95. Last (and by no means least!), so that you can be up and running straight away, we are giving away the sensational TENSTAR GAMES PACK with every A500 purchased at Silica Shop. This pack features ten top Amiga titles which have a combined RRP of nearly £230! Return the coupon for details.

## FREE TENSTAR PACK

Amegas	£14.95
Art Of Chess	£24.95
Barbarian, Ult Warrior	£19.95
Buggy Boy	£24.95
Ikari Warriors	£24.95
Insanity Fight	£24.95
Mercenary Comp	£19.95
Terrorpods	£24.95
Thundercats	£24.95
Wizball	£24.95
<b>TOTAL RRP:</b>	<b>£229.50</b>

**TOTAL RRP: £229.50 INC VAT**

## DO YOU OWN AN AMIGA?

If you already own an Amiga computer and would like to be registered on our mailing list as an Amiga user, let us know. We will be pleased to send you copies of our price lists and newsletters FREE OF CHARGE as they become available. Complete the coupon and return it to our Sidcup branch and begin experiencing a specialist Amiga service that is second to none.

## SILICA SHOP:

<b>SIDCUP (&amp; Mail Order)</b>	<b>01-309 1111</b>
1-4 The Mews, Hatherley Road, Sidcup, Kent, DA14 4DX	
OPEN: MON-SAT 9am - 5.30pm LATE NIGHT: FRIDAY 9am - 7pm	
<b>LONDON</b>	<b>01-580 4000</b>
52 Tottenham Court Road, London, W1P 0BA	
OPEN: MON-SAT 9.30am - 6.00pm LATE NIGHT: NONE	
<b>LONDON</b>	<b>01-629 1234 ext 3914</b>
Selfridges (1st floor), Oxford Street, London, W1A 1AB	
OPEN: MON-SAT 9am - 6.00pm LATE NIGHT: THURSDAY 9am - 8pm	

To: Silica Ltd, Dept ACE 1189, 1 - 4 The Mews, Hatherley Road, Sidcup, Kent DA14 4DX.  
**PLEASE SEND ME FREE LITERATURE ON THE AMIGA**

Mr/Mrs/Ms: Initials: Surname:

Address:

Postcode:

Do you already own a computer  
If so, which one do you own?



# BATTLETECHnology

ACE reveals the story, specs and sensation of 31st Century gaming...



Each cockpit is equipped with a 25" colour monitor, which serves as a front window to the vehicle and displays graphics of the surrounding environment and the ensuing battle. The secondary screen is used for radar and vehicle status. Dual joysticks with trigger buttons, weapon selection displays, throttle control, directional pedals, ceiling message centre, radio controls for communication with team-mates and attendant and other interior battle functions all add to the realism of the battle

Imagine not only playing a computer game but actually experiencing it: that's the underlying ideal behind ESP Corporation's BattleTech Centre – a simulation experience far more advanced than any other system available to the general public and one of the most exciting games prospects to hit the market in years.

Jordan Weisman, designer of BattleTech Centre and founder of ESP Corporation, told ACE: "We have created a whole new entertainment medium – the world's first complete computer simulation experience for play".

## INTERACTIVE STAR WARS

Weisman, a 29 year-old dyslexic, originally had the concept for BattleTech Centre ten years ago. The central idea behind BattleTech Centre was to bring the movie magic made popular by Star Wars to a place where people could actually participate in the total environment of a fantasy world. So Weisman and friend L. Ross Babcock III formed FASA in 1980, with the hope of raising funds to produce the Environmental Simulation Project – but they were greeted with scepticism from potential investors worried about the high risk factor and costs.

Instead, FASA concentrated on creating immensely popular adventure and role-playing board games such as BattleTech, Renegade Legion and Star Trek. Prompted by this success Weisman decided to revive the BattleTech Centre concept and started FASA's sister company, ESP Corporation – dedicated to interactive entertainment.

BattleTech Centre takes advantage of cheaper microcomputer technologies: "this gives us the speed and graphic power required without having to

## BattleTech cockpit controls

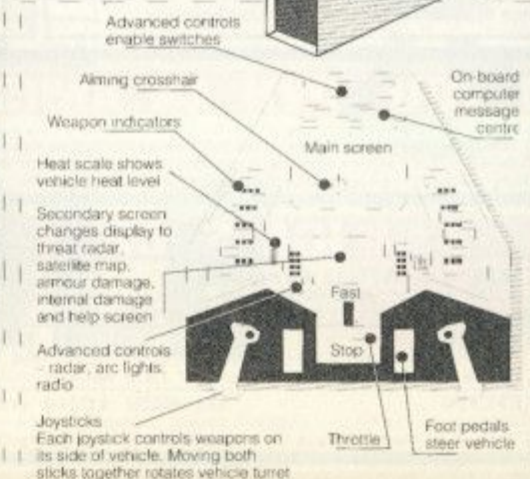



### BattleTech Specs

Each BattleTech Centre cockpit contains 32Mb of RAM and 26 proprietary PC boards, which make up the graphics, sound and cockpit control systems. The computers communicate with the other cockpits via a local area network. The cockpits main screen can display 200 3D objects in real-time, using a maximum of 64000 colours on screen at any one time.

The game's visuals are split between two viewing screens: the primary "out the front window" screen and a secondary screen used for radar and other information. ESP designed the primary screen graphic system differently than most military type simulators, which model the on-screen universe via a set of polygons requiring incredibly fast maths processors to handle the calculations involved. Instead, BattleTech Centre graphics systems use 19000 pre-drawn "arted" images which were originally created on a CAD system and rendered using ray-tracing, shading, source lighting and edge smoothing. The graphics systems also use a fast and versatile geometry engine which performs hardware scaling of the images in real-time and allows 2D transformations such as mirroring, warping, flips and keystoneing.

### Primary screen:

Graphics processor	34010 at 40MHz
Theoretical through-put	400 nanoseconds per pixel
Practical through-put	200 "arted" images in real-time
Screen resolution	320x200
Maximum colours on-screen	64000
Total colour palette	16 million colours
System memory	34.5Mb of RAM, expandable to 130.5Mb
Graphic images in memory	19000
Special geometry engine	Hardware scaling of graphic images and performs 2D transformations.

### Secondary screen:

Game and graphics processor	68010 at 7MHz
Screen resolution	320x200
Colours per screen	16
Total colour palette	4096

### Sound system:

Processor	6809
Digital samplers	ADPCM and PCM format
Channels	20
Watts per channel	63
Memory	420K RAM

The sound system incorporates three sound generation devices, giving it the ability to generate spatially orientated sounds from either straight sampled sounds, sampled sounds with frequency control or FM synthesised sounds.

### Cockpit controls:

- 2 Eight position joysticks, each containing three firing buttons
  - 1 Analog throttle
  - 2 Analog foot pedals
  - 52 Momentary switches
  - 8 Momentary rocker switches
  - 116 button keypad
  - 132 segment LCD bar-graph
  - 128 4 segment LED alpha-numeric display
- Each cockpit has close to a hundred controls and over a hundred indicator lights.



**As each object is placed on screen, it's assigned a colour palette which consists of 256 colours. Palettes are assigned based on the object type, location and situation. An example of this palette use is distance haze. In the real world, as an object gets farther away it tends to blend into the background - the palette system mimics this perfectly**



**BattleTech Centre uses a new series of Mechs to be introduced to role-players over the next six months. This particular Omni-Mech serves mostly in a fire-support role.**



use a huge multi-million mainframe computer," says Mike Hanson, director of BattleTech Centre system development at Incredible Technologies. Weisman adds, "In the past only governments could afford this sort of thing. ESP has found a way to bring the person on the street the same sophisticated imaging of commercial and military flight simulations used by NASA and the Air Force".

### PLAY THE GAME

The BattleTech Centre is an environmental complex which simulates a fictional universe, the core experience being an eight-player battle. Each player sits in an enclosed cockpit, whose simulator allows each contestant to see a graphic image of the other player's vehicle, their movements and the surrounding terrain. The BattleTech Centre operates in a 5000 square foot location, encompassing a lobby area, two combat information systems, embarkation hall and two launch areas.

The lobby area is decorated as a wardroom of a giant starship with 10-12 video monitors broadcasting fictitious newscasts from the future, cockpit simulator instructions and "God's Eye View" of games in progress. This, coupled with uniformed staff, surrounds players with sensory cues of a science fiction universe. In the Combat Information Centres, a uniformed officer hands players their sheet of orders and

they are allowed to form team strategies, scope the terrain of their mission and obtain information on the universe via a "user friendly" computer. The launch areas are dominated by eight cockpits (each 10 feet by 3.5 feet by 5 feet).

The simulators are connected via computer network to produce a real-time simulation experience in an interactive, 3D environment. The terrain, vehicles and mission change every game, so each time you play there are new challenges. In addition, for the first time, the opponent you face is not a computer, but another player who thinks ahead, learns from their mistakes, and is unpredictable.

Each BattleTech Centre will have two eight-player games going on simultaneously. The Centre can change its fictional environment every 30 minutes.

The game software and videos are changed and the result is a new universe and vehicle type to master. The first two environments created for BattleTech Centres are based on FASA's BattleTech and Renegade Legion role-playing games. BattleTech is set in the year 3050, where the masters of the battlefield are huge, manlike BattleMech droids. Renegade Legion is a game of starfighter combat in the year 6000. ESP will create several other environments in the future.

The BattleTech Centre books reservations for teams, or mix and match individuals as they arrive to make up teams for each game sequence. A half-hour experience will be priced on a par with a trip to the cinema or squash-court.

### COMING TO A TOWN NEAR YOU?

ESP plans to develop 150 BattleTech Centres across the United States and Canada, and has a license for distribution in Japan. Each complex will cost approximately \$750000 to build - \$500K for the electronics package and \$100-\$250K construction cost. The first BattleTech Centre was scheduled to open in Chicago before Christmas, but has been delayed until March 1990 due to leasing problems. Weisman enthuses, "sites in Las Vegas and Los Angeles are under negotiation. We're also in-touch with major UK arcade companies and theme-park organisers - we hope to have a deal signed soon..."



# BEVERLY HILLS

® & © 1990 PARAMOUNT PICTURES.  
ALL RIGHTS RESERVED.

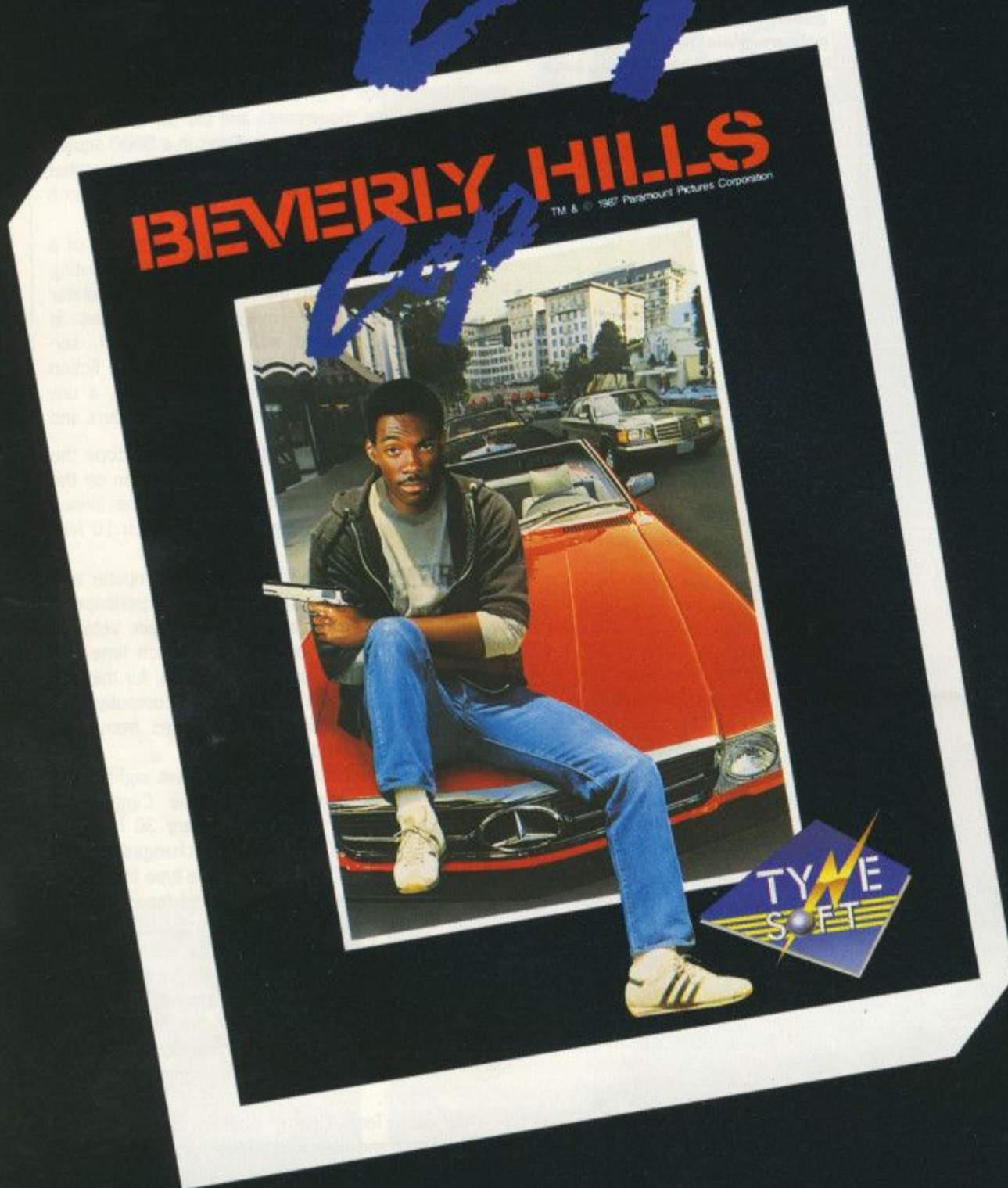

Look out, Beverly Hills  
Here comes Axel Foley !

The hero of "Beverly Hills Cop" and "Beverly Hills Cop II" is back in Beverly Hills - and this time he's working on a case that's a real stumper! He's going to stop the crime of the year, unless an army of trigger-happy gunmen stop him first !

You'll roar down crowded city streets, race against time to stop a daring robbery, stalk armed killers, hunt for clues to a bizarre crime, and fight for your life again and again in this high-speed action adventure starring the fast-talking, quick-shooting detective.

#### AVAILABLE ON:

ST £24.99 AMIGA £24.99 PC £24.99 CBM64 CASS £9.99  
CBM64 DISK £14.99 AMSTRAD CASS £9.99 AMSTRAD DISK £14.99  
SPECTRUM CASS £8.99 SPECTRUM DISK £14.99





# UPDATES

A ROUND UP OF THE LATEST MAJOR CONVERSIONS

## PICTIONARY

### The latest versions - ST, Spectrum, Amstrad

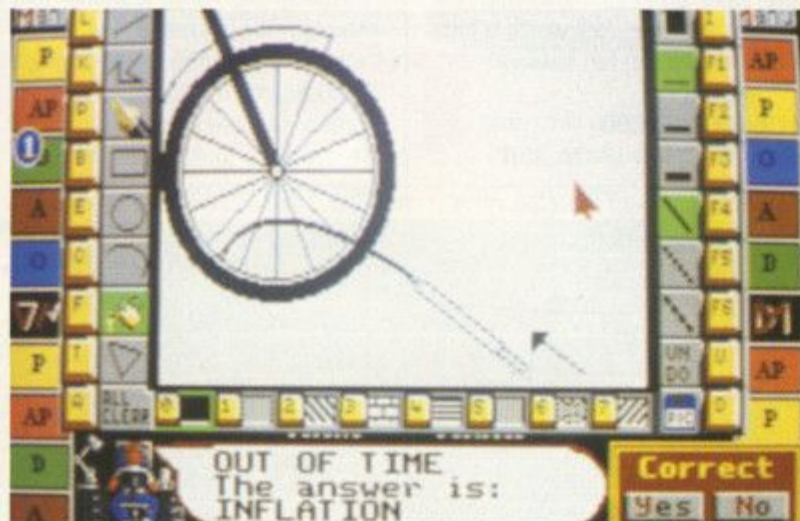

Pictionary on the ST

Domark; Amiga Version reviewed Issue 26; ACE Rating 790

Having managed to capture the license for the most popular board game of all time (*Trivial Pursuit* — for those who've been living in a cupboard for the last five years), Domark have now turned their attentions to the lat-

est Yuppie board game — *Pictionary*. The idea behind this one is that one member of a team draws a picture and the other players have to guess the word that the picture is intended to convey within a set time limit. Guessing the word correctly allows you to move your counter further round the board.



Pictionary on the Amstrad

### ST VERSION

£24.99dk

The first thing that struck me about this version was how well the drawing utility actually stands up in its own right. All of the functions are particularly easy to access (just a single key press for each), and there are enough of them to produce some quite intricate doodles. The arc tool is particularly useful and powerful. As an added bonus, once you have completed a picture you can save it in Neochrome format (it is then a fairly simple matter to import it into most commercial ST art software).

I'm not convinced that paying £25 for *Pictionary* on the ST is preferable to buying the original board game. However, the ST and other versions do have the additional appeal of being able to assign all the picture drawing to the computer (essential if you're playing solo).

● ACE RATING 750

### SPECTRUM VERSION

£19.99dk £14.99cs

The first thing I expected to find on loading up this version was an inferior doodle package, so I was pleasantly surprised to find that this was not the case. All of the functions available are easily accessed with either the pointer or a single key press. The disadvantage of this and other 8-bit versions is the lack of a mouse for drawing. I tried playing with the keyboard controls, and to be quite honest, drawing anything other

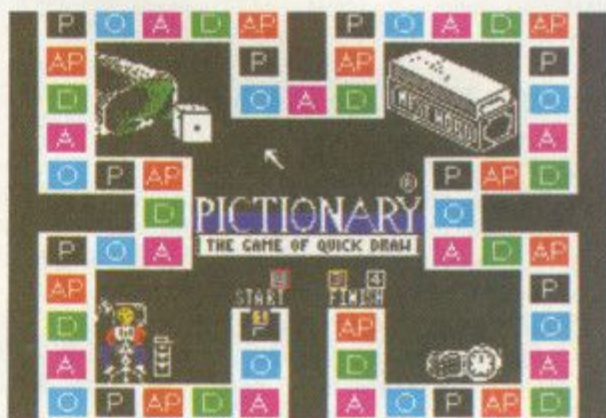

Pictionary on the Spectrum

than very simple shapes proved to be a long-winded and painful process. It is still quite fun to play with the computer drawing the piccies, although if you have the cassette version be prepared to wait during the frequent tape loads as the next block of piccies is got into memory.

● ACE RATING 550

### AMSTRAD VERSION

£19.99dk £14.99cs

The presentation here is slightly better than on the Spectrum version, although the sound is still limited to a twangy title tune and the occasional blip when you select a function. There are still the same difficulties with drawing without a mouse, although it is a little easier if you use a joystick. Again, not a bad effort, but both this and the other 8-bit versions are a little overpriced.

● ACE RATING 600





Fiendish Freddy on the ST

## ATARI ST

### FIENDISH FREDDY'S BIG TOP 'O FUN

Mindscape; £29.99; Amiga Version reviewed Issue 24; ACE Rating 775

*Fiendish Freddy* is one of those games that really shows off the capabilities of the Amiga. It had great sound, bold cartoon style graphics, and bags of humour. It was also the sort of game that could well have lost all its appeal once it had been converted to the ST. Happily that is not the case. Everything that made this game

enough to earn enough money to pay off the loan. These are High Diving, Juggling, Trapeze Swinging, Knife Throwing, Tightrope Walking, and Human Cannonball.

Each of the events is quite difficult to master, but matters are made worse by the presence of *Fiendish Freddy* himself — an evil little clown who is determined to sabotage every single event.

The whole thing is a lot of fun to play, and the large humorous sprites should keep you entertained for some time. Shame about the tedious disc swapping though.

ACE RATING 725



Continental Circus on the ST

appealing on the Amiga has been packed into the ST version. Packed is, perhaps, the wrong word to use. The whole thing sprawls over no less than six disks. A fact which is not made any more delightful by the necessity for frequently swapping the disc that is currently in the drive.

The idea behind *Fiendish Freddy* is that the bank are about to foreclose on you and make your circus bankrupt, so unless you can come up with the cash within 24 hours all will be lost. The way you manage this is by performing six circus acts well

### CONTINENTAL CIRCUS

VIRGIN/MASTERTRONIC; £19.99dk; Amiga Version reviewed Issue 26; ACE Rating 875

Virgin's 2D version of Taito's unusual 3D arcade racing game has now made it to the ST. *Continental Circus* was not the most amazing arcade game of 1989 but it did have the virtue of being extremely playable. The Amiga version was a superb conversion from the dedicated machine, and

as far as I can tell the ST version is identical in almost every respect. I say 'almost' because the ST's inferior sound chip has reared its ugly head again and fouled things up for the *Circus* programmers. Actually it's not all that bad — your engine just goes suddenly silent as opposing cars whizz past.

That's a minor quibble though — the game is otherwise excellent. There are some interesting aspects to this game which gives it a slight edge over other similar offerings. If you crash, for instance, your car is damaged but not completely written off, so you still have time to crawl into the pits for a repair. Well worth a look if you're a racing fan.

ACE RATING 850

vent the puck from getting into the opposing goal. If you knock in three against the computer (or against your opponent) you can progress to the next level. Hazards line the floor such as magnetic forces and walls which hinder the journey of the puck. There are around 50 pitches in the one player mode and about 80 in the two player. You can adjust the flow of the game by changing parameters like gravity pulls and shooting. There are tokens in the forms of boxes that give you things like exploding balls and letters that spell out "RICOCHET".

The EGA graphics don't stretch to the PC to its limit, and although the screens that were breathtaking on the ST and Amiga are included, they fail to impress. Sprites and background graphics are pretty to look at but can, as I mentioned before, clutter up the



Battlestix on the PC

## PC

### BALLISTIX

Psyclipse; £24.95dk; Amiga version reviewed Issue 20; ACE Rating 686

Psygnosis are the sort of company who can take an old, simple idea, chuck in some pretty nifty graphics and some amazing sounds, then bring out a game good enough to be mistaken for an arcade original. The idea for this one apparently comes from *Crossfire*, but I doubt if many can remember it, I certainly can't. The idea is to shoot balls at the puck and to knock it into the opposing goal.

You can play against a friend or the computer. You've got an infinite number of balls, but each ball only lasts for a couple of seconds. The screen can sometimes get cluttered up the with an array of balls. The computer doesn't control the other player, but sets a gravity boundary which can pre-

screen. The sound is a bit irritating — enough to give you a headache. The game doesn't really present any challenge, and is far from addictive. *Ballistix* on the PC is similar to the other 16 bit versions, even down to start-up sequences, but alas, it doesn't quite make the grade.

ACE RATING 589

## UPDATES CRAZY!

Starting in issue 30, we'll be running a new updates section in ACE, covering more machines, more games, and giving more detail.

If you've got any suggestions for the new section, let us know at ACE Updates, 30-32 Farringdon Lane, London, EC1R 3AU.



# 520ST-FM SUPER PACK



**1Mb DISK DRIVE  
£450 OF SOFTWARE**

### ARCADE GAMES

Arkanoid II	Imagine	£19.95
Beyond The Ice Palace	Elite	£19.95
Black Lamp	Firebird	£19.95
Buggy Boy	Elite	£19.95
Chopper X	Mastertronic	£9.99
Ikari Warriors	Elite	£14.95
Marble Madness	Electronic Arts	£24.95
Quadralien	Logotron	£19.95
Ranarama	Hewson Consultants	£19.95
Return To Genesis	Firebird	£19.95
Roadwars	Melbourne House	£19.95
Starquake	Mandarin	£19.95
Test Drive	Electronic Arts	£24.95
Thrust	Firebird	£9.95
Thundercats	Elite	£19.95
Wizball	Ocean	£19.95
Xenon	Melbourne House	£19.95
Zynaps	Hewson Consultants	£19.99

### SPORTS SIMULATIONS

Eddie Edwards Super Ski	Elite	£19.95
Seconds Out	Tynesoft	£19.95
Summer Olympiad '88	Tynesoft	£19.95

### PRODUCTIVITY SOFTWARE

Organiser	Triangle Publishing	£49.95
-----------	---------------------	--------

### JOYSTICK

Atari CX40 Joystick	Atari Corp	£4.99
---------------------	------------	-------

**FREE ATARI BUNDLE VALUE: £458.97**

The Atari Super Pack is ideal for you if you want to get off to a flying start with the best in entertainment software. The Pack includes a 520ST-FM with 1Mb RAM, a built-in 1Mb disk drive, over £450 of top games and a joystick. If you buy the Super Pack at Silica Shop, we will add our own ST Starter Kit (worth over £200). Free Of Charge. Return the coupon for details.

# £399

INCLUDING VAT

With SM124 mono monitor: £498 INC VAT

With SC1224 colour monitor: £698 INC VAT

# 1040ST-FM PROFESSIONAL PACK

## NOW WITH TV MODULATOR

For the serious home user and the small business, we are pleased to announce a new package based around the 1040ST-FM. The 1040ST-FM has 1Mbyte RAM and a 1Mbyte built-in disk drive. In addition, the 1040ST-FM now comes with a TV modulator built-in. (The previously available 1040ST-F was designed for use with a monitor only and did not come with a modulator.) This modulator allows the 1040ST-F to be plugged directly into any domestic TV set, and comes complete with a lead to allow you to do so. The new 'Professional Pack' from Silica includes the new 1040ST-FM with modulator plus four high quality software packages including a spreadsheet, database, word processor and programming language. This 'Professional Pack' software will enable you to get straight down to business with your new computer. In addition to this software (worth £384.84), if you buy the Professional Pack from Silica Shop, you will also receive the Silica ST Starter Kit (worth over £200). Free Of Charge. Return the coupon for further information.



# £499

INCLUDING VAT

With SM124 mono monitor: £598 INC VAT

With SC1224 colour monitor: £798 INC VAT

ATARI 1040ST-FM	(Computer)	£499.99
VIP PROFESSIONAL	(Spreadsheet)	£149.95
MICROSOFT WRITE	(Word Processor)	£149.95
SUPERBASE PERSONAL	(Database)	£59.95
BASIC DISK & MANUAL	(Language)	£24.98

NORMAL RRP: £884.82

LESS DISCOUNT: -£385.82

PROFESSIONAL PACK PRICE: £499.00

# 2Mb & 4Mb MEGA ST

The MEGA ST computers are styled as lightweight keyboard with a separate CPU, connected by a coiled telephone style cable. There are two versions of the MEGA ST, one with 2Mbytes of RAM and the other with 4Mbytes. Each version has a 1Mbyte double sided disk drive built-in to the CPU unit. The MEGA ST's do not come with modulator built-in and must therefore be used with a monitor. With every MEGA ST purchased, we will add the 'Professional Pack' software (worth £384.83) detailed above, plus the Silica ST Starter Kit (worth over £200) both Free Of Charge. Return the coupon for further details.

**2Mb MEGA ST**  
**£899** INC VAT

+ mono monitor = £998

+ colour monitor = £1198

**4Mb MEGA ST**  
**£1199** INC VAT

+ mono monitor = £1298

+ colour monitor = £1498



# DTP PageStream £149 +VAT = £171.35

Desktop Publishing (DTP) is one of the fastest growing applications for personal computers. We are pleased to announce a powerful low cost package for the Atari ST called PageStream. PageStream costs only £149 (+VAT = £171.35) and, because it works with an Atari 1040ST and a Seiko/Sharp SP-180A printer, you can be up and running with a complete system for less than £1000. Some of the features of PageStream are listed to the right. If you would like further information on this program, complete and return the coupon below, ticking the 'DTP' box in the corner.

- \* TEXT-FLOW AROUND GRAPHICS
- \* ROTATION OF TEXT & GRAPHICS
- \* SLANT OR TWIST ANY OBJECT
- \* POSTSCRIPT COMPATIBLE
- \* TAG FUNCTION
- \* AUTO/MANUAL KERNING & HYPHENATION
- \* GROUPING OF OBJECTS



# ST COMPUTERS

The range of Atari ST computers offers something for everyone. From the games enthusiast who wants the challenge of the very best in arcade action, to the businessman who wants to make financial forecasts or faultless presentations. The ST offers high quality graphics, sound and speed for the gamer, whilst providing a fast, user friendly and affordable solution to business. The ST is now firmly established in the home environment and boasts a wealth of users in education, local government, television, and a variety of different businesses. Software for the range stretches to cover applications as diverse as ENTERTAINMENT, ACCOUNTS, ART, COMMUNICATIONS, COMPUTER AIDED DESIGN, DATABASES, DESKTOP PUBLISHING, EDUCATION, MUSIC, PROGRAMMING, SPREADSHEETS, WORD PROCESSING and more. For a full list of the software available, as well as details of the ST range, complete and return the coupon below.

All prices correct at the time of going to press. E.A.C.E.

# 520ST-FM EXPLORER PACK WITH BUILT-IN 1Mb DISK DRIVE



The value for money offered by the Atari ST range is reflected in the Explorer Pack featuring the 520ST-FM computer with 512K RAM. The 520ST-FM computer now comes with a built-in 1 Mb double sided disk drive as well as a free mouse controller and a built-in TV modulator. The new 520ST-FM Explorer Pack includes the 520ST-FM computer, the arcade game Ranarama, a tutorial program and some useful desktop accessories. In addition, if you buy the Explorer Pack from Silica, we will give you the Silica ST Starter Kit worth over £200, FREE OF CHARGE. Return the coupon for details of our Starter Kit and of the full ST range.

# £260

ONLY **£2.51** PER WEEK  
RETURN COUPON FOR DETAILS

+ VAT = **£299**

+ SM124 mono monitor: £398 INC VAT

+ SC1224 colour monitor: £598 INC VAT

# WHY SILICA SHOP?

Before you decide when to buy your new Atari ST computer, we suggest you consider very carefully WHERE you buy it. There are MANY companies who can offer you a computer, a few peripherals and the top ten selling titles. There are FEWER companies who can offer a wide range of products for your computer and expert advice and help when you need it. There is ONLY ONE company who can provide the largest range of Atari ST related products in the UK, a full time Atari ST specialist technical helpline and in-depth after sales support, including free newsletters and brochures delivered to your door for as long as you require after you purchase your computer. That one company is Silica Shop. We have been established in the home computer field for ten years with an annual turnover in excess of £8 million and can now claim to meet our customers requirements with an accuracy and understanding which is second to none. But don't just take our word for it. Complete and return the coupon below for our latest literature and begin to experience the Silica Shop specialist Atari service.

**SILICA STARTER KIT:** Worth over £200. FREE with every Atari ST computer bought from Silica.

**PROFESSIONAL PACK:** Free business software with 1040ST-FM and MEGA ST's bought from Silica.

**DEDICATED SERVICING:** 7 full-time Atari trained staff with years of experience on Atari servicing.

**THE FULL STOCK RANGE:** All of your Atari requirements from one place.

**AFTER SALES SUPPORT:** The staff at Silica are dedicated to help you get the best from your ST.

**FREE CATALOGUES:** Mailed direct to your home as soon as we print them, featuring offers as well as all of the new releases.

**FREE OVERNIGHT DELIVERY:** On all hardware orders shipped within the UK mainland.

**PRICE MATCH PROMISE:** We will match competitors on a 'same product same price' basis.

**FREE TECHNICAL HELPLINE:** Full time team of Atari technical experts always at your service.

# FREE SILICA STARTER KIT WORTH OVER £200

WITH EVERY ST - RETURN COUPON FOR DETAILS  
ALL PRICES QUOTED INCLUDE FREE UK DELIVERY

# DO YOU OWN AN ATARI ST?

If you already own an Atari ST computer and would like to be registered on our mailing list as an ST user, let us know. We will be pleased to send you copies of our price lists and newsletters FREE OF CHARGE as they become available. Complete the coupon and return it to our Sidcup branch and begin experiencing a specialist ST service that is second to none.

## SILICA SHOP:

**SIDCUP (& Mail Order) 01-309 1111**

1-4 The Mews, Hatherley Road, Sidcup, Kent, DA14 4DX

OPEN: MON-SAT 9am - 5.30pm LATE NIGHT: FRIDAY 9am - 7pm

**LONDON 01-580 4000**

52 Tottenham Court Road, London, W1P 0BA

OPEN: MON-SAT 9.30am - 6.00pm LATE NIGHT: NONE

**LONDON 01-629 1234 ext 3914**

Selfridges (1st floor), Oxford Street, London, W1A 1AB

OPEN: MON-SAT 9am - 6.00pm LATE NIGHT: THURSDAY 9am - 8pm

To: Silica Ltd, Dept ACE 1189, 1 - 4 The Mews, Hatherley Road, Sidcup, Kent DA14 4DX.

**PLEASE SEND FREE LITERATURE ON THE ATARI ST**

Mr/Mrs/Ms: ..... Initials: ..... Surname: .....

Address: .....

Postcode: .....

Do you already own a computer  
If so, which one do you own? .....

DTP



# ACE GALLERY

ACE READERS PROVE THEIR PIXEL PROWESS...

**H**ere at ACE we're well aware that our readers are a talented bunch and on these pages we're going to prove it. The stunning pieces of artwork that follow have all been produced by ACE readers on their own micros. Impressed? So were we. If you think you can do as well or better, then send your masterpieces to ACE READERS ART, Priory Court, 30-32 Farringdon Lane, London. EC1R 3AU. Your artwork should be supplied on a disk or cassette with a slideshow program that can be paused and loading instructions. Ensure that all disks and tapes are clearly labelled with your name and address. Please enclose a stamped addressed envelope if you require the disk/cassette to be returned.



**SEAN RYAN, Waterford, Ireland  
COMMODORE 64**

These two Batman pics are superb examples of the sort of thing you can do even on a machine with low resolution and a limited colour palette. Sean has not been afraid to put shadow to good effect. This is always a good idea because it gives the picture a more dynamic three-dimensional quality than it would otherwise have. Sean has combined this with the use of lighter colours to produce effective highlights.

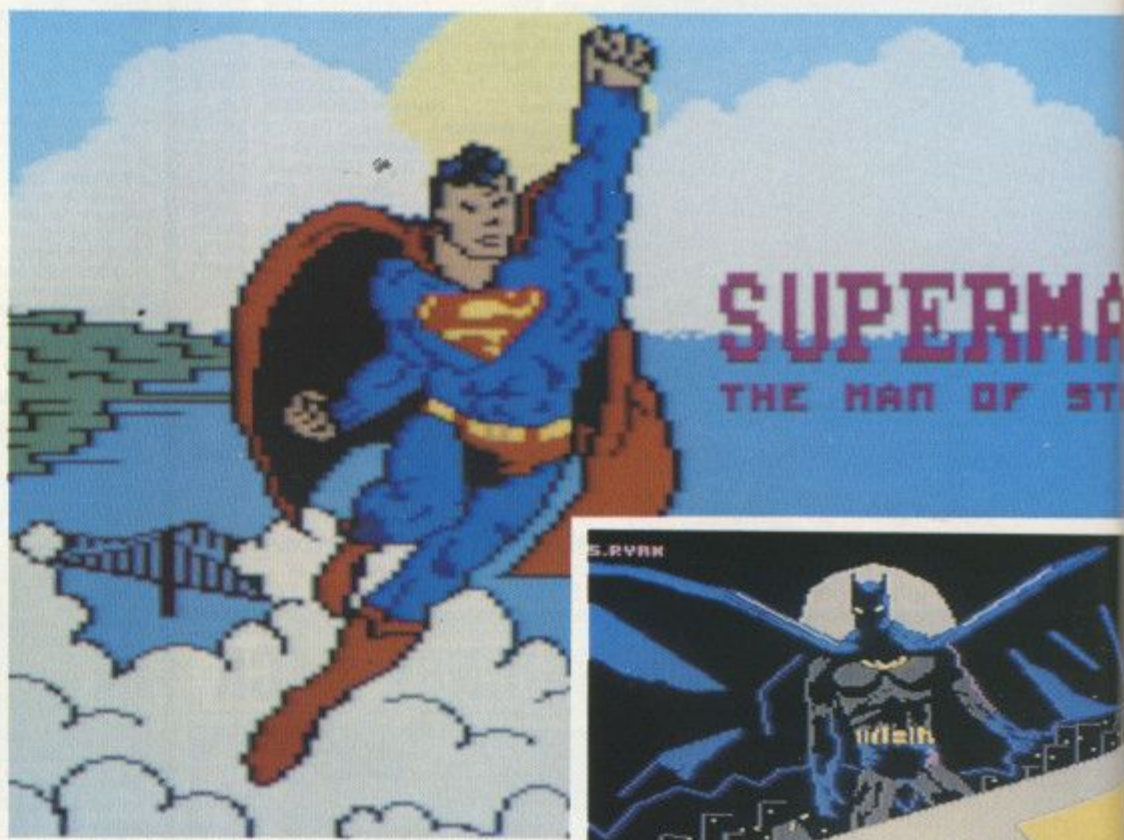

**CHRISTIAN CAPSTAFF, Great Yarmouth  
AMSTRAD CPC 464**

These two pictures just go to show that you don't have to own expensive 16-bit hardware to produce good artwork. Christian drew these pictures of Superman and Roadrunner using OCP's Advanced Art Studio, one of the best art programs available for 8-bit machines.

Both pictures make good use of strong colour and well defined lines to achieve the necessary cartoon-like quality. Notice the good use of shading in the Roadrunner picture to make up for the limited colours available on the CPC.

**ANDREW WALLIS, Brough, North  
Humberside  
ATARI ST**

The Flintstones and Donkey Kong were both initially drawn using Advanced Art Studio, and then finished off with Degas Elite (an excellent ST art package characterised by its ability to run with GDOS and to work in all three screen resolutions).

Andrew has clearly stuck to the principles of cartoon art to produce these pieces. Keep all your lines strong and simple and go for bold, distinctive colours. You will be surprised at the degree of expression, personality and action you can incorporate into a good cartoon without resorting to complex, detailed drawings.

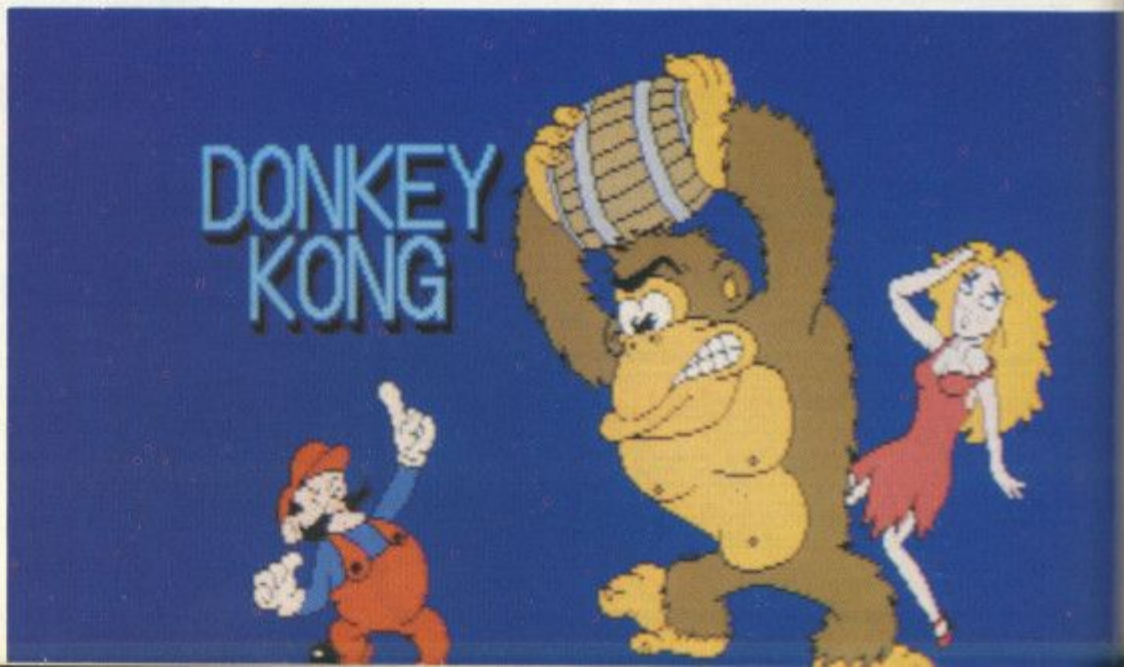





**ANDREW WALLIS, Brough, North Humberside**  
**ATARI ST**

The Flintstones and Donkey Kong were both initially drawn using Advanced Art Studio, and then finished off with Degas Elite (an excellent ST art package characterised by its ability to run with GDOS and to work in all three screen resolutions).

Andrew has clearly stuck to the principles of cartoon art to produce these pieces. Keep all your lines strong and simple and go for bold, distinctive colours. You will be surprised at the degree of expression, personality and action you can incorporate into a good cartoon without resorting to complex, detailed drawings.

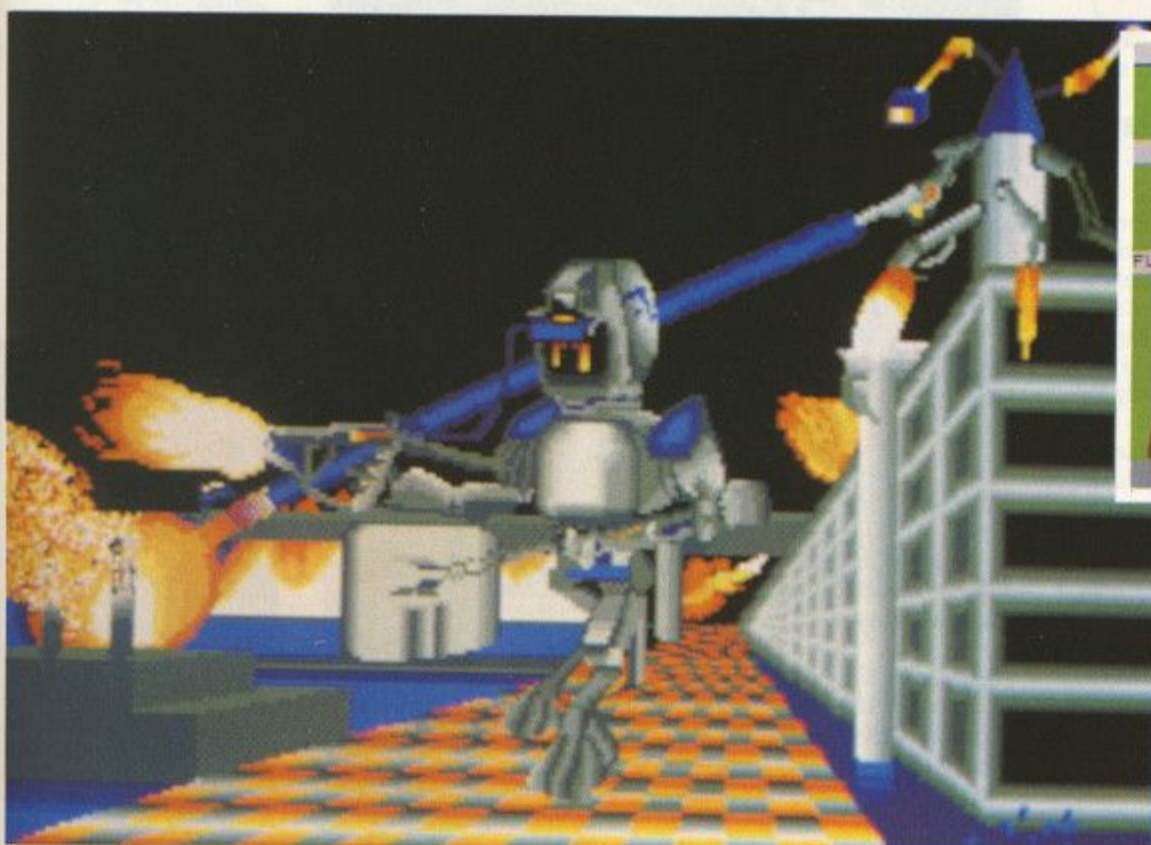

**PoB, London**  
**ATARI ST**

PoB used Degas Elite to produce the colourful robot picture, and an interesting distortion of the standard ST desktop. He tells us that 'because all of the pictures have light shading in them, I had to use the Degas zoom mode to make sure they were accurate enough and had few or no rough edges. I hope these pictures show that almost anything can be achieved with a palette of only 16 colours.'



# 1 BATMAN

## Batman - The Movie from Ocean

Taken from the brilliant blockbuster movie. Prowl the streets of Gotham City in your Batmobile. Come face to face with the dreaded Joker at the Axis Chemical Factory. Analyse the Joker's Nerve Gas in the Batcave and then prepare yourself for the final fight to the death in the cathedral.

- 5 different scenarios
- Superb graphics and sound
- Captures the atmosphere and excitement of the movie perfectly

"It's edge of seat excitement that grips you solidly."

### Amiga Format

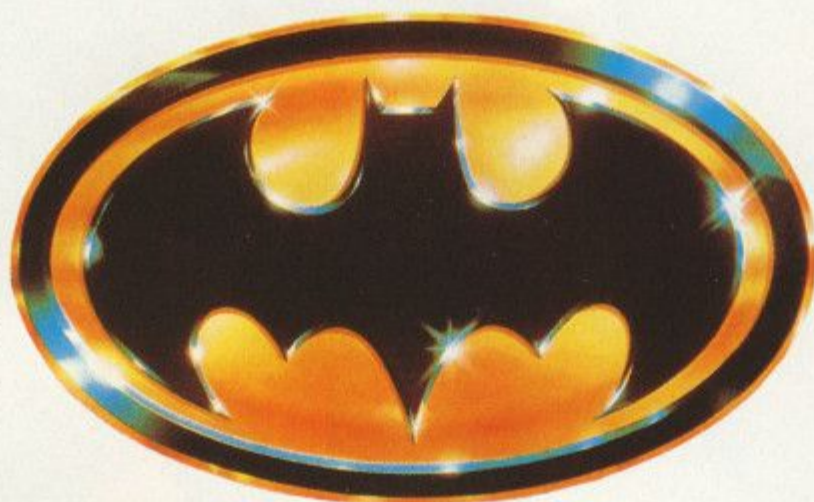

### Batman - The Movie

		PRICE	CODE
Commodore 64	Cass	£ 9.99	BF901CC
Commodore 128	Disk	£14.99	BF902CD
Spectrum 48K	Cass	£ 9.99	BF903SC
Spectrum +3	Disk	£12.99	BF904SD
Amstrad 464	Cass	£ 9.99	BF905AC
Amstrad 6128	Disk	£14.99	BF906AD
Atari ST	Disk	£19.99	BF907ST
Amiga	Disk	£24.99	BF908AM

# THE BIG

An INCREDIBLE way to buy the month's top titles!

## CHOOSE ANY ONE

### BIG FOUR MAIL ORDER

- Fast delivery
- Friendly service
- Fabulous savings

We're backed by the resources of one of Britain's most successful publishers so you can order with confidence.

### It's so simple!

You may find it hard to believe that we're GIVING away software but it's true. You simply buy any of the titles on this page at the normal retail price listed and then you can pick any other title (or the same title on a different format) absolutely free of charge!

The only condition is that the value of the free game must not be greater than that of the game you're paying for.

Apart from that there are no strings attached. It's literally TWO for the price of one! Or FOUR for the price of two...the sky's the limit! Have you ever seen a better offer...?

**FIRST CLASS POST, PACKING & VAT, INCLUDED**

# 3

## Beach Volley from Ocean

Your team travels the globe from London to Sydney challenging all comers in the latest craze that's sweeping the beaches. Fantastic action with variable service and play controls as you lob the defences, try a lightning reflex short smash to win back your service, jump block or defend your match winner.

This is Beach Volley... you may even catch a tan!

THE SUN'S BEATING DOWN,  
ROCK 'N' ROLL MUSIC'S PLAYING...

# Beach Volley

		PRICE	CODE
Commodore 64	Cass	£ 9.99	BF918C2
Commodore 128	Disk	£14.99	BF919CD
Spectrum 48K	Cass	£ 8.99	BF920SC
Spectrum +3	Disk	£14.99	BF921SD
Amstrad 464	Cass	£ 9.99	BF922AC
Amstrad 6128	Disk	£14.99	BF923AD
Atari ST	Disk	£19.99	BF924ST
Amiga	Disk	£24.99	BF925AM

DRIVING'S BEST C...  
JUST BIG

# TURBO

MORE CAR,  
MORE ROAD,  
MORE ACTION



# 4

# 2

## Strider from US Gold

In the eternal struggle between good and evil, both Russians and Russia look very different. You take on the role of Strider Hiryu and need to do battle with The Lord and his wicked minions. You're dropped into Red Square and must guide Strider across platforms destroying KGB agents with your trusty sword.

Get through all this and return to Moscow to face the Grand Master of the Red Army.

*"Arcade fans who like their games spiced with plenty of action and rushing around are certainly going to enjoy this."*

**Amiga Format**

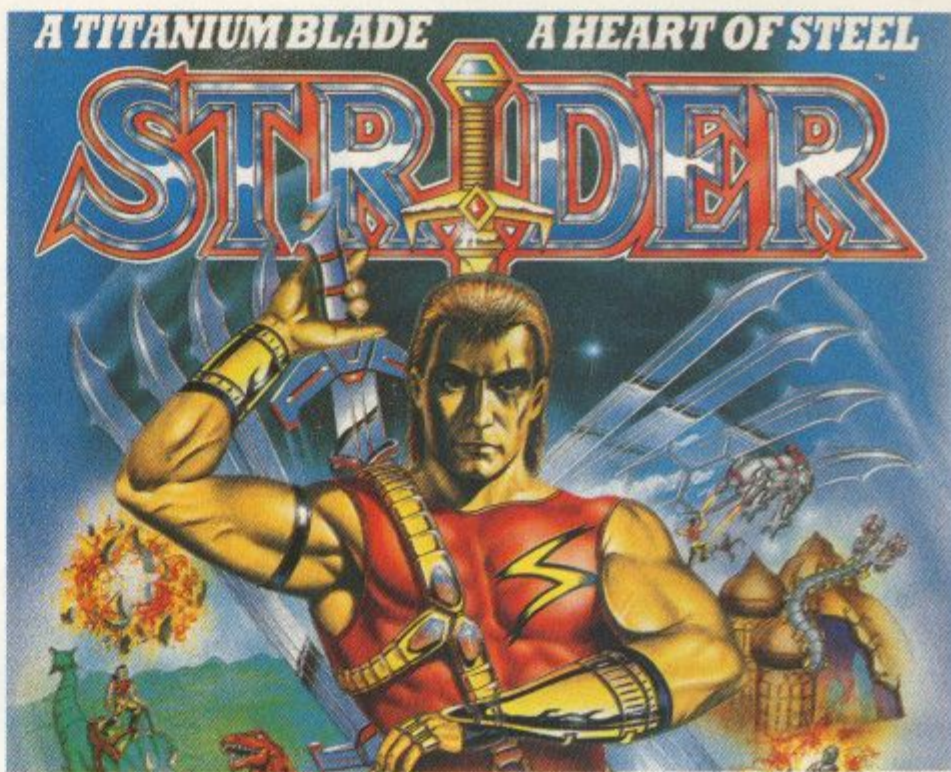

### Strider

		PRICE	CODE
Commodore 64	Cass	£ 9.99	BF909CC
Commodore 128	Disk	£14.99	BF910CD
Spectrum 48	Cass	£ 9.99	BF911SC
Spectrum +3	Disk	£14.99	BF912SD
Amstrad 464	Cass	£ 9.99	BF913AC
Amstrad 6128	Disk	£14.99	BF914AD
Atari ST	Disk	£19.99	BF915ST
Amiga	Disk	£24.99	BF916AM



# GET ONE FREE!

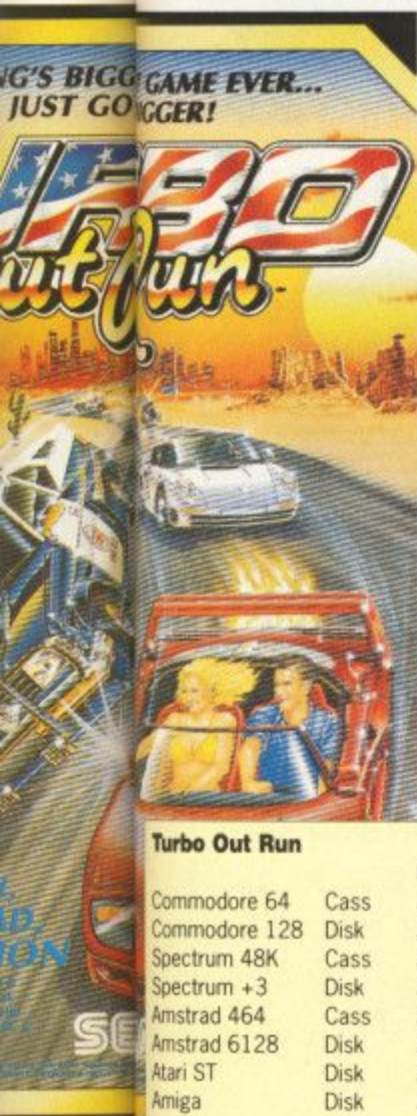

# 4

## Turbo Out Run from U S Gold

Get ready to put your foot to the metal, pedal to the floor, because Out Run is back!

The game takes you on a 4 stage race across America. Driving a Ferrari F40 you'll battle bumper to bumper with good guys and bad guys, police cars, Porsches, blown engines and fickle girlfriends. Sixteen different scenes will take you through congested city streets, over snow and icy mountain passes and across sun-baked deserts.

Drive day-time and night-time and go for manual or auto gear-box selection.

### Turbo Out Run

		PRICE	CODE
Commodore 64	Cass	£ 9.99	BF926CC
Commodore 128	Disk	£14.99	BF927CD
Spectrum 48K	Cass	£9.99	BF928SC
Spectrum +3	Disk	£14.99	BF929SD
Amstrad 464	Cass	£9.99	BF930AC
Amstrad 6128	Disk	£14.99	BF931AD
Atari ST	Disk	£19.99	BF932ST
Amiga	Disk	£24.99	BF934AM

## ORDER HOTLINE 0458 74011

Post to: Big Four Mail Order, The Old Barn, Somerton, Somerset TA11 7PY

**YES**, I want to take advantage of this remarkable way of buying software.

The game(s) I would like to BUY are:

Title	Machine	Order Code	Price

The game(s) I would like FREE are: (You may claim one free title for each game bought. The total price of the free game(s) must not be greater than the total price of the paid-for game(s).)

Title	Machine	Order Code	Price
			<b>FREE!</b>
			<b>FREE!</b>

NAME \_\_\_\_\_

ADDRESS \_\_\_\_\_

POST CODE \_\_\_\_\_

PAYMENT BY:  Cheque  Access  Visa

CREDIT CARD NUMBER \_\_\_\_\_

EXPIRY DATE \_\_\_\_\_

Please make cheques payable to "Big Four Mail Order".



# QuickShot®

by Bondwell

## THE NEXT GENERATION



QS-123  
PC ANALOG

QuickShot offers the most complete selection of video game controllers in the market. Models are available to suit all the most popular video game machines and just about any playing style. And no matter which model you choose, you can be sure you're getting the kind of performance and value for the money that have made QuickShot the biggest name in the business.

Contact us today!

**QuickShot®**  
**20,000,000**  
JOYSTICKS SOLD WORLDWIDE



QS-129N/F\*  
SPACEAGE CONTROL



QS-127  
UNIVERSAL INFRARED



QS-130N/F\*  
DELUXE DIGITAL



QS-128  
UNIVERSAL  
ARCADE-STYLE

**1**  
YEAR GLOBAL  
**WARRANTY**



QS-131  
NEW BASIC

**QuickShot®**  
by Bondwell

BONDWELL UNITED KINGDOM LTD

Vigilant House, 120 Wilton Road, London SW1V 1JZ. Tel: 01-931-8044 Fax.: 01-873-8598

\* N for Nintendo Entertainment System and F for Sega, Atari, Amstrad and Commodore game systems.

© 1989 Spectravideo International Ltd. QuickShot is a registered trademark and QS-123, QS-127, QS-128, QS-129N/F, QS-130N/F and QS-131 are tradenames of Spectravideo International Ltd. Nintendo and Nintendo Entertainment System are trademarks of Nintendo of America Inc. All other product names are registered trademarks or trademarks of their respective companies.



# IN THE PINK

## **NINTENDO COMPO .....145**

Now's your chance to get going with portable games playing. Nintendo are offering you the chance of getting your mitts on the stunning Game Boy pocketable console. Plus – those lovely people are putting up the Nintendo Deluxe NES home system.

## **GAMES YOU'VE GOT TO HAVE .....132**

The ACE updated guide to the games you just have to buy. Check them out, and then look at your collection. Remember – it's coming up to Christmas and time to give yourself a treat

## **BRUCE LEE VIDS! .....160**

Crash! Pow! Mindscape are giving you the chance to add the COMPLETE set of Bruce Lee videos to your collection. And they're offering 10 readers copies of the great Bruce Lee game.! ...

## **ACE READERS PAGES .....158**

Stacks of ads that might just contain the very second hand thing you've been looking for – or the help you need to crack that game that's been bugging you for months.

## **COMPO RESULTS .....154**

Are you in for a big prize? Or even a little one? Find out on our results page.

## **THE ACE PRIZE PUZZLE .....155**

Have you got a brain the size of a planet? Of course you have, and of course this month you really are going to win that exclusive prize for eggheads.

## **CRAZY CAPTION COMPO! .....162**

Richard Branson's in a pickle 'cos he can't get his balloon breath. Now in a competition that's Virgin on the ridiculous we're giving you the chance to win the latest Virgin Mastertronic game – but only if you come up with a brill caption.

## **DIARIES AND DATES .....142**

All the events you need to know about in the coming month...



# Top Quality 2nd Drives for the Amiga and Atari ST at low, low prices

# Evesham MICROS



- ✓ Full compatibility with all Atari ST models, Amiga 500 & Amiga 1000
- ✓ Top quality drive mechanism
- ✓ One megabyte unformatted capacity
- ✓ External plug in PSU (Atari ST)
- ✓ Throughport (Amiga)
- ✓ Very quiet
- ✓ Slimline design
- ✓ Colour matched to computer
- ✓ Long cable for location either side of computer
- ✓ Full 12 months guarantee

**Don't forget - all prices shown include VAT and delivery**

**ATARI ST VERSION ONLY**

**£74.95**

**AMIGA VERSION ONLY**

**£69.95**

including VAT and delivery

## ATARI Hardware Offers

### 520 STFM POWER PACK

Amazing value package from Atari! Includes 520STFM with 1Mb internal drive, games joystick, mouse, user guide, 5 disks of public domain software, plus an incredible selection of chart-topping software (over £500 RRP in total!) Software includes:

R-Type	Pacmania	Out Run	Nebulus
Afterburner	Starglider	Bombuzal	Stargoose
Double Dragon	Super Huey	Xenon	First Music
Super Hangon	Eliminator	Gauntlet II	First Basic
Space Harrier	Predator	Black Lamp	Organiser
Overlander	Bombjack	Starry	

**All for £339.00**  
only inc VAT & delivery

### 520 STFM SUPER PACK

Great value package, comprising of a 520STFM with 1Mb internal drive, games joystick, mouse, user guide, plus 21 extra software titles (£450 total RRP)!

Marble Madness	Test Drive	Chopper X
Beyond Ice Palace	Buggy Boy	Ranarama
Thundercats	Quadrail	Starquake
Summer Olympiad	Xenon	Genesis
Arkanoïd II	Wizball	Black Lamp
Eddie Edwards Ski	Seconds Out	Thrust
Ikar Warriors	Zynaps	Organiser Business S/ware

**only £319.00**  
inc VAT & delivery

**1040 STFM**  
With 1Mb drive,  
1 Mb RAM, plus  
built-in TV modulator  
**£399.00**

**1040 STFM  
HYPER PACK**  
Inc. 'Hyper Paint', 'Hyper Draw',  
'First BASIC' plus 'Organiser' for  
**£429.00**

**1040 STFM  
SUPER PACK**  
Inc. 21 s/ware titles and joystick  
(as with above 520ST package)  
**£429.00**

**520STFM EXPLORER PACK** Package includes 520STFM with 512K RAM, 1Mb Drive and built in TV modulator ..... **£259.00**

520STFM 1MEG internal drive upgrade kit with full instructions .....	£74.95
520 STFM 1MEG memory upgrade kit, requires soldering .....	£79.00
520 STFM 1MEG memory upgrade fitted by us .....	£109.00
1040STFM Hyper-Super Pack: combines extras supplied with 1040STFM Hyper Pack and 1040STFM Super Pack all for only .....	£469.00
Mega ST1 with mono monitor .....	£599.00
Mega ST2 with mono monitor .....	£849.00
Mega ST4 with mono monitor .....	£1099.00
SM124 high resolution monochrome monitor .....	£119.00
SC1224 colour monitor .....	£279.00
Megafile 30Mb hard disk .....	£439.00
Vortex HDplus 40Mb hard disk .....	£499.00
5.25" External 40/80 track drive (360/720K) IBM compatible .....	£99.00
Vidi-ST 16-tone video frame grabber inc. digitising software .....	£95.00
Philips CM8832 colour monitor with ST cable .....	£219.00
Philips CM8833 stereo version of above CM8832, plus A/V inputs .....	£229.00
ITT CP3228 16.5" remote ctrl TV/Monitor, with ST cable .....	£229.00
Pace Linnnet Modem Pack, includes cable and Comms software .....	£179.00
Contriver Hi-Res. Mouse including mouse mat & pocket .....	£22.95
520/1040 STF/STFM Joystick accessibility extension adapter .....	£ 4.95

## AMIGA 500 LOW COST RAM UPGRADE

- ☆ 512K RAM/CLOCK unit : directly replaces A501 expansion
- ☆ Auto-recharging battery backed Real-time Clock
- ☆ Compact unit size ; Ultra-neat design
- ☆ Uses only 4 D-RAM chips for high reliability
- ☆ Low power consumption

**RAM Expansion only £69.00 inc. VAT/delivery**  
Also available without clock for only £59.00

External 5.25" 40/80 track switchable floppy drive for Amiga .....	£114.95
Omega Projects MIDI Interface including 30" serial connection lead ....	£29.95
ITT CP3228 16.5" TV/Monitor with full rem/ctrl & SCART cable .....	£229.00
Philips CM8833 stereo sound colour monitor, c/w Amiga cable .....	£229.00
Pye 2325 15" TV/Monitor with Teletext, rem/ctrl, c/w Amiga cable ....	£269.00
Amiga 500 dust cover .....	£ 4.95

## PRINTERS

All prices include VAT/delivery & cable

LC10



**star**

12 MONTHS ON SITE MAINTENANCE CONTRACTS FOR ANY STAR PRINTER. AVAILABLE AT TIME OF PURCHASE. ONLY £5.75 EXTRA.

Hugely successful 9 pin printer, the Star LC10 provides 4 NLQ fonts (96 print combinations) at 36cps and 144cps draft. Includes 4K buffer and IBM/parallel interface, front panel operation, plus paper parking, allowing single sheets to be used without removing tractor paper.

**Only £169.00**  
Colour version also available,  
**Only £215.00**  
Prices include 2 extra black ribbons free of charge.

Star LC24-10 multifont 24pin printer, amazing new low price .....	£239.00
Star FR-10 9pin 300/76cps with 31K buffer, 16 NLQ fonts, EE-PROM memory & 12 months on-site maintenance .....	£399.00
Star FR-15 wide carriage version of above FR-10 .....	£499.00
Star LC-15 wide carriage version of above LC10 .....	£329.00
Olivetti DM100S super 9pin 200/30 cps, 1 year on-site warranty .....	£129.95
Panasonic KXP1081 reliable + sturdy 9pin 10" printer 120/24 cps .....	£159.00
Panasonic KXP1180 feature-packed multifont 9pin 11" .....	£179.00
Panasonic KXP1124 good specification multifont 24 pin 11" .....	£269.00
NEC P2200 budget 24 pin 168/56cps .....	£279.00
Epson LX400 (was LX800) budget 10" 180/25 cps .....	£179.00
Citizen 120D budget 9 pin printer 120 cps .....	£139.00
Mannesmann Tally MT-81 130/24 cps .....	£149.00

## 3.5" Disks

10 Bulk packed DS/DD 3.5" disks with labels, fully guaranteed .....	£ 9.95
25 bulk disks as above .....	£22.95
10 disks as above with plastic case .....	£11.95
25 disks as above, with 40 capacity lockable storage unit .....	£29.95
Kodak DS/DD 3.5" disks, top quality storage media fully guaranteed. Box of 10 ...	£17.95

## How to order from Evesham Micros



Phone us with your ACCESS or VISA card details on :  
**0386-765500**

All prices include VAT and delivery. Express Courier delivery £5.00 extra.

Send cheque, Postal Order or ACCESS/VISA card details

Govt., educ. & PLC orders welcome  
Same day despatch whenever possible  
All goods subject to availability, E.&O.E.  
Open to callers 6 days, 9.30-5.30

Retail outlets also at : 1762 Pershore Road, Cotteridge, Birmingham B30 3BH Tel: 021 458 4564  
5 Glisson Road, Cambridge CB1 2HA Tel: 0223 323898

**Evesham Micros Ltd**  
63 BRIDGE STREET  
EVESHAM  
WORCS WR11 4SF  
0386-765500  
fax 0386-765354



conversions of the year that should not be missed.

★ ACE RATED 934

### RVF

Microstyle, ST £24.99, Amiga £29.99

RVF offers a near endless supply of fast paced bike action as you race your Honda RVF. Attention to detail is paid out all along the route with your rider giving the bike a push start after a crash.

An excellent mix of arcade and simulation.

★ ACE RATED 915

### SPIDERTRON-IC

Ere International ● Atari ST £19.95dk

Guide your spider-like character around the game area, collecting coloured panels in the correct order. The built-in construction set means you'll be knocking out your own levels till the cows come home.

★ ACE RATED 903

### SUMMER GAMES

Epyx/US Gold ● C64 £9.95 cs £14.95dk ● IBM PC £29.95dk

Epyx sporting simulations are of high quality but none have quite captured the playability and style of the original *Summer Games* and its immediate successor, *Summer Games 2*. One to six players can take part in high jump, gymnastics, springboard diving, clay pigeon shooting, swimming, pole vault – and others – with lovely large graphics and smooth animation throughout. Control of your athlete can be complex so practice is recommended.

★ ACE CLASSIC

### SUPER SPRINT

Electric Dreams ● C64 £9.99cs £14.99dk Amstrad £9.99cs Spectrum £9.99cs ● Atari ST £19.99dk

One of the better coin-op conversions currently available. With up to three

players all competing at once, the action is fast and furious and it will take a finely-tuned car to complete some of the more tortuous circuits that appear later in the game.

★ ACE RATED 907

### THRUST

Firebird ● Spectrum £1.99cs ● C64 £1.99cs ● Amstrad £1.99cs

Terrifyingly sensitive controls and a large helping of real-life physics make this budget title an absolute must. Flying down through the caverns of an enemy-held planet, you have to pick up fuel and destroy hostile gun turrets without crashing into the tunnel walls.

Tough enough as it is, but then you've got to make the return journey with a heavy load slung under your craft. Very mean, very addictive.

★ ACE CLASSIC

### URIDIUM

Hewson ● Spectrum £8.95cs ● C64 £9.95cs £12.95dk ● BBC £9.95cs £14.95dk

The piece de resistance of scrolling shoot-em-ups: blast the dreadnought and attacking ships while dodging around any large structures. Great metallic-looking dreadnoughts and the smoothest scrolling you'll ever see put this head and shoulders above the opposition. A game not to be missed, especially now that C64 versions come packaged with the excellent *Paradroid*.

★ ACE CLASSIC

### ZARCH / VIRUS

Superior Software ● Archimedes £19.95dk ● Firebird (16 and 8-bit versions) Amiga £19.95dk ● Atari ST £19.95dk ● Some 8-bit versions under development

A solid three dimensional shoot-em-up with such graphic perfection and timelessly addictive gameplay that it became an instant classic. Now the 16-bit versions have arrived and they're just as

## ADVENTURES

After a brief surge of RPG-related popularity, the traditional text-entry adventure is rapidly disappearing. But for those of you who savour the powers of the imagination, the verbal twist, and the thrill of encountering other characters, this game genre still has much to recommend it. Here are some of the all-time great computer fantasies...

good as the 32-bit versions.

★ ACE RATED 981

### BEYOND ZORK

Infocom/Activision ● C64 £19.99dk ● PC £24.99dk ● Amiga £24.99dk ● Atari ST £24.99dk

Infocom's attempt to muscle in on the role-playing market is a great success. Locate the fabulous Coconut of Quendor in a game that combines the wit and ingenuity of one of the world's most original software companies with state-of-the-art parsing and gameplay. Text-only, but with an on-screen mapping facility.

★ ACE RATED 902

### CORRUPTION

Rainbird ● Atari ST £24.95dk ● Amiga £24.95dk ● PC £24.95dk ● Spectrum £15.95dk ● C64 £17.95dk ● Amstrad 6128 £19.95dk

This tale of insider dealings, infidelity and crooked business deals is unlikely to appeal to adventurers who prefer to wander through vast dungeon networks seeking treasure. But for those who are fed up with traditional adventuring, it's like a breath of fresh air. Superb graphics, great atmosphere and a nail-biting plot makes this a terrific game that grips from the start.

★ ACE RATED 920

### FISH

Magnetic Scrolls ● PC £24.99dk Amiga £24.99dk

More gameplay than *Corruption*, better game design than *Jinxter*, and not as quirky as *The Pawn*. This is definitely MS's best release since *Guild Of Thieves*. Good stuff indeed.

★ ACE RATED

### GUILD OF THIEVES

Rainbird ● C64 £19.95dk ● Spectrum £15.95dk ● Amstrad 6128 £19.95dk ● Amiga £24.95dk ● Atari ST £24.95dk ● PC £24.95dk

One of Britain's newer adventure software houses – Magnetic Scrolls – managed to produce a traditional treasure hunt with superb graphics and some very tricky puzzles. Powerful parser helps to create a convincing game world with humour and imagination.

★ ACE CLASSIC

### INGRID'S BACK

Level 9 ● Atari ST £19.95dk

A great follow-up to *Gnome Ranger*. Level 9 have really got to grips with the use of characters in their games and how to program them very effectively.

★ ACE RATED 920

### JEWELS OF DARKNESS

Rainbird ● C64 £14.95cs ● Spectrum 128 £14.95cs ● Amstrad £14.95cs £19.95dk ● PC £19.95dk ● Amiga £19.95dk ● Atari ST £19.95dk

Level 9 have put together three of their classic releases, *Colossal Adventure*, *Dungeon Adventure* and *Adventure Quest* in one bundle. The games have been updated with graphics and larger vocabularies and are as close to the original spirit of adventuring as you're likely to find.

★ ACE CLASSIC

### LURKING HORROR

Infocom/Mediagenic ● C64 £19.99dk ● ST £24.99 I Amiga £24.99 ● PC £24.99

Infocom's tribute to H.P. Lovecraft and the horror-fantasy genre sends you into a cold sweat as you discover something very nasty lurking beneath your college laboratory. Superb text-only game that defies you to play it after dark...

★ ACE CLASSIC

### TIME AND MAGIK

Mandarin ● Spectrum £14.95cs £14.95dk ● C64 £14.95cs £14.95dk ● Amstrad £14.95cs £14.95dk ● Atari ST £19.99dk ● Amiga £19.99dk ● PC £19.99dk

This compilation of the Level 9 games, *Lords Of Time*, *Red Moon* and *The Price Of Magik* have been re-vamped with better parsing, bigger vocabularies and pictures added. Superb value if you don't already own them.

★ ACE RATED 919

### ZORK ZERO

Infocom Versions due out about now. Watch this space for price info. Highly enjoyable with a variety of challenges that make for instant addiction. A bit more character interaction would have made this a real humdinger, but even so it remains one of the

## PUZZLES

If you're after a game that will provide you with a real challenge, without necessarily requiring large doses of strategic thinking, then it's a puzzle game you want.

### BONE-CRUNCHER

Superior Software ● C64 £9.95cs £11.95dk ● Amiga £14.95

At first sight this recent release may appear to be nothing more than a boulderdash rip-off. However there are a number of innovative gameplay features which give *Bonecruncher* a feel all of its own. Highly recommended for those who prefer to solve problems rather than shoot them.

★ ACE RATED 948 – AMIGA

### BOULDERDASH

Prism Leisure Corporation ● Spectrum £2.99cs ● C64 £2.99cs ● Amstrad £2.99cs

A game that has everything – instant addiction, long-term challenge, fre-

netic excitement as the clock ticks down and extremely tricky puzzles. You must collect jewels hidden in caverns, digging away earth and boulders to get at them. Boulders can drop and cause you serious damage, while the jewels are often hidden by seemingly impenetrable walls. Complex but great fun. Boulderdash is a classic you can't afford to miss in its budget incarnation.

★ ACE CLASSIC

### DEFLEKTOR

Gremlin/Vortex ● C64 £9.99cs ● Spectrum £7.99cs ● ST £19.95dk

Optics are the order of the day here (not the spirit dispensers) as the player tries to connect a laser beam to a receiver and at the same time destroy a



**Authorised  
AMIGA  
B2000  
CENTRE**

**WE DON'T  
HIDE OUR  
PRICES  
EXCLUDING  
VAT**

**SPECIALISTS IN MAIL ORDER**  
**WHY MEGALAND**

24 HOUR DELIVERY • 12 MONTHS WARRANTY ON ALL HARDWARE  
ON SITE MAINTENANCE OPTIONAL • TECHNICAL SUPPORT  
HELPFUL FRIENDLY SERVICE • SPECIAL PRICE OFFERS  
MEGASOFT CLUB MEMBERSHIP FOR EXTRA SPECIAL OFFERS  
EXPORT SPECIALISTS (ASK FOR DETAILS 0703 332225)

**AMSTRAD  
ADVANCED  
SYSTEMS  
CENTRE**

**YOU  
LUCKY  
PEOPLE**

**MEGALAND BRANCHES AT SOUTHAMPTON AND OXFORD**

AMIGA B2000  
8833 OR 1084D COLOUR  
MONITOR, 20MB HARD DISK  
XT BRIDGEBOARD  
SUPER PRICE  
**£1329**  
INC. VAT

PHILIPS 8833  
COLOUR STEREO MONITOR  
PLUS CABLES  
PRICE  
**£235**  
INC. VAT

C64 128 EXTERNAL DRIVE  
1541 ONLY  
PRICE  
**£130**  
INC. VAT

STAR LC24-10 PRINTER  
NLQ 24 PIN  
PLUS FREE CABLE  
PRICE  
**£235**  
INC. VAT



MEGALAND SUPER PACK ONE PLUS  
AMIGA A500  
(SEE STANDARD FEATURES)  
BATMAN THE MOVIE (GAME),  
F18 INTERCEPTOR, NEW ZEALAND  
STORY, DELUXE PAINT II, EXOLON,  
BATTLE VALLEY, CYBERNOID II,  
SLAYER, ZYNAPS, KARTING GRAND  
PRIX, ROCKY, PLATOON, FLIGHTPATH  
737, QUAIMODO, SPACE STATION,  
MEGA BLASTER JOYSTICK, MOUSE PAD,  
DUST COVER, 10 BLANK DISKS.  
PRICE **£399** INC. VAT

AMIGA A1010 3.5 DRIVE  
PRICE  
**£85**  
INC. VAT

**CHRISTMAS  
CRACKERS  
FROM TOYLAND  
MEGALAND**

MEGALAND SUPER PACK TWO PLUS  
AMIGA A500  
(SEE STANDARD FEATURES)  
BATMAN THE MOVIE GAME,  
F18 INTERCEPTOR, NEW ZEALAND  
STORY, DELUXE PAINT II, ROGER  
RABBIT, STARRAY, NEBULUS,  
PLATOON, HYPERDOME, MOUSE PAD,  
10 BLANK DISKS, QUICKSHOT II  
JOYSTICK, TAILORED AMIGA  
DUST COVER.  
PRICE **£399** INC. VAT  
ONLY WHILE  
STOCKS LAST

MEGALAND SUPERPACK THREE PLUS  
AMIGA A500  
(SEE STANDARD FEATURES)  
BATMAN THE MOVIE (GAME),  
F18 INTERCEPTOR, NEW ZEALAND  
STORY, DELUXE PAINT II, EXOLON,  
BATTLE VALLEY, CYBERNOID II,  
SLAYER, ZYNAPS, PHANTASM, CHAMP  
FOOTBALL, GALACTIC INVASION,  
WIZBALL, ICE HOCKEY, MOUSE PAD,  
DUST COVER, 10 BLANK DISKS, AND  
MEGA BLASTER JOYSTICK.  
PRICE **£399** INC. VAT

AF880 3.5 EXTERNAL DRIVE  
ON/OFF SWITCH  
PRICE  
**£75**  
INC. VAT

AMIGA 3.5 EXTERNAL DRIVE  
WITH ON/OFF SWITCH AND  
STEEL SLIM CASE  
PRICE  
**£75**  
INC. VAT

ATARI 520  
EXPLORER PACKS  
PRICE  
**£265**  
INC. VAT

PHILIPS  
PC COMPUTER  
DUAL DRIVE  
MONO MONITOR  
PRICE  
**£525**  
INC. VAT

PSION ORGANISER  
WE STOCK THE  
PRICES  
**£795**  
INC. VAT  
AN IDEAL CHRISTMAS PRESENT

**MEGALAND SOUTHAMPTON**  
42 - 44 Millbrook Road East  
Southampton, Hants., SO1 0HY  
TELEPHONE 0703 332225

**MEGALAND OXFORD**  
Islip Road, Off Hernes Road  
Oxford. TEL 0865 512599  
OR 0865 512633

**OFFICIAL ORDERS**  
Welcomed from Corporates,  
Government, Educational,  
Health, & M.o.D. Establishments

**ACCOUNTS TERMS**  
30 Days from date of invoice.  
Phone for further information.

**OPEN MONDAY TO SATURDAY 9.00am to 5.30pm**





## CREDIT CARD MAIL ORDER - PHONE NOW

MEGALAND NOW OFFER THE BEST GAMES PACKS THIS SIDE OF THE PLANET. ALSO ALL OUR PACKS CONTAIN AMIGAS WITH THE FOLLOWING STANDARD FEATURES.

★ ALL UK SPECIFICATION ★

AMIGA A500, 512K RAM, 1 MB 3.5 DRIVE, MOUSE, THREE OPERATING MANUALS, 4096 COLOURS, KICKSTART 1.3, TUTORIAL DISK, UTILITIES DISK, WORKBENCH 1.3 DISK, POWER SUPPLY, TV MODULAR, MULTI TASKING SCREENS, BUILT IN VARIABLE SPEECH SYNTHESIZER, PLUS ALL CONNECTING CABLES.

All prices and manufacturers specifications subject to change without notice. All offers subject to availability. Offers subject to change in price without notice.

**Delivery Charges**

24 hour Courier Service £10.00  
4 Day Courier Service £5.00  
Consumables Free Post  
Overseas Orders Phone

**HOTLINE RETURNS SERVICE AND TECHNICAL SUPPORT TELEPHONE**  
**0703 330544**

STANDARD COLOUR PRINTER  
NLQ 9 PIN  
PLUS FREE CABLE

PRICE  
**£195**  
INC. VAT

STAR LC10 MONO PRINTER  
9 PIN DOT MATRIX  
NLQ STILL A VERY POPULAR  
PRINTER PLUS FREE CABLE

PRICE  
**£149.95**  
INC. VAT

AMIGA A501 RAM EXPANSION  
WITH CLOCK & CALENDAR

PRICE  
**£115**  
INC. VAT

THE NEW LIGHT FANTASTIC  
PACK COMMODORE 64

The pack includes C64 computer, power supply, cassette unit, light gun, 3D glasses, Robocop, Rambo III, Platoon, Hypersports, Combat School, Batman the caped crusader, Mike Reids pop quiz, 3D action pack Army Days, Gangster and Time Traveller. Plus arts package, music creator, typing tutor and Shootem Up construction kit.

PRICE  
**£149.99**  
INC. VAT

A500 AMIGA  
A590 20MB HARD DISK  
AUTO BOOT (1.3 KS ONLY)

PRICE  
**£375**  
INC. VAT

PANASONIC KXP 1081  
9 PIN PRINTER  
PLUS FREE CABLE

PRICE  
**£149**  
INC. VAT

Megaland thank all their customers for their support and would like to wish them a Happy Christmas and New Year.

PANASONIC KXP 1124  
24 PIN PRINTER  
VERY POPULAR  
PLUS CABLE

PRICE  
**£285**  
INC. VAT

MEGALAND SUPER PACK FOUR PLUS  
AMIGA A500  
(SEE STANDARD FEATURES)  
BATMAN THE MOVIE (GAME),  
F18 INTERCEPTOR, NEW ZEALAND  
STORY, DELUXE PAINT II,  
QUICK SHOT II JOYSTICK,  
A501 RAM EXPANSION

PRICE **£485** INC. VAT



ALL PRICES INCLUDE VAT UNLESS STATED

To: 42-44 Millbrook Road East, Southampton

I wish to order \_\_\_\_\_

I enclose cheque/PO for £ \_\_\_\_\_ inc VAT.

Or charge my Access/Visa No. \_\_\_\_\_

Exp. date \_\_\_\_\_

\_\_\_\_\_

Name \_\_\_\_\_ Signature \_\_\_\_\_

Address \_\_\_\_\_

Postcode \_\_\_\_\_

Tel No: \_\_\_\_\_

PRICES CORRECT ON DATE GOING TO PRESS

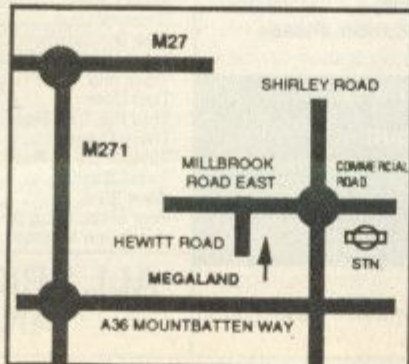
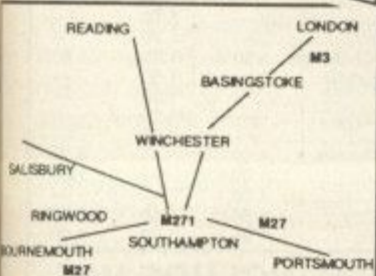

APPROACH VIA MILBROOK ROAD M271 TOWARDS TOWN TURN LEFT ONTO MOUNTBATTEN WAY BEFORE STATION TURN LEFT TOWARDS SHIRLEY AFTER 50 YARDS LEFT BY MILLBROOK ROAD EAST. MEGALAND IS 30 YARDS ON THE LEFT. 3 MIN WALK FROM STATION





# RAPID SERVICE SOFTWARE

SUPPLIERS OF QUALITY SOFTWARE



TITLE	AMIGA	IBM/PC	ST
Airbourne Ranger	17.50	17.50	17.50
Altered Beast	18.99	—	14.99
APB	14.99	18.99	14.99
Arkanoid	9.99	—	—
Arkanoid 2	9.99	—	14.99
Army Moves	7.99	—	—
Backlash	—	—	7.99
Bad Company	18.99*	—	18.99*
Barbarian (Palace)	7.50	—	7.50
Barbarian II (Palace)	17.50	17.50	17.50
Bards Tale	7.50	—	7.50
Batman the Movie	18.99	—	14.99
Battlechess	18.99	18.99	18.99
Beach Volley	18.99	—	14.99
Blade Warrior	18.99	18.99	18.99
Blood Money	17.50	—	17.50
Bloodwych	18.99	18.99	18.99
Bloodwych	—	—	—
Data Disc	10.99	—	10.99
Bomber	22.99*	—	22.99*
Bridge Player 2150	—	—	—
Galactica	20.99	20.99	20.99
Budokan	18.99*	—	—
Cabal	18.99	—	18.99
Captain Blood	7.50	—	7.50
Carrier Command	17.50	24.50	17.50
Centrefold	—	—	—
Squares	13.99	13.99	13.99
Chambers of Shaolin	17.50	—	13.99
Chase HQ	18.99	—	14.99
Collosus Chess X	17.50	17.50*	17.50
Conflict Europe	18.99	18.99	18.99
Continental Circus	14.99	—	14.99
Damocles	17.50	—	17.50
Deluxe Strip Poker	13.99	13.99	13.99
Destroyer	7.99	—	—
Double Dragon II	14.99	—	14.99
Drakken	22.99	22.99	22.99
Dungeon Master	18.99	29.99*	18.99
Dynamic Debugger	18.99	—	18.99
Dynamite Dux	18.99	—	14.99
Eye of Horus	18.99	18.99	18.99
F16 Combat Pilot	17.50	17.50	17.50
Falcon	20.99	26.25	18.99
Falcon	—	CGA	—
Falcon	—	EGA	—
Falcon Mission Disc	14.99	—	14.99
Fast Lane	14.99	—	14.99
Federation of Free Traders	22.50	—	22.50
Fiendish Freddy	18.99	—	18.99
Ferrari Formula 1	18.99	18.99	18.99
Firezone	7.99	—	—
Funschool 2	13.99	13.99	13.99
Gazzas Super Soccer	17.50	—	17.50
Ghostbusters II	18.99	22.99	18.99
Ghouls and Ghosts	18.99	—	14.99
Hard Drivin	18.99	18.99	18.99
Infestation	17.50	—	17.50
Indiana Jones Arcade	14.99	18.99	14.99
Indiana Jones Adventure	18.99*	22.50*	18.99
Interphase	18.99	18.99*	18.99
Irontrackers	—	—	13.99
Karate Kid II	7.99	—	—
Kenny Dalglish Soccer Manager	14.99	—	14.99
Kick Off	17.50	—	17.50
King Arthur	—	18.99	—
Knightforce	17.50	17.50	17.50
Laser Squad	13.99	—	13.99
Leaderboard	7.50	—	7.50
Lombard RAC Rally	17.50	17.50	17.50
Mastersound	34.99*	—	34.99
Menace	13.99	17.50	13.99
Micropose Soccer (3.5" only on PC)	17.50	17.50	17.50
Mighty Mail	—	—	7.99
Moonwalker	18.99*	18.99*	18.99*
Mortville Manor	—	—	7.99
Never Mind	13.99	17.50	13.99
New Zealand Story	18.99	—	14.99
North and South	17.50	—	17.50
Omega	18.99	18.99	18.99
Ooze	18.99	18.99	18.99
Outrun	7.50	18.99	7.50

## LOOK! LOOK! LOOK!

FREE PUBLIC DOMAIN OR DEMO DISC ON ALL ST/AMIGA ORDERS OVER £10

ALL ST/ AMIGA SOFTWARE CHECKED FOR LOADING BEFORE DESPATCH

WE ALSO SUPPLY SOFTWARE FOR THE FOLLOWING COMPUTERS:  
ATARI VCS 65XE, BBC/ELECTRON  
COMMODORE 64, 16, VIC 20, SPECTRUM  
AMSTRAD MSX, DRAGON LYNX SORD M5

FOR YOUR FREE CATALOGUE AND £1.00 SOFTWARE VOUCHER-

CALL 0625 615639

TITLE	AMIGA	IBM/PC	ST
Paperboy	13.99	17.50	13.99
Pacland	7.99	—	—
Personal Nightmare	20.99	—	20.99
Personal Money Manager	—	—	7.99
Pirates	—	—	17.50
Pictionary	18.99	18.99	18.99
Pool of Radiance	TBA	22.50	TBA
Populous	18.99	18.99	18.99
Populous	—	—	—
Data Disc	7.50	7.50	7.50
Postman Pat	6.99	—	6.99
Power Drift	18.99	—	14.99
Power Struggle	7.99	—	7.99
Peter Beardley's Soccer	7.99	—	—
P47	17.50	17.50	17.50
Questron II	7.99	—	—
Rainbow Warrior	17.50	—	17.50
Rick Dangerous	17.50	17.50	17.50
Robocop	18.99	—	14.99
Rocket Ranger	22.49	22.49	22.49
Rommel	—	18.99	—
RVF Hona	17.50	17.50	17.50
Shadow of the Beast	26.50	—	TBA
Shinobi	14.99	—	14.99
Shufflepack Cafe	14.99	—	14.99
Skidz	13.99	13.99	13.99
Sleeping Gods Lie	17.50	20.99	17.50
Space Ace	31.49	31.49*	31.49
Sporting Triangles	13.99	—	13.99
Strider	18.99	18.99	18.99
Steve Davies Snooker	13.99	—	13.99
Stos	—	—	22.50
Stos Compiler	—	—	13.99
Stos Sprites	—	—	10.50
Stos Music Maestro	—	—	17.50
Stos Music Maestro + Hardware	—	—	57.50
Targhan	18.99	22.50	18.99
Terrys Big Adventure	10.99	—	10.99
Thunderblade	—	—	7.99
TV Sports Football	22.50	—	18.99
Turbo Outrun	18.99*	—	14.99*
UMS	17.50	17.50	17.50
UMS Mission Disc	10.50	—	10.50
Ultimate Darts	14.99	—	14.99
Ultimate Golf	18.99	18.99	18.99
Utilities	—	—	7.99
Verminator	—	—	17.50
Vette	—	22.50	—
Vegas Gambler	—	—	7.99
War in Middle Earth	14.99	18.99	14.99
Weird Dreams	17.50	17.50	17.50
Xenon II	18.99	18.99	18.99
Xenophobe	17.50	17.50	17.50
Zak McCracken	18.99	18.99	18.99

\* = Not Released At Time Of Publication. Please Phone For Details.

PLEASE MAKE CHEQUES/PO PAYABLE TO:

RAPID SERVICE SOFTWARE  
P.O. BOX 57  
MACCLESFIELD  
CHESHIRE  
SK11 6JE  
TEL 0625 615639

\* Valid against £10 orders and over  
\* Not released at the time of publication. Please Phone for details.

## PERIPHERALS

10 X 3" CF2 Discs	23.99
Quickshot II Joystick	6.99
Cheetah 125+ Joystick (Suitable for Spectrum +2 and +3)	8.99
Cheetah Mach 1 Joystick	9.99
Competition Pro 5000 Joystick	14.99
Zip Stick Super Professional with A/F Joystick	14.99
Zip Stick Super Professional for BBC	16.99
Electron Joystick Interface	14.99
BBC Joystick Interface	9.99
Spectrum Single Port Interface	9.99
Spectrum Twin Port Interface	14.99
Amstrad 464 664 6128 Joystick Converter	3.99
For 2 Joysticks	—
Amstrad Joystick Auto Fire Unit	5.99
IBM PC Joystick	19.99
IBM PC Game Card	19.99
Amiga or ST Player Lead	5.99
Amiga A500 Ram Expansion with our clock	89.99
C64 Power Supply	18.99
48k Spectrum Power Supply	9.99
128k Spectrum Power Supply (not +2a or +3)	13.99
Electron Power Supply	9.99
C16/14/C64/Vic Tape Player	21.50
Load It Tape Player for the above	34.99
SPE/MSX/BBC/ELE Tape Player	15.00
Amstrad 664/6128 Tape Lead	4.99
BBC/Electron Tape Lead	4.99
Spectrum +3 Tape Lead	3.99
Spectrum 48k Tape Lead	1.99
ST to ST AMIGA to AMIGA	—
ST to AMIGA Lead	9.99
Amiga Modulator	24.99
ST/AMIGA/64C/464 Keyboard Dust Cover	4.99
Mouse Mat	3.99
Atari ST Replacement Mouse	24.99

## 3.5" BULK PACKED DISCS

10 - £6.00  
25 - £13.75  
50 - £25.00  
100 - £48.00

While Stocks Last

## SPECIAL OFFERS

TITLE	AMS	C64	SPE
Action Forcer 2	—	—	1.50
Armagecepon Man	2.50	2.50	2.50
Aqunaut	—	1.50	—
Best of Elite Vol 1	2.99	—	—
Best of Elite Vol 2	2.99	—	—
Bulls Eye	—	2.99	—
Catch 23	1.50	—	—
Camelot Warriors	1.50	1.50	1.50
Countdown	2.99	—	2.99
Dan Dare 2	1.50	—	—
Deactivators	1.50	1.50	1.50
Deflektor	—	1.50	1.50
Dogfight 2187	1.99	1.99	1.99
Election	—	1.50	—
Escape from Singes Castle	1.99	1.99	1.99
Falcon the Renegade Lord	—	1.99	—
Firezone	2.50	—	—
Flunky	1.50	1.50	1.50
Gary Linekars Superstar Soccer	—	—	2.99
Greyfall	—	1.50	1.50
Hydrofool	—	—	1.99
Hysteria	—	—	1.99
Laserdisc	4.99	—	4.99
Livingstone	1.50	—	1.50
Nemesis the Warlock	—	1.50	—
Now Games 5	—	—	2.50
Pile Up	—	1.50	—
Popeye	1.50	—	—
Price of Magic	—	1.99	1.99
Pulsator	1.50	3.99	1.50
Mickey Mouse	—	disc	—
Quill/Illustrator	4.99	—	—
Red LRD	—	—	1.50
Slaine	—	—	1.50
Secret Diary of Adrian Mole	—	1.75	—
Snow Queen	—	1.99	1.99
Sorcerer Lord	—	2.50	—
Task 3	—	1.50	—
Transatlantic Balloon Challenge	1.50	1.50	1.50
Track and Field	—	1.50	—
Trap Door	—	1.50	—
Thru the Trap Door	—	1.50	—
Trivial Pursuit	—	4.99	—
Trivial Pursuit Young Players	4.99	—	4.99
Twice Shy	—	1.99	1.99
West Bank	—	1.99	—
Yogi Bear	1.50	1.50	1.50
Yes Prime Minister	1.99	1.99	1.99

ALL PRICES INCLUDE VAT AND DELIVERY



number of cells that are on screen as well. You'll need to make full use of the mirrors, fibre-optic conduits and polarising and refracting blocks if you're to achieve your aim. Clear the first screen and you'll only have 59 more to do. Fascinating stuff that's horribly addictive.

★ ACE RATED 906 - ST

## NEBULUS

Hewson ● C64 £9.99cs  
£14.99 dk ● Atari ST  
£14.99 dk

Guide pogo to the top of eight towers using the spiral of platforms, lifts and ledges that form the route. It's a highly original game that strikes a fine balance between frustration and addiction, added to which is the rotary scroll, thus making it a good-looking, playable winner of a game.

★ ACE RATED 943 - C64

## SENTINEL

Firebird ● Spectrum £9.95cs ● C64 £9.95cs  
£14.95dk ● Amstrad  
£9.95cs £14.95 dk ●  
Atari ST £19.95dk ●  
Amiga £19.99dk

Bizarre and compelling strategy game played over the chequered surface of a planet dominated by the Sentinel. Fundamentally you have to absorb energy while trying to stop the Sentinel from absorbing yours. A clean brain and fast trigger finger are both necessary in this very original and large - 10,000 possible landscapes - game.

★ ACE RATED 963 - AMIGA

## SKULL DIGGERY

Nexus ● Atari ST £19.95

Boulderdash clone that completely outdoes the original on this particular machine. Again (see Boulderdash above) you're digging for diamonds in caverns over a hundred different screens - with a time limit for each screen. Skulldiggery scores on playability (easier screens to begin with and a choice of starting point) and its entertaining two-player

option.

★ ACE RATED 919 - ST  
SPORE

Bulldog ● C64 £1.99cs ●  
Amstrad £1.99cs ● Spec-  
trum £1.99cs

The winning combination of strategy, frenzied blasting and great graphics make Spore a worthy full-priced release - what a bargain then to be able to pick it up for £1.99!

★ ACE RATED 919 - C64

## TETRIS

Mirrorsoft ● Spectrum  
£8.99cs ● C64 £8.99cs  
£12.99dk ● Amstrad  
£8.99cs £12.99 dk ●  
Atari ST £19.95dk ●  
Amiga £19.99dk ● IBM  
PC £19.99dk

A fascinating geometrical oddity, this Russian puzzler turns the obscure mathematical topic of packing into a cult game. One at a time, shapes fall downwards into a rectangular playing area. Left to their own devices they'll pile up until they reach the top of the screen; your task is to guide them down and pack them tightly so that doesn't happen. Different versions have proved to be rather variable in their arcade aspects, but the brilliantly simple idea behind them means they're well worth a look whatever your machine.

★ ACE RATED 959 - C64

## THINK!

Firebird ● C64 £1.99cs ●  
Amstrad £1.99cs ● Spec-  
trum £1.99cs

Originally released by Ariolasoft at full price, but now available for a fraction of that from Firebird. It's a horribly addictive game played on a 6x6 grid - either one or two player - in which you attempt to connect four counters, horizontally, vertically or diagonally.

★ ACE CLASSIC

## XOR

Logotron ● BBC £9.95cs  
£12.85dk ● Amstrad  
£9.95cs £14.95dk ●  
Spectrum £7.95cs

Extremely tricky maze game involving the player

controlling two shields, and collecting masks through 15 mazes, which increase in complexity as you progress. Also in later stages, fish and chickens lie in wait, often blocking the masks and just waiting

to fall on you and bring your quest to a premature end. Later still, things hot up as bombs, transporters and dolls conspire against you. Smooth scrolling, simple graphics, this one requires planning

# SPECIALS

Original works that are simply unclassifiable feature in this section.

## ATF

Digital Integration ● C64  
£8.95cs £12.95dk ●  
Amstrad £8.95cs  
£12.95dk ● Spectrum  
£8.95cs £13.95dk

Excellent combat/flight simulator that's a bit of a change for Digital Integration, the simulation specialist. The emphasis is on solid action, the result being a sure-fire hit.

★ ACE RATED 956 - SPECTRUM

## DARK SIDE

Incentive ● C64 £9.95cs  
£14.95dk ● Amstrad  
£9.95cs £14.95dk ●  
Spectrum £9.95cs  
£14.95dk

The second game using the Freescape programming system, which sets more of an arcade challenge. The 3-D graphics are again superb as are the tasks and puzzles.

★ ACE RATED 915 - AMSTRAD

## ELITE

Firebird ● C64 £14.95cs  
£17.95dk ● Amstrad  
£12.95cs £14.95dk ●  
Spectrum £14.95cs ●  
BBC £13.95cs £14.95dk  
(available from Superior  
software)

Still the best space trading game, Elite set a standard for other companies to follow. One of the first space games to use vector graphics, it's a shooting and trading effort set across several galaxies, with plenty of variety to the game play. You can trade legal goods in (relatively) safe systems, or run the gauntlet of pirates in the galaxies' danger spots with your hold full of contraband. Either way

there's a nice line in zero-G dogfighting, and as big a task as you'll find anywhere.

★ ACE CLASSIC

## INCREDIBLE SHRINKING SPHERE

Electric Dreams ● C64  
£8.99cs £14.99dk ●  
Amstrad £9.99cs  
£14.99dk ● Spectrum  
£9.99cs £14.99dk ● Atari  
ST £19.99dk ● Amiga  
£24.99dk

A manic maze world where mass, size and inertia combine to provide wicked gameplay. Tricky puzzles and endless nasty obstacles will have you rolling around in delight.

★ ACE RATED 923 - C64

## M1 TANK PLATOON

Microprose ● PC  
£39.99dk

This is a welcome break from flight-sims that boasts enough detail to keep even the most compulsive nitpicker happy, and at the same time has a breadth of challenge and combat scenarios that should satisfy the most ardent gamer. A winner.

★ ACE RATED 926

## MAGNETRON

Firebird ● C64 £8.95cs  
£12.95dk ● Spectrum  
£8.95cs £12.95dk

Puzzles and action Steve Turner style. Save the world by dismantling eight satellites. Steal parts from enemy droids to upgrade your own droid and hopefully make your job a little easier. The ideal game for Quazatron fans looking for a similar, new challenge.

★ ACE RATED 904 - SPECTRUM

## QUEDEX

Thalamus ● C64 £9.95cs  
£14.95dk

In this impressively challenging game you must steer a metallic ball through ten different screens of mazes, bonuses and obstacles, all within a set time limit. This simple game concept has a host of added features to make it particularly pleasing: you can carry over unused time to the next screen, for example, and tackle the different screens or 'planes' in any order you wish. Excellent graphics and utterly absorbing play.

★ ACE RATED 934 - C64

## SPINDIZZY

Electric Dreams ● C64  
£9.95cs £14.95dk ●  
Spectrum £9.95cs ●  
Amstrad £9.95cs £14.95  
Disk

Tremendous stuff; steer your spinning top over tough obstacles and collect jewels, against a fiendish time limit. The game landscape is a vast system of catwalks, ramps, towers and trampolines surrounded by lethal drops - and NO safety rails. Floor switches activate lifts and bridge traps, but tripping them in the right order can be harder than it looks. A few bad guys and a lot of nice touches, but the explosions the thing.

★ ACE CLASSIC

## STARGLIDER II

Rainbird ● Atari ST  
£24.95dk ● Amiga  
£24.99dk

One of the finest examples of a game using vector graphics to their full advantage, gets the solid 3D treatment and comes out looking every bit a winner. You've got a large task to complete and there's plenty of Egron's to destroy, making this combination of blasting and exploration that stands head above the competition.

★ ACE RATED 927 - ST

## STAR TREK V

Mindscape ● PC  
£34.99dk ● MAC  
£34.99dk

This is easily the best interpretation of Star Trek yet. The gameplay provides absorbing and challenging hours of fun. A must for Trekkies and an entertaining space strategy/simulator for everyone else.

★ ACE RATED 930

## TAU CETI/ACADEMY

CRL ● C64 £9.95cs  
£14.95dk ● Amstrad  
£9.95cs £14.95dk ●  
Spectrum £9.95cs ● Atari  
ST £19.99dk ● Amiga  
£19.95

Flight simulator/shoot 'em up and its sequel which are both incredibly smooth and well put together. The attention to detail is impeccable as you set off on hair-raising missions as a space cadet. In Academy you get to design your own space skimmer craft as well.

★ ACE CLASSIC

## TOTAL ECLIPSE

Incentive ● C64 £9.95cs  
£12.95dk ● Amstrad  
£9.95cs £12.95dk ●  
Spectrum £9.95cs  
£14.95dk

The third game using the Freescape system is a bit of a departure from the first two, but it's still an incredible game. In total eclipse you're battling against time back in the 1930's trying to prevent the moon exploding. For arcade adventurers who love puzzles, the Freescape system is a godsend.

★ ACE RATED 907 - AMSTRAD

## WIZBALL

OCEAN ● C64 £8.95cs  
£14.95dk ● Amstrad  
£8.95cs \$12.95dk ●  
Spectrum £8.95cs  
£14.95dk

Become Wizball and conquer the 'colour creatures' which are intent on eliminating the spectrum and rendering the landscape grey and drab. One of the most playable games around, despite the simple scenario.



## RPG

Role-playing games have exerted an enormous influence on modern game-styles. They combine the atmosphere of text adventures with the action of arcade games and the brain exercise of strategy – but their graphical presentatio tends to be weaker than other game genres. Gameplay centres around developing characters by raising their experience and skill levels in conflict with other, computer-controlled nasties. All that – and a quest too....

### THE BARD'S TALE II

Electronic Arts, C64  
£16.95, Amiga £24.95dk

The highly successful predecessor to Bards Tale III. BT II has the advantage of being slightly easier to advance. The Amiga version features some very nice sampled monk chants when you enter a temple and excellently coloured graphics. And of course, you can update your favourite characters, their attributes and equipment for use in BT III.  
★ ACE RATED 920

### THE BARD'S TALE III

Electronic Arts ● C64  
£14.95dk

The latest *Bard's Tale* game offers a number of refinements over its predecessors (all of which are still well worth taking a good look at). First, the graphics are better animated. Second, there are ranged combat routines which take careful account of the distance between you and your opponents. Finally, the game's large and represents excellent value for money.  
★ ACE RATED 920

### BATTLETECH

Infocom, PC £29.95, ST

Battletech features some incredible cartoon sequences, arcade style action, role play and strategy. In short a com-

plete, full game. A brilliant RPG purchase even though it missed out on an Ace rating.  
★ ACE RATED 801

### DUNGEON MASTER

Electronic Arts ● C64  
£14.95dk

Quoted as being a "milestone in Advanced Computer Entertainment", *Dungeon Master* offers 14 levels, loads of spells, atmospheric graphics and sound. All going to make *Dungeon Master* one of the best roleplaying adventures to have appeared on any machine.  
★ ACE RATED 949

### POOL OF RADIANCE

US GOLD /SSI  
● C64 £14.99dk

SSI were very brave to attempt to capture the complex concept of the AD&D system on a computer, but they managed superbly. An RPG-influenced game that will appeal to not only AD&D fans but to anyone looking for an enthralling game that will keep them playing for months.  
★ ACE RATED 921

### ULTIMA V

OriginSystems/Microprose  
● C64 £24.95dk ● PC £29.95 ● ST/Amiga to be announced

Astonishing level of detail in this role-playing

influenced epic. Travel round Britannia trashing the opposition and learning the magical, tactical, and geographical secrets that will enable you to defeat the forces of evil far underground. Superb

romp, great lasting interest, and tough challenges galore.  
★ ACE RATED 928

### WASTELAND

Electronic Arts ● C64  
£14.95dk

Charge around irradiated USA whopping mutant bunnies and biker scum in this role-playing epic. The atmosphere may not be as good as the *Bard's Tale* series of games, but

the extra dimension of strategy leaves the cut, slash and spell scenario of the *BT* series way behind.  
★ ACE RATED 921

## BRAIN GAMES

Fed up with mindless blasting? Want a game that offers you an opponent who's worthy of your skills? Then this is your section...

### CHESS MASTER 2000

Electronic Arts ● C64  
£9.95cs £14.95dk ● Amiga £24.95dk ● Atari ST £24.95dk ● IBM PC £24.95dk

Strongest chess game on the Amiga, with excellent graphics, 2D or 3D viewpoint, 12 levels of difficulty and all the playing options you could wish for. Plus some fairly nifty speech synthesis.  
★ ACE CLASSIC

### COLOSSUS CHESS 4

CDS ● C64 £9.95cs  
£14.95dk ● Amstrad £9.95cs £14.95dk ● Spectrum £9.95

Best bet for 8-bit machine owners, with a choice of 2D or 3D view, umpteen levels of difficulty, and a

myriad options which enable you to play, watch, work out chess problems, etc against a fine computer opponent.  
★ ACE CLASSIC

### COLOSSUS MAH JONG

CDS ● C64 £9.99cs  
£14.99dk ● Amstrad £9.99cs £14.99dk

Rummy-like oriental game of strategy and chance. A tutor program and a short manual make this an easy to use and highly entertaining piece of software for veterans and novices alike..  
★ ACE RATED 937 - C64

### INFOGRAMS' BRIDGE

Infogrames ● Amstrad £12.95cs £15.95dk ● MSX £12.95

Graphically the best of all contract bridge simulations, with large playing cards depicted against a suitably green baize background. Plays a good game (for a computer, which after all is a bit short in the imagination and flair department), and features a wide range of options and bidding conventions which you can toggle of according to your style.  
★ ACE CLASSIC

### POWERPLAY

Arcana ● C64 £8.95cs  
£14.95dk ● Amstrad £8.95cs £14.95dk ● Amiga £19.95dk ● Atari ST £19.95dk

If you want to try out your general knowledge, we reckon you'd be better off with this original and challenging combination of

strategy game and quiz than with the admittedly monster selling Trivial Pursuits. *Powerplay* is graphically very pretty in its setting on Mount Olympus, home of the Gods.  
★ ACE RATED 935 - Amiga

### SCRABBLE

Leisure Genius ● C64  
£12.95cs £14.95dk ● Amstrad £9.95cs £14.95 ● IBM PC £24.95dk

The hugely popular word game translated very successfully onto the micro. Fast, excellent display, and a suprisingly large vocabulary (even if it does include some strange looking words on some occasions). Good enough to give even strong human opponents a tough game at the higher levels.

## WAR GAMES

Fancy yourself as a master of grand strategy, marshalling hordes of troops and sending them of to do battle on your behalf? Look no further than the ACE war games section...

### ARNHEM

CCS, Spectrum £8.95cs,  
Amstrad £9.95cs, C64 £9.95cs

One of the oldest quality wargames featured in the section, Arnham was easily the best in the field. It has all the expected atmosphere, five separate scenarios and one of the toughest computer opponents you could ever wa't to meet. A thoroughly absorbing wargame which can be classed as one of the old masters.  
★ ACE RATED 910

### CONFLICT EUROPE

Mirrorsoft, ST 24.99,  
Amiga £24.99, PC TBA

The 16 bit progression of Theatre Europe. Lots of extra graphical and sound effects. The computer controlled intelligence was marginally sophisticated but still enough to give a challenging game. The correct balance between strategy and excitement throughout. Great for beginners and intermediate players.  
★ ACE RATED 882

### THEATRE EUROPE

PSS, Spectrum £9.95cs,  
C64 £0.95cs £14.95dk,  
Amstrad £9.95cs  
£14.95dk

The perfect game for 8 bit owners who go green with envy when they look at Conflict Europe. Theatre Europe is the forerunner to the excellent 16 bit game. The graphics and overall play are not as sophisticated, but on the whole it still is one heck of a game.  
★ ACE RATED 915

### UMS

Rainbird, ST £24.95, PC  
£24.95, Macintosh  
£34.95, Amiga £24.95

Probably the greatest war game to date. UMS' unique 3D systems enables the creation of almost any battle in history. As well as a very sophisticated computer opponents yet. On top of this are add on scenarios and a very neat construction kit to keep you going for even longer. An essential purchase  
★ ACE RATED 907



# SPEEDY SERVICE

1-7 College Street  
Northampton  
NN1 2SZ  
TEL: 0604 33922  
FAX: 0604 24664

## TOP 85

	AMIGA	ST
01. Archon Collection	£6.99	—
02. Artic Fox	£6.99	—
03. A.P.B.	£13.99	£13.99
04. Astaroth Angel of Death	£17.50	£17.50
05. Blood Money	£17.50	£17.50
06. Bloodwych	£17.50	£17.50
07. Bards Tale 1.	£6.99	£6.99
08. Bards Tale 2.	£17.50	—
09. Battle Chess	£17.50	£17.50
10. Bionic Commandos	£6.99	£6.99
11. Balistix	£13.99	£13.99
12. Beach Volley	£17.50	£13.99
13. Batman The Movie	£17.50	£13.99
14. Castle Warrior	£17.50	£13.99
15. Dungeon Master	£17.50	£17.50
16. Dragon Ninja	£17.50	£13.99
17. Demons Winter	£17.50	£17.50
18. Double Dragon	£13.99	£13.99
19. Dynamite Dux	£13.99	£13.99
20. Deluxe Paint II	£55.00	—
21. Elite	£17.50	£17.50
22. F16 Combat Pilot	£17.50	£17.50
23. Falcon (Mirrorsoft)	£20.99	£17.50
24. Falcon Mission Disk	£13.99	£13.99
25. Forgotten Worlds	£13.99	£13.99
26. Foundations Waste	£6.99	£6.99
27. F.O.F.T.	£20.99	£20.99
28. Fantavision	£27.99	p.o.a.
29. Flight Simulator 2	£24.50	£24.50
30. Fiendish Freddy's	£20.99	£20.99
31. Gemini Wing	£13.99	£13.99
32. Gunship	£17.50	£17.50
33. Indiana Jones (Arcade)	£13.99	£13.99
34. Journey	£20.99	—
35. Jet	£24.50	£24.50
36. Kick Off	£13.99	£13.99
37. Kult	£17.50	£17.50
38. Kings Quest Triple Pack	£24.50	24.50
39. Knight Force	£17.50	£17.50
40. Lords of the Rising Sun	£20.99	—
41. Leonardo	£13.99	£13.99
42. Mr Heli	£17.50	£17.50
43. Millennium 2.2	£17.50	£17.50
44. Microprose Soccer	£17.50	£17.50
45. Marble Madness	£6.99	£6.99
46. Manhunter	£20.99	£20.99
47. New Zealand Story	£17.50	£13.99
48. Out Run	£6.99	£6.99
49. Phobia	£17.50	£13.99
50. Paperboy	£13.99	£13.99
51. Populous New Worlds	£6.99	£6.99
52. Populous	£17.50	£17.50
53. Passing Shot	£13.99	£13.99
54. Quest for the Time Bird	£20.99	£20.99
55. Rainbow Islands	p.o.a.	p.o.a.
56. Real Ghostbusters	£17.50	£17.50
57. Rick Dangerous	£17.50	£17.50
58. Robocop	£17.50	£13.99
59. RVF Honda	£17.50	£17.50
60. Rocket Ranger	£20.99	£17.50
61. Running Man	£17.50	£17.50
62. Shinobi	£13.99	£13.99
63. Strider	£13.99	£13.99
64. Super Wonderboy	p.o.a.	p.o.a.
65. Shadowgate	£17.50	£17.50
66. Street Fighter	£6.99	£6.99
67. Sky Fox 2.	£6.99	£6.99
68. Story so Far Vol 1.	£13.99	£13.99
69. Story so Far Vol 2.	£13.99	£13.99
70. Spherical	£13.99	£13.99
71. Speedball	£17.50	£17.50
72. Silkworm	£13.99	£13.99
73. Star Wars Trilogy	£17.50	£17.50
74. Shadow of the Beast	£24.50	p.o.a.
75. Triad 2.	£17.50	£17.50
76. Targhan	£17.50	£17.50
77. 3D Pool	£13.99	£13.99
78. Thunderbirds	£17.50	£17.50
79. Time and Magick	£13.99	£13.99
80. TV Sports Football	£20.99	£17.50
81. Vigilante	£10.50	£10.50
82. Waterloo	£17.50	£17.50
83. War in Middle Earth	£13.99	£13.99
84. Weird Dreams	p.o.a.	£17.50
85. Worldclass Leaderboard	£6.99	£6.99
86. Xenon II	£17.50	£17.50
87. Captain Blood	£6.99	£6.99
88. Fun School 2 under 6	£13.99	£13.99
89. Fun School 2 6-8 years	£13.99	£13.99
90. Fun School 2 8 overs	£13.99	£13.99

91. Operation Thunderbolt	p.o.a.	p.o.a.
92. Continental Circus	£13.99	£13.99
93. F/A 18 Interceptor	£17.50	—
94. Leisuresuit Larry 2	—	£20.99
95. Police Quest	£13.99	£13.99
96. Police Quest 2	£13.99	£17.50
97. Space Quest 2	—	£20.99
98. Phoenix	—	£6.99
99. Turbo GT	—	£6.99
100. TNT	—	£6.99
101. Solomons Key	—	£6.99
102. Centrefold Squares	£13.99	£13.99
103. Hard Drivin	p.o.a.	p.o.a.
104. Power Drift	£17.50	£17.50
105. Cabal	p.o.a.	p.o.a.
106. F29 Retaliator	p.o.a.	p.o.a.
107. Ivanhoe	p.o.a.	p.o.a.
108. Untouchables	p.o.a.	p.o.a.
109. It Came from the Desert	p.o.a.	p.o.a.
110. Space Ace	£31.49	£31.49
111. Keef the Thief	£17.50	p.o.a.
112. North and South	£17.50	£17.50
113. Nigel Mansell	£6.99	£6.99
114. Barbarian I	£6.99	£6.99
115. Dungeon Master Editor	£6.99	£6.99
116. Light Force	£17.50	£17.50
117. Balance of Power	£17.50	£17.50
118. Chaos Strikes Back	p.o.a.	p.o.a.
119. Faery Tale	£13.99	p.o.a.
120. Fusion	£6.99	—
121. Battle Squadron	£17.50	—
122. Tin Tin	£17.50	£17.50

p.o.a. = Phone on Availability

## \*\*\*\*\*XMAS SPECTACULAR\*\*\*\*\*

ONLY AVAILABLE FROM SPEEDY SERVICE

Amiga Mouse, PSU, 3 Start Up Discs,	
3 Manuals	£399.99
T.V. Modulator	£24.99
Batman the Movie	£24.99
New Zealand Story	£24.99
FA/18 Interceptor	£24.99
Deluxe Paint 2	£49.99
Amegas, Art of Chess, Barbarian, Rugby Boy,	
Ikari Warriors, Insanity Fight, Mercenary 1-2,	
Terrorpods, Thundercats, Wizball	£230.00
Photon Paint	£69.99
Slayer	£24.99
Battle Valley	£24.99
Zynaps	£19.99
Exolon	£19.99
Cyberoid 2	£24.99
Joystick	£6.99

Retail Rec. Price.....£971.87  
Speedy Service Price .....£399.99  
Next Day Delivery only £10.00

**1 Meg Amiga Upgrade  
+ on/off Switch,  
no internal Clock  
+ Free Dungeon Master  
ONLY £84.99**



**ALL PRICES INC. VAT  
+ Subject to Availability  
+ Post and Packaging**



Prices correct at time of going to Press. Subject to change Without Notice.

**1000's** More Titles Available  
of Satisfied Customers  
**24 HR DESPATCH**

## \*\*\*\*\* DISCS \*\*\*\*\*

10 3.5	£6.00
50 3.5	£30.00
100 3.5	£57.50

## \*\*\*\*\* LABELS \*\*\*\*\*

10 Labels	£0.20
50 Labels	£1.00
100 Labels	£1.75
250 Labels	£4.00

## \*\*\*\*\* STORAGE BOX \*\*\*\*\*

10 DDL	£2.00
40 DDL	£6.00
80 DDL	£8.00

## \*\*\*\*\* BITS AND BOBS \*\*\*\*\*

Mouse Mats	£3.00
Mouse Houses	£1.99

PHONE FOR MORE GOODIES

## \*\*\*\* POCKET MONEY SOFTWARE \*\*\*\*

.....Amiga	.....ST
Kelly X	£4.00
Kickstart II	£4.00
Little Computer	—
People	£4.00
Motorbike	£4.00
Madness	£4.00
Pub Pool	£4.00
Roadworks	£4.00
Sorcery +	£4.00
Speedboat	£4.00
Assains	£4.00

## \*\*\*\*\* AUTHORISED \*\*\*\*\*

### GOLD STAR DEALERS

\*\*\*\*\*

## SPECIAL OFFERS

Star LC10 + Free Cable ..... £150.00  
(whilst Stocks Last)

Star LC10 Colour-Free Cable  
+ Free Ribbon ..... £205.00

Star LC24/10 + Free Cable  
24pin/LQ/DRAFT ..... £245.00

Star 24/15 + Free Cable  
24pin 132 col ..... £399.00

Star LC10/2 + Free Cable  
Limited Stocks ..... £205.00



# FLIGHT SIMULATIONS

How about flying the latest US Stealth Fighter on a mission over Siberia? Or perhaps a quick flight over Hawaii would be more relaxing? Computer flight simulations can fulfill any flight of fancy

## BATTLE-HAWKS 1942

Lucasfilm Games/US Gold  
● ST £24.95dk ● Amiga  
£24.95dk ● PC £24.95dk

A WWII NAVAL AIR COMBAT SIMULATOR COVERING THE FOUR MOST IMPORTANT BATTLES OF THE 1942 PACIFIC WAR. FOR KNUCKLE-WHITENING ACTION THIS ONE HAS EVERYTHING - THE SENSE OF 'BEING THERE' IS TREMENDOUS. THRILLING AND SURPRISINGLY ADDICTIVE STUFF.

★ ACE RATED  
928

## BOMBER

Activision ● Spectrum  
£14.99cs £19.99dk ●  
C64 £14.99cs £19.99dk  
● Amstrad £14.99cs  
£19.99dk ● ST £24.99dk  
● Amiga £24.99dk ● PC  
£34.99dk

Vector Grafix has spent a long time on this one - and it certainly shows. The game gets the balance just right between convincing simulation and entertaining game. Highly recommended.

★ ACE RATED  
925

## CHUCK YEAGER'S ADVANCED FLIGHT TRAINER

Electronic Arts ● Spectrum ● C64 ● CPC ● ST  
● Amiga ● PC £24.95dk

Fly a multitude of aircraft from an early bi-plane to the Space Shuttle. It's entertainingly different from your standard flight sim and there's so much in this game that it will take many hours of instructive fun to experience and master all the available options.

★ ACE RATED  
912

## F-16 COMBAT PILOT

Digital Integration ● ST  
£24.95dk ● Amiga  
£24.95dk ● PC £24.95dk

This took nine person years to develop, and you can feel that quality of work when playing it - it's one of the most realistic flight sims on the market. If you are a connoisseur of flight simulators then this is an essential addition to your collection.

★ ACE RATED  
970

## FALCON

Spectrum  
Holobyte/Mirrorsoft ● ST  
£24.95dk ● Amiga  
£24.95dk ● PC £24.95dk  
● MAC

If you really want the terror, exhilaration and

sheer everything-happens-at-once confusion of combat flying, this game delivers. Make no mistake, this game is the real thing. An essential purchase for fast-jet fans.

★ ACE RATED  
945

## FLIGHT SIMULATOR II

Sublogic ● C64  
£39.95dk ● ST £49.95dk  
● Amiga £49.95dk ● PC  
£49.95dk ● MAC  
£49.95dk

The flight sim that put the genre on to the map. Thoroughly realistic flight sim of a domestic Cessna plane, which is even used by flight schools to train

would be pilots. Can be enhanced by a variety of Scenery Disks.

★ ACE CLASSIC  
**INTERCEPTOR**  
Electronic Arts ● Amiga  
£24.95dk

A low level flight sim with a hi-level of fun. Purists may dispute the label 'simulator' - it certainly wouldn't train you to fly a real life Hornet - but this program combines realism and gameplay far too well for that to matter. If you want seat-of-the-pants air combat action, miraculous graphics and NO six month training period, look no further!

★ ACE RATED

# RACING SIMULATIONS

In You can't have too much of a good thing, even if the excitement is liable to give the old ticker a good going over. Racing sims have really come into their own over the past couple of years - and this is where you find out how to get the best of motor racing action - all from the comfort of that armchair in front of your computer....

## LOMBARD RAC RALLY

Mandarin ● ST ● Amiga  
● PC

Race through many types of terrain, such as mountain or forest, and through many types of weather condition, such as fog or night. The game has a nice atmosphere, and though the variety of gameplay may be a little low, it's still a game you'd be playing for a good while.

## FERRARI FORMULA ONE

Electronic Arts ● ST  
£24.99dk ● Amiga  
£24.99dk ● PC £24.99dk

A bit old this one, but still a game that was way

ahead of its time to start with. Take the wheel of a Formula One Ferrari racer on some of the most famous racecourses in the world. A true thoroughbred.

## R.V.F.

Microstyle ● ST £24.99dk  
● Amiga £24.99dk

The champion in the Best Sprite Based Racing Game stakes, and a superb simulation, this one puts you into the world of performance bike racing on none other than the Honda RVF750. Brilliant graphics, brilliant sound, brilliant game.

## STUNT CAR RACER

Microstyle ● Spectrum

£9.99cs £14.99dk ● C64  
£9.99cs £14.99dk ● ST  
£24.99dk ● Amiga  
£24.99dk ● PC £24.99dk

This places itself in the annals of computer history as being one of the most amazing spectacles to watch, let alone play. The game is first-person perspective, with the outside world made up of really fast smooth filled vectors, and the impression of realism is unbelievable. An amazing experience, and a clear winner. Where can things go from here?

## SUPER HANG ON

Electric Dreams ● Spectrum  
£9.99cs ● C64  
£9.99cs £14.99dk ●  
Amstrad £9.99cs  
£14.99dk ● ST £24.99dk

● Amiga £24.99dk

Not so much a simulation as a perfect arcade conversion of a brilliant bike racing Sega coin-op. Great game, excellent conversion.

## THE DUEL - TEST DRIVE II

Accolade ● C64 ● ST ●  
Amiga ● PC ● MAC

Accolade tried to right all the Test Drive wrongs with this sequel, and to an extent they succeeded. There's nothing serious about the game. It's just a lot of fun. It doesn't claim to be technically or visually accurate, but why should it?

## THE ARSENAL

This may not be the place to say it, but it's got to be said and there's a wee space here, so why not? Arsenal are finished. This may not matter to you, but here in the ACE office it's an issue of great importance. You see, ACE's ebullient, bullish etc. ad manager, Gary Williams is an Arsenal season ticket holder (let's just pass over the fact that Gary comes from Blackpool). Last May he was cock-a-hoop, as Michael Thomas scored the last minute goal at Anfield that secured the league championship.

Well, eat your heart out Gary Williams. As I write it is a mere 18 hours since Arsenal were soundly beaten by Liverpool at Anfield. It's only a few days since they were hammered 3-1 by lowly Oldham Athletic (and not even George Graham could blame it on the plastic pitch).

Is this the end of Arsenal? Should Gary Williams trade his season ticket at Highbury for a place on the terraces at Boundary Park, famous home of the famous 'Latics? Watch this space....





# Computer Adventure World



WE SPECIALISE IN BRITISH/IMPORTED SOFTWARE for ST AMIGA IBM C64 APPLE

## ADVENTURES-FANTASY-WARGAMES-STRATEGY

OUR NEW STORE AND  
MAIL ORDER ADDRESS:

318 Kensington, Liverpool. L7 0EY

Telephone : [051] 263 6306.

LOTS OF HARDWARE & SOFTWARE BARGAINS AVAILABLE AT BOTH STORES !!!

ALTHOUGH WE SPECIALISE IN "STRATEGY - STYLE" SOFTWARE WE STOCK JUST ABOUT EVERYTHING FOR COMPUTERS INCLUDING: SOFTWARE: AMSTRAD CPC - APPLE II - ATARI ST & 8 BIT - BBC & ELECTRON - COMMODORE AMIGA & C64 IBM COMPATIBLES BOTH 5.25" & 3.5" - MSX - SPECTRUM - SEGA & ATARI VIDEO GAMES

HARDWARE: AMSTRAD PC/PCW/ CPC - ATARI PC/ ST - ACORN - COMMODORE PC/AMIGA/ C64 - DISKDRIVES CITIZEN & STAR PRINTERS - PHILIPS MONITORS AND TV'S - SEGA SYSTEMS - AND MORE!!!

ACCESSORIES: BLANK DISCS & BOXES - PRINTER RIBBONS & PAPER - LEADS - COVERS - STANDS - JOYSTICKS

### LATEST TITLES: INCLUDING IMPORTS FROM THE USA:

- SIM CITY ... DESIGN, BUILD & RUN THE CITY OF YOUR DREAMS: GREAT GRAPHICS & DETAIL: ... IBM/AM IMeg ..... £39-50
- SPACE ROGUE .... GREAT STRATEGIC & ACTION GAME IN THE 'ELITE MOULD': GRAPHICS & DETAIL ... IBM/C64 .... £39-50
- THE MAGIC CANDLE ... LARGE SCALE 'ULTIMA STYLE' GRAPHIC PARTY RPG: DETAILED WORLD ... AM/IBM/C64 ... £32-50
- POOLS OF RADIANCE .. GREAT FANTASY RPG: COMPLETE WITH SSI/TSR'S MAPPED HINT BOOK .. ST/AM/IBM/C64 .. £29-50
- CURSE OF AZURE BONDS ... SEQUEL TO "P OF R" ABOVE: COMPLETE WITH THE OFFICIAL HINT BOOK .. IBM/C64 .... £29-50
- ULTIMA V ... AT LAST! THE BIGGEST & BEST YET: COMPLETE WITH ORIGINS DETAILED HINT BOOK .. ST/AM/IBM ... £29-50
- UNIVERSE III ... OMNITREND'S LARGE 'GRAPHIC QUEST RPG': ANIMATED COMBAT: ZOOM FEATURE .. AM/ST/IBM ... £32-50
- STAR SAGA II .... SEQUEL TO I-SAME PRICE-MASSIVE & UNIQUE INTERACTIVE ONE/MULTIPLAYER QUEST ... IBM ... £65-00
- STAR COMMAND . LOTS OF DETAIL. IN THIS LARGE 'SPACE RPG': MINI-QUESTS & TACTICAL COMBAT ST/AM/IBM £27-00
- MIGHT & MAGIC II ... HUGE FANTASY GRAPHIC PARTY RPG: DETAILED WORLD: MANY QUESTS .. IBM/C64/APPLE .. £39-95
- PROPHECY ... GRAPHIC RPG: 28 CHARACTERS-60 WEAPONS-7 DUNGEON LEVELS-GREAT 'MAGIC' ... IBM SO FAR ... £32-50
- SWORD OF ARAGON ... FANTASY STRATEGY WARGAME: EXPAND YOUR KINGDOM-DEVELOPE COMMERCE AND AGRICULTURE-PAY TROOPS-EVEN NAME YOUR UNITS-TACTICAL COMBAT .. IBM SO FAR .. £27-00
- OMEGA .. DESIGN, IMPROVE AND OPERATE THE ULTIMATE 'CYBERTANK': HIGHLY DETAILED . AM/IBM/APP/C64 .. £37-50
- FIRE BRIGADE ... DETAILED GRAPHIC ARMORED COMBAT AT KIEV IN WWII: ST DUE SOON-NOW FOR IBM/AM ..... £27-00
- GHENGIS KHAN .. FROM 'KOEI' OF JAPAN: EXCELLENT STRATEGY, RPG AND WARGAME OF ANCIENT CONQUEST: COMMERCE, BRIBERY, SUBVERSION, TACTICAL COMBAT FEATURE: LOTS OF ATMOSPHERE . IBM £49-50
- EMPIRE OF 3 KINGDOMS .. ANOTHER HIGHLY DETAILED GAME FROM 'KOEI' OF THE UNIFICATION OF CHINA IBM £49-50
- ARMADA ... DETAILED TACTICAL NAVAL COMBAT FROM AUTHOR OF 'WATERLOO/ BORODINO': DUE NOW ON ST . £27-00
- EMPIRE ..... GREAT STRATEGIC GAME OF GLOBAL CONQUEST INC PROD'N .. AM/ST/IBM. £24-50 : FROM USA C64 ... £32-50
- STARFLEET II ... LARGE SCALE DETAILED GALACTIC WARGAME: PLANETARY INVASIONS & MORE .. IBM SO FAR .. £39-95
- 2400 AD .... FROM 'ORIGINS' (OF ULTIMA FAME) FUTURISTIC GRAPHIC ADV/RPG WITH MANY LOCATIONS .. IBM .... £29-50
- MICROLEAGUE BASEBALL II ... "THE" TOTAL BASEBALL SIMULATION INC. MANAGEMENT & LEAGUE ... ST/IBM .... £42-50
- NFL CHALLENGE ... HIGHLY DETAILED & COMPREHENSIVE US FOOTBALL SIMULATION: NFL APPROVED ... IBM ..... £65-00
- MSFL ..... COMPLETE GRAPHIC US FOOTBALL SIMULATION FOR IBM .... £39-50 : DATA & TEAMS DISC FOR MSFL ..... £25-00
- JOHN ELWAYS QUARTERBACK .... GRAPHIC REAL TIME GAME WITH LOTS OF PLAYS AND ACTION ..... IBM/C64 ..... £29-50
- PURE STATS FOOTBALL .... SPLIT SCREEN DETAILED 'US' SIMULATION INCLUDING THE 86 SEASON TEAMS .. C64 ... £32-50
- SUPER SUNDAY ... AVALON HILL'S COMPREHENSIVE US FOOTBALL SIM. FOR IBM/APP/C64 .. £29-50: TEAMS DISC .. £20-00
- LATEST SIMULATIONS CANADA' 1 OR 2 PLAYER COMPUTER MODERATED BOARD WARGAMES INCLUDING MAPS ETC:
- GRAND FLEET .... 'DREADNOUGHT CONFLICT' PRE & POST WWI IN THE ATLANTIC: INC. DIY SCENARIOS .. ST/IBM .. £35-00
- KREIGSMARINE .... SEQUEL TO GRAND FLEET: NAVAL CONFRONTATION IN THE ATLANTIC IN WWII ..... ST/IBM ..... £35-00
- NORTHERN FLEET .... MODERN NAVAL COMBAT IN THE NORTH ATLANTIC: MANY SCENARIOS & DIY ..... ST/IBM .... £35-00
- MBT ... 'MAIN BATTLE TANK' MODERN DETAILED OPERATIONAL LEVEL ARMORED COMBAT IN EUROPE . ST/IBM £35-00

### LATEST OFFICIAL 'HINT & SOLUTION' BOOKS: MANY IMPORTED TITLES:

- QUEST FOR CLUES II: 40 DETAILED & MAPPED SOLUTIONS BOOK FROM 'ORIGINS' INCLUDING:
- POOLS OF RADIANCE-ULTIMA V-MANHUNTER NY-STAR COMMAND-TIMES OF LORE-SPACE QUEST II & MORE ..... £18-50
- ULTIMA V .. £8-95 : AZURE BONDS OR POOLS OF RADIANCE.. £7-95 EACH : KINGS QUEST I, II, III, OR IV .. £7-95 EACH
- MANHUNTER NY .. £8-95 : SPACE QUEST I OR II .. £7-95 EACH : POLICE QUEST I OR II .. £7-95 : L. SUIT LARRY .. £8-95
- BARDS TALE I, II OR III . £6-95 EACH : MIGHT & MAGIC I OR II . £10-50 : WASTELAND . £7-95 : MANY MORE AVAILABLE!

**SEND LARGE 38p SAE FOR FREE DESCRIPTIVE CATALOG & DISCOUNT VOUCHER**

THIS DETAILS OUR 'SPECIALIST GAMES' & MORE : PLEASE STATE YOUR COMPUTER FORMAT WHEN ORDERING.

PAYMENT : MASTERCARD/ACCESS-VISA-UK CHEQUE OR POSTAL ORDER-EUROCHEQUE-REGISTERED CASH  
POSTAGE : IN UK IS FREE - PER GAME EUROPE £2 & ELSEWHERE £5 : SENT 1ST. CLASS RECORDED /AIR MAIL



# Computer Adventure World

Bank Buildings, 1A Charing Cross, Birkenhead L41 6EJ

Telephone: 051-666 1132





# ACE DIARY

## INTO THE NEW DECADE

### DECEMBER RELEASES AT A GLANCE

PC:  
 Populous and Populous: Promised Lands (Electronic Arts). Highly acclaimed world manipulation game makes it on to the PC; offices everywhere should judder to a halt. Keef the Thief (Electronic Arts). Tongue-in-cheek graphic adventure, originally on Amiga/ST. Fireking (Electronic Arts). Stunt Car Racer (Micro Style). Galdregon's Domain (Pandora). Bruce Lee Lives (Mindscape). Amiga:  
 Neuromancer (Electronic Arts). Role playing adventure. Infestation (Psygnosis). Blast away in solid 3D. Hardball II (Accolade). Baseball sim sequel. Atari ST:  
 Infestation (Psygnosis, see above). All formats: Snoopy and the Case of the Lost Blanket (The Edge). Big cartoon licence - join Snoopy in the hunt for Linus's missing blanket. The Search for Sharla (Thalamus). Arcade adventure boasting hundreds of screens, characters, etc. Powerboat USA (Accolade, not CPC or Spectrum). Offshore powerboat simulation with various 'courses' from around the world.

### TUESDAY 12

Independence Day, Kenya

### WEEK'S RELEASES AT A GLANCE

Amiga: Battle of Austerlitz (PSS). Bloodwych Data Disk (Image Works). Starflight (Electronic Arts). Graphic adventure with fantasy/galactic scenario. Hound of Shadow (Electronic Arts). Role playing adventure cum horror yarn. Atari ST:  
 Hound of Shadow (Electronic Arts, see above). Battle of Austerlitz (PSS). Bloodwych Data Disk (Image Works). PC: Gold of the Americas (Electronic Arts). Interphase (Image Works). Arcade adventure with 3D filled vector graphics and bizarre plot. Wolfpack (PSS). Naval simulation set in the North Atlantic in World War II. Much attention lavished on authenticity and graphics. Dungeon Master (FTL). Acclaimed role playing game make sit on the PC. Flight of the Intruder (Spectrum Holobyte). Aerial combat game set during the Linebacker campaign in Vietnam, 1972. Harpoon (PSS). The Cold War lives on in NATO vs Warsaw pact game with you

controlling NATO task force in North Atlantic. C64:

Starflight (Electronic Arts, disk only, see above). Madden Football (Electronic Arts). Disk only, American Football simulation. Daily Double Horse Racing (CDS). Horse racing sim with betting. Converted down from 16-bit machines.

### FRIDAY 22

Shortest day of the year: sun rises at 8.04am, sets at 3.54pm.

### SATURDAY 23

Hanukkah: Jewish festival of lights

Is one of the wrapped shapes under the tree remarkably computer-shaped? Has it got your name on the gift-tag? If so, go out today and buy the following: mains plug, small headed screwdriver with a long handle, four-way electrical socket, blank disks/tapes. This way you won't have to take the plug off the kettle to set up the computer, or place it somewhere utterly inconvenient just so that you're near the double power point, etc.

### SUNDAY 24

Christmas Eve

### WEEK'S RELEASES AT A GLANCE

If any games are released this week it

will be an accident. It's turkey on Monday, reheated turkey leftovers after that, liqueur chocolates and James Bond movies on TV for everyone this week.

### MONDAY 25

Christmas Day

### TUESDAY 26

Boxing Day (Bank Holiday) St Stephen's Day

### THURSDAY 28

National Day, Nepal. Celebrate with some more turkey...

### FRIDAY 29

Feast Day of St Marcellus the Righteous, known as the "sleepless monk", because he decreed that hymns should be sung for 24 hours in his monastery. Any record of what the neighbours thought of this has not survived.

### SUNDAY 31

New Year's Eve and the end of the Eighties. Week's releases at a glance

### JANUARY 1990

New games going into the shops this week are likely to be titles which were intended for pre-Christmas release but didn't make it, due to unprecedented high demand, er, waiting for delivery of manuals, er, felt January offered a better 'window of opportunity' ... just

weren't finished or debugged in time.

### MONDAY 1

New Year's Day (Bank Holiday) Liberation day, Cuba National Day, Haiti Independence Day, Sudan

### TUESDAY 2

Bank Holiday in Scotland. Feast Day of St Basil the Great

### THURSDAY 4

Brave the rush to your newsagent: ACE February issue is out today. International Boat show begins. Independence Day, Burma

### FRIDAY 5

Feast Day of St Simeon the Stylite, famous because he spent the last 36 years of his life living on top of a 60ft pillar.

### SATURDAY 6

Epiphany

### WEEK'S RELEASES AT A GLANCE

Amiga: Deluxevideo III (Electronic Arts). Animation package with many enhancements over DVideo II, and complements Deluxepaint III. A hefty £79.99 though. Skate or Die (Electronic Arts). Skateboard simulation converted up from 8-bits. Dragon's Breath (Palace). One to three player strategy trading game developed by team whose members had varying degrees of involvement in

Populous. Space Harrier 2 (Grandslam). Elite did the original, but this is the all-new 1990 version. Wings of Fury (Domark). Aerial combat game licensed from Broderbund.

PC:  
 Indianapolis 500 (Electronic Arts). Fast racing sim (yetanother!) - based on Indianapolis 500 race, surprisingly enough. Samurai (Microprose). Atari ST:  
 Skate or Die (Electronic Arts, see above). Starflight (Electronic Arts, see above). The Duel: Test Drive II (Accolade). Lagging behind the other versions, this is the Ferrari F40 vs Porsche 959 episode in Accolade's growing Test Drive series. Also coming out now for ST are the accessory disks: California and European Challenge, Super Cars and Muscle Cars.

C64

F16 Combat Pilot (Digital Integration). First 8-bit version of one of the 16-bit raves of 1989. Flight'n'fight sim.

### SATURDAY 13

Feast Day of St Hilary of Poitiers, who gave his name to the Hilary Term in universities and courts of law.



# Special Reserve

- Bi-monthly **Buyer's Guide** each with details of 40 games.
- Membership card, Release Schedule and a folder for the Buyer's Guides.
- **24-hour despatch** of stock items. Most lines in stock.
- Games sent individually by **1st class post**. Most fit through your letter-box.
- **7-day hotline**, until 8pm weekdays, 10 to 5.30 Saturdays, 11 to 5 Sundays.
- **Written notification** of delays and instant refunds on request.
- **No commitment**, no obligation to buy anything and no "minimum purchase".
- **The best games, carefully selected, available at extraordinary prices.**

All for just **£5.00**

We're miles cheaper than elsewhere. Below are a selection of offers at prices you might not believe. You can buy games at the same time as joining - or join now and select from our full catalogue. All items advertised are only for sale to members and are subject to availability. Note: Upgrade to Official Secrets is offered to members of Special Reserve

Can you afford not to join?

For the serious gamer!

**Official Secrets**



Members of Official Secrets get all the benefits of Special Reserve plus:

• **Confidential.** Our 32 page bi-monthly magazine is essential reading for those interested in adventures or role playing games. Written by experts, Confidential has covered everything from How to Host a Murder to Which F16 Flight Simulator? Our agents, led by the Master Spy known as "The Boss Upstairs", seek out the secrets of RPG's, FRP's, MUG's, PBM's, Leisure Suit Larry, The Russians, Elvira....

• **Myth.** Written by Magnetic Scrolls, authors of The Pawn, exclusively for members of Official Secrets. Myth is a small adventure set in Ancient Greece. In it you'll meet The Ferryman, cheat Death and face the nine-headed Hydra. Myth includes the famous Magnetic Scrolls parser and graphics and is included in the price of membership.

• **Help-Line.** Manned weekdays until 8pm and Sundays. The Help-Line can help you solve most problems on most adventures.

• **Gnome Ranger.** Level 9's brilliant 3-part

adventure or a **Surprise Alternative.** Annual UK Membership costs **£22.00**, including six issues of Confidential, Myth, the Help-Line, Gnome Ranger and membership of Special Reserve.

## 16 Bit Software

AMIGA ST IBM			AMIGA ST IBM		
ALTERED BEAST	15.99	12.99	F16 COMBAT PILOT	15.99	15.99
AMERICAN ICE HOCKEY	15.99	15.99	F16 FALCON	15.49	14.99
AQUAVENTURA	19.99	19.99	F16 FALCON MISSION DISK	9.99	9.99
ARTHUR (INFOCOM)	16.49	19.99	F29 RETALIATOR	16.49	16.49
BAAL	6.99	6.99	FED OF FREE TRADERS	19.49	19.49
BALANCE OF POWER-1990	15.99	15.99	FERRARI FORMULA 1	15.49	15.49
BALLISTIX	6.99	6.99	FIENDISH FREDDIE'S BIG TOP	18.49	18.99
BANGKOK KNIGHTS	15.99	13.49	FIFTH GEAR	15.49	15.49
BARBARIAN 2 (PALACE)	18.49	15.49	FISH! (MAG SCROLLS)	13.99	13.99
BARBARIAN 2 (PSYGNOSIS)	14.99	14.99	FLASH DRAGON	12.49	12.49
BATMAN CAPED CRUSADER	15.49	12.99	FLYING SHARK	6.99	6.99
BATMAN THE MOVIE	15.99	15.99	FOOTBALL MANAGER 2	8.49	8.49
BATTLE SQUADRON	15.99	15.99	FM 2 EXPANSION KIT	5.99	6.49
BATTLECHESS	10.99	16.49	FUTURE WARS	16.49	16.49
BATTLETECH (INFOCOM)	16.49	16.49	GAUNTLET 2	16.49	13.49
BEACH VOLLEY	15.99	12.99	GHOSTBUSTERS 2	16.49	16.49
BLADE WARRIOR	15.99	15.99	GRIDIRON (U.S FOOTBALL)	14.99	14.99
BLOOD MONEY	14.49	14.49	GUNSHIP	15.99	15.49
BLOODWYCH	15.49	15.49	HARD DRIVEN	12.99	12.99
BLOODWYCH DATA DISK	9.99	9.99	HELLFIRE ATTACK	3.49	3.49
BOMBER	18.49	18.49	HEWSON PREMIER VOL1	16.99	16.99
CABAL	15.49	13.49	HEWSON PREMIER VOL2	17.49	17.49
CARTHAGE	15.49	15.49	HILLSFAR (SSI)	17.49	17.49
CASTLE WARRIOR	15.49	12.99	HIT DISKS VOLUME 2	9.49	9.49
CHAMBERS OF SHAOLIN	14.99	12.49	HITCHHIKERS GUIDE	9.99	9.99
CHAMPIONSHIP BASEBALL	9.99	6.49	HONDA RVF 750	15.49	15.49
CHAMPIONSHIP BASKETBALL	5.99	9.99	HOSTAGES	8.49	8.49
CHAMP FOOTBALL (USA)	4.99	4.99	HOUD OF SHADOW	16.99	17.49
CHAOS STRIKES BACK	12.49	12.49	HYBRIS	8.49	8.49
			INDIANA JONES (ACTION)	11.99	11.99
			INDIANA JONES (ADV)	16.99	14.99
			INFESTATION	14.99	14.99
			INTERPHASE	15.99	15.99
			IRON LORD	16.49	16.49
			JACK NICKLAU'S GOLF	15.99	17.49
			JINXTER (MAG SCROLLS)	13.99	13.99
			JOURNEY (INFOCOM)	19.49	19.99
			JUG	11.99	11.99
			KICK OFF	11.99	11.99
			KICK OFF EXPANSION DISK	7.49	7.49
			KILLING GAME SHOW	12.49	12.49
			KIND WORDS 2.0 (W/P)	33.49	33.49
			KING OF CHICAGO	8.49	7.49
			KINGS QUEST 1, 2 & 3	21.49	22.49
			KINGS QUEST 4 (SIERRA)	21.49	12.99
			KNIGHT ORC (LEVEL 9)	6.49	7.99
			KNIGHTFORCE	14.99	14.99
			KRISTAL	9.99	17.49
			KULT	8.49	8.49
			LEATHERNECKS (INFOCOM)	9.99	9.99
			LEATHERNECKS	6.49	6.49
			LEGEND OF THE SWORD	5.99	13.49
			LEISURE SUIT LARRY 2	18.99	18.99
			LEONARDO	11.99	11.99
			LIGHT FORCE (COMP)	15.99	15.99
			LIVERPOOL	11.99	11.99
			LOMBARD RAC RALLY	14.99	14.99
			LORDS OF THE RISING SUN	18.49	18.49
			MENACE	6.99	6.99
			MICROPROSE SOCCER	15.99	15.99

**SONY 3.5" 79p**  
DS/DD DISK

CHASE H.O	15.99	12.99
CHESSMASTER 2000	16.49	16.49
CHRONO QUEST	9.49	9.49
COLLOSUS CHESS X	15.49	15.49
CONFLICT EUROPE	16.49	16.49
CONTINENTAL CIRCUS	12.99	12.99
CORRUPTION (M/SCROLLS)	13.99	13.99
DAMOCLES	15.49	15.49
DEFENDER OF THE CROWN	8.49	8.49
DEJA VU	12.49	5.99
DEJA VU 2	15.99	15.99
DELUXE PAINT III	51.49	51.49
DEMONS TOMB	12.99	12.99
DRAGON SPIRIT	12.99	12.99
DRAGON'S LAIR (1 MEG)	28.49	28.49
DRAGONS OF FLAME (SSI)	17.49	17.49
DRAXKHEN	16.99	16.99
DUNGEON MASTER	15.49	15.49
DUNGEON MASTER EDITOR	7.49	7.49
DYNAMITE DUX	15.99	13.49
ELIMINATOR	5.99	5.99
ELITE	13.49	15.49
EMPEROR OF THE MINES	15.49	15.49
EYE OF HORIUS	15.99	15.99

## Myth Quotes

"An excellent adventure... witty, cunning and just plain good fun! If you liked Fish! you'll probably like this, because they're very similar in style: you may even prefer Myth, it's that good!"

Amiga Format

"Myth is destined to become a classic."

Crash Magazine **SMASH 91%**

## Myth Reviews

Commodore User 90%, Amiga Format 87%, TGM 85%

## AMIGA ST IBM

MILLENNIUM 2.2	15.99	15.99
MR HELI	15.99	15.99
NEBULUS	5.99	5.99
NEUROMANCER	16.99	16.99
NEVER MIND	12.49	12.49
NIGEL MANSELL'S G/PRIX	4.99	4.99
OPERATION WOLF	15.99	12.99
PACMANIA	7.49	11.99
PAPERBOY	7.99	5.99
PAWNA (MAG SCROLLS)	13.99	13.99
PERSONAL NIGHTMARE	18.99	18.99
PHOTON PAINT	10.99	10.99
PLAYER MANAGER	12.99	12.99
POLICE QUEST 1 (SIERRA)	15.99	15.99
POLICE QUEST 2 (SIERRA)	16.49	19.99
POPULOUS	16.49	16.49
POPULOUS PROMISED LANDS	7.99	7.99
POWER DRIFT	15.99	13.49
POWERDROME	16.49	16.49
PRECIOUS METAL	15.49	15.49
PREDATOR	15.99	15.99
PROTEXT W/PROCESSOR	64.99	47.99
PUBLISHERS CHOICE 1 MEG	66.49	66.49
PURPLE SATURN DAY	7.49	8.49
QUARTERBACK	12.99	12.99
R-TYPE	11.49	6.99
RALLY CROSS CHALLENGE	12.99	12.99
REAL GHOSTBUSTERS	8.49	7.49
RED LIGHTNING (SSI)	19.99	19.99
RED STORM RISING	16.49	11.99
RICK DANGEROUS	15.49	15.49
ROBOCOP	15.49	12.99
ROCKET RANGER	9.99	15.49
SCAPEGOAT (LEVEL 9)	12.49	12.49
SCRABBLE DE LUXE	12.99	16.49
SHADOW OF THE BEAST	19.99	19.99
SHADOWGATE	11.49	7.49
SHINOBI	12.99	12.99
SHOGUN (INFOCOM)	9.99	19.99
SHOOT 'EM-UP CONSTR KIT	18.49	18.49
SILKWORM	12.99	12.99
SIM CITY	17.49	18.49

## AMIGA ST IBM

SPACE ACE	27.49	27.49
SPACE QUEST 3 (SIERRA)	19.49	11.49
SPEEDBALL	15.49	15.49
SPHERICAL	12.99	12.99
STAR WARS TRILOGY	15.99	15.99
STARGLIDER	6.49	6.49
STARGLIDER 2	13.99	15.49
STATIONFALL (INFOCOM)	9.99	9.99
STEVE DAVIS SNOOKER	12.49	12.49
STORMLORD	15.49	15.49
STRIDER	13.49	13.49
STRIKE FORCE HARRIER	5.49	5.49
STRYX	12.49	12.49
STUNT CAR RACER	15.99	15.99
SUPER HANG ON	8.49	8.49
SUPER WONDERBOY	15.99	12.99
SWORD OF SODAN	13.99	13.99
TEENAGE QUEEN	8.49	8.49
TESTDRIVE	8.49	9.99
TETRIS	4.49	6.49
THE NEW ZEALAND STORY	15.99	12.99
THE STORY SO FAR VOL 3	12.99	12.99
THREE STOOGES	6.99	7.49
THUNDERBIRDS	8.49	8.49
TIME BANDIT	6.49	6.49
TIMES OF LORE	16.49	9.99
TRIAD VOL 1 (COMPILATION)	9.49	9.49
TRIAD VOL 2 (COMPILATION)	14.99	14.99
TV SPORTS FOOTBALL (USA)	13.49	15.49
ULTIMA IV	16.49	17.49
UNINVITED	12.49	5.99
UNTOUCHABLES	15.99	12.99
VETTE (CORVETTE)	18.49	18.99
VIRUS	12.49	6.99
VIXEN	4.49	4.49
WAR IN MIDDLE EARTH	15.49	15.49
WATERLOO	15.99	15.99
WAYNE GRETZKY HOCKEY	15.99	15.99
WHO FR ROGER RABBIT	9.49	9.99
XENOMORPH	15.49	15.49
XENON II MEGABLAST	15.49	15.49
XENOPHOBE	15.99	15.99
ZORK ZERO (INFOCOM)	19.49	19.99

To order please write, or complete the coupon, or telephone us on **0279 600204**. Please note that there is a surcharge of 50p per game for orders placed by telephone.

## Order Form

Name \_\_\_\_\_  
Address \_\_\_\_\_

Post Code \_\_\_\_\_ Phone No. \_\_\_\_\_  
Computer \_\_\_\_\_ \*5.25"/\*3.5"/\*3.0"/TAPE

Payable to: **Special Reserve or Official Secrets**  
P.O. Box 847, Harlow, CM21 9PH

Special Reserve and Official Secrets are trading names of Inter-Mediate Ltd.  
Reg. Office: 2 South Block, The Maltings, Sawbridgeworth, Herts CM21 9PG.  
Registered in England Number 2054713. VAT reg. no. 424 8532 51

Special Reserve membership £5 UK, £6 EEC or £7 World

or

Official Secrets membership £22 UK, £25 EEC or £30 World

with Gnome Ranger and Myth  or with Surprise Alternative and Myth

Item \_\_\_\_\_ ACE \_\_\_\_\_

Item \_\_\_\_\_

TOTAL \_\_\_\_\_

Credit card expiry date \_\_\_\_\_

\*CHEQUE/\*POSTAL ORDER/\*ACCESS/\*VISA  
(Including Connect, Mastercard and Eurocard)  
\*Delete where applicable

Overseas orders must be paid by credit card  
Prices include UK Postage and Packing  
EEC orders please add 70p per item  
World orders please add £1.50 per item







# WIN A HAND-HELD GAME BOY OR DELUXE NES CONSOLE, COURTESY OF NINTENDO

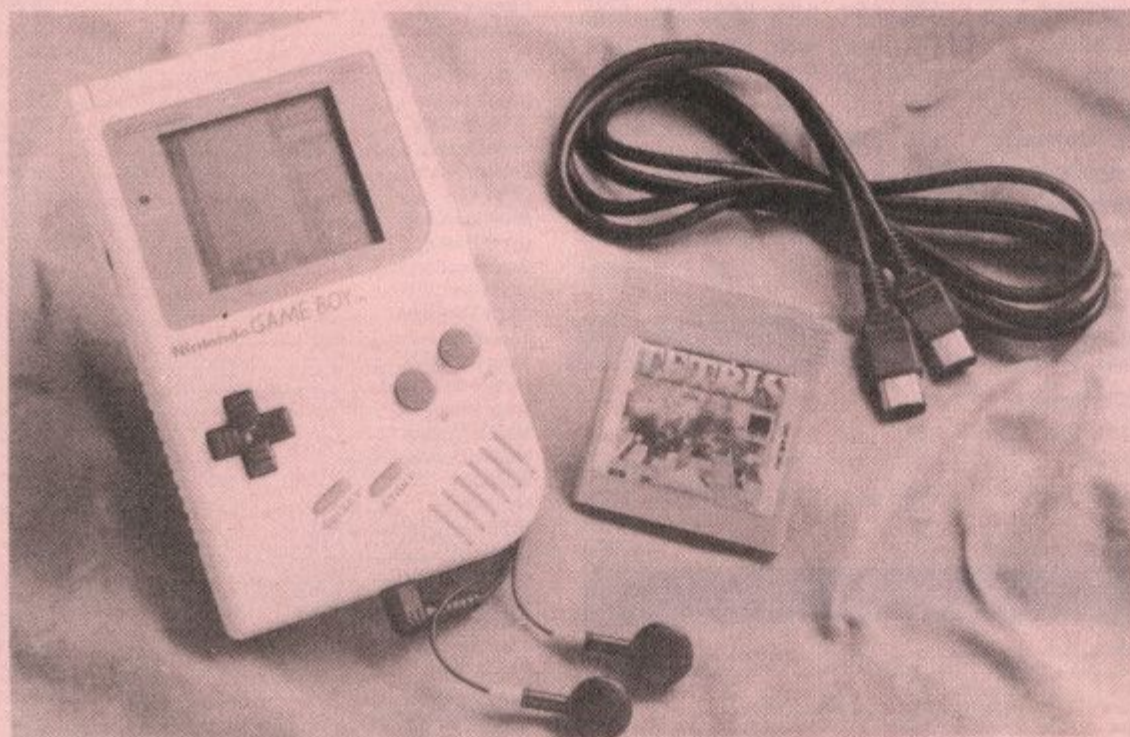

## TEN NINTENDO FACTS

- 1 Nintendo of America has approximately 90% share of the US home video game market.
- 2 A US team of more than 80 game counselors are on hand to answer 50000 calls per week from Nintendo gamers seeking game tips and strategies.
- 3 9.1 million *Super Mario Bros.* game cartridges have been sold in the US since 1987, 3 million *The Legend of Zelda* game cartridges have been sold in the US since 1987, and 3.5 million *Super Mario Bros. II* game cartridges have been sold in the US since autumn 1988.
- 4 Nintendo celebrated its 100th anniversary in 1989.
- 5 Japanese consumers have purchased nearly 14 million Nintendo hardware units and 145 million software units, earning Nintendo more than 90% market share and greater than 35% penetration of Japanese households.
- 6 Nintendo was the first video game manufacturer to offer software with a programmability function and lithium-powered memory.
- 7 25% of all US females between the ages of 12 and 17 play Nintendo games.
- 8 *Nintendo Power*, a bimonthly paid-subscription magazine, has more than 1.2 million subscribers.
- 9 Hungry US Nintendo fans can tuck into two different fruit-flavoured cereal combinations shaped like favourite Nintendo game characters.
- 10 Every Saturday morning, American kids can tune into a half-hour Nintendo cartoon featuring their favourite Nintendo game characters.

Launched at CES in Chicago last June, the Nintendo Game Boy is a fully portable video game system which uses interchangeable cartridges and offers multi-player action, monochrome LCD display and digital stereo sound. The Game Boy will be officially launched in the UK at the Earl's Court Toy Fair in January.

With each Game Boy you get the superlative Soviet-sourced *Tetris* game, stereo earphones and Video Link – an accessory that allows two or more players to connect their Game Boys and compete tournament-style among themselves.

In addition to *Tetris*, there is a large, and ever increasing, library of Game Boy titles including *Super Mario Land*, *Loderunner* and *Tennis*.

Although a UK price is yet to be set, the average Game Boy US retail price is \$89.95, with \$19.95 per game cartridge.

The Nintendo NES is the most popular video game system in the world, the Deluxe NES includes control deck, two hand-held controllers, ROB (Robot Operated Buddy), Zapper light gun and two game cartridges (*Duck Hunt* and *Super Mario Bros*). As well as a huge range of games titles like *The Legend of Zelda*, *Super Mario Bros II* and *III*, and *Gradius*, Japanese Nintendo researchers have developed an exciting range of peripherals which include Powerpad (an interactive electronic mat which allows the player's body movements to control the on-screen action of the characters), Hands Free (a controller which helps the physically disabled enjoy home video game play with the help of a "sip and puff tube"), and a computerised knitting machine.

## GO FOR IT

Winning a Nintendo Game Boy or Deluxe NES couldn't be simpler, just answer the following questions:

1. When was Nintendo founded?  
(a) 1889 (b) 1967 (c) 1987
2. Which computer, console or coin-op game would you most like to see converted to the Nintendo Game Boy? Why?
3. Finally, tell us which are your TWO favourite articles or sections in this month's ACE, and your TWO least favourite sections. Don't worry – there are no "right answers" for this question. We just want to hear your views, and whatever you say will in no way affect the outcome of the competition.

Please write your answers (in BLOCK CAPITALS) on the back of a postcard. Don't forget to include your full name, address and telephone number.

Send your completed postcard to:

**ACE NINTENDO COMPETITION,  
Priory Court, 30-32 Farringdon Lane,  
London EC1R 3AU.**

## THE PRIZES

The Nintendo Game Boy will be awarded to the first entry – drawn at random from the entries received prior to the closing date – giving the correct answer to question (1). The Nintendo Deluxe NES will be awarded to the second correct entry.

### THE RULES

- (1) The closing date for entries is 7th January, 1990.
- (2) Employees of EMAP and Nintendo are not eligible for entry.
- (3) The editors decision is final and no correspondence will be entered into.



# PREMIER MAIL ORDER

GAME	SPEC		CBM		AMS	
	CASS	DISC	CASS	DISC	CASS	DISC
Afterburner	6.99	10.99	6.99	10.99	6.99	10.99
Am.Civil War Vol.2				14.99		
Airbourne Ranger	6.99	9.99	9.99	13.99	9.99	13.99
APB	6.99	9.99	6.99	9.99	6.99	9.99
Artic Fox	2.99		2.99		2.99	
Bards Tale 2 or 3				12.99		
Batman Caped Crusader	5.99	9.99	6.25	9.99	6.25	9.99
Battlefront				14.99		
Blood Valley	2.99				2.99	
Carrier Command	9.99	13.99	9.99	13.99	9.99	13.99
Carriers at War				14.99		
Chuck Yeager			7.50	10.99	7.50	10.99
Classic Collections			2.99		2.99	
Crazy Cars 2	6.50				6.50	9.99
Cricket Master	6.50		6.50		6.50	
Curse of Azure Bands				16.99		
Dragon Ninja	6.50	9.99	6.99	9.99	6.99	9.99
Earth Orbit Station				5.99		
Emlyn Hughes FBall	6.99	9.99	6.99	9.99	6.99	9.99
Foot Man 2 Exp Kit	5.50		5.50	7.99	5.50	7.99
Football Director	6.50		6.45		6.45	
Football Manager 1	2.99		2.99		2.99	
Football Manager 2	6.99	9.99	6.99		6.99	9.99
Forgotten World	6.99		7.50		7.45	
Fun School 2 (6-8)	7.99	9.99	7.99	9.99	7.99	9.99
Fun School2 (Over 8)	7.99	9.99	7.99	9.99	7.99	9.99
Fun School 2 (Under 6)	7.99	9.99	7.99	9.99	7.99	9.99
Game Over	2.99		2.99		2.99	
Game.Set & Match 2	8.99		8.99		8.99	
Garfield Winter	6.00		6.50	9.99	6.50	9.99
Grand Prix Circuit			7.45	10.99		
Gunship	6.99	9.99	9.99	13.99	9.99	13.99
Heroes of the Lance	6.99	10.99	7.45	10.99	7.45	10.99
Hillstar				13.99		
Hostages			6.50	9.99		
Indy Jones Crusade	6.99		8.99	10.99	7.50	10.99
Last Ninja			6.99	9.99		
Last Ninja 2	6.99		6.99	9.99	6.99	10.99
Legacy of ancients				5.99		
License to Kill	6.99	9.99	6.99	9.99	6.99	9.99
Marble Madness				5.99		
Micro Soccer	6.99	9.99	9.99	13.99	9.99	13.99
Mini Office 2			10.99	13.99	9.99	13.99
Mr Hell	6.99		6.99		6.99	
Myth	7.99		7.99		7.99	
New Zealand Story	6.50	9.99	6.99	9.99	6.99	9.99
Operation Wolf	6.50	9.99	6.99	9.99	6.99	9.99
Passing Shot	6.99		6.99		6.99	
Pirates			8.99	13.99		13.99
R Type	6.99		6.99	10.99	6.99	10.99
Rambo 3	5.99	9.99	6.50	9.99	6.45	9.99
Red Heat	5.99		7.50		6.50	
Red Storm Rising			9.99	12.99		
Rick Dangerous	6.99	9.99	6.99	9.99	6.99	9.99
Robocop	5.99	9.99	6.50	9.99	6.50	9.99
Rock Star	5.99					
Rocket Ranger				12.99		
Run the Gauntlet	5.99		6.50	9.99	6.50	9.99
Russia				13.99		
Shinobi	6.99	9.99	6.99	9.99	6.99	9.99
Shoot em up con Kit			10.99	14.99		
Shoot Out	3.99	6.99	3.99		7.45	10.99
Silent Service	6.99		6.99	9.99	6.99	9.99
Skate or Die	6.99	10.50	7.50	10.99	7.45	10.99
Skyfox 2				5.99		
Speedball			7.99	9.99		
Star Wars Trilogy	8.99	10.99	8.99	10.99	8.99	10.99
Strider	6.99		7.50	9.99	7.50	9.99
Strip Poker 2 +	6.50		6.99	9.99		
Supreme Challenge	8.99	11.99	8.99	11.99	8.99	11.99
Taito Coin Op	8.50		8.99		8.99	
Techno Cop	6.50	10.99	7.50	10.99	7.45	10.99
The In Crowd	8.99		8.99		8.99	
The National	6.99			6.99		
Thunder Birds	8.99	9.99	8.99	9.99	8.99	9.99
Titan	6.50		6.50		6.50	
Tokien Trilogy	8.99		8.99	13.99	8.99	13.99
Tracksuit Manager	6.50		6.99		6.99	
Tusker	7.99		7.99		7.99	
Twin Turbo V8	2.99				2.99	
Ultimate Golf			9.99	14.99		
Vigilante	6.99		7.50		7.50	
Vinicators (Domark)	6.50	9.99	6.50	9.99	6.50	9.99
War in Middle Earth	6.99	9.99	6.99	9.99	6.99	9.99
WEC Le Mans	5.99	9.99	6.50	9.99	6.25	9.99
World Tour Golf			2.99			
Xenophobe	6.99	9.99	6.99	9.99	6.99	9.99
Xybots	6.99	9.99	6.99	9.99	6.99	9.99
Zak McKracken				10.99		

## 8 Bit New Titles

GAME	SPEC		CBM		AMS	
	CASS	DISC	CASS	DISC	CASS	DISC
* Operation Thunderbolt	6.99	9.99	6.99	9.99	6.99	9.99
* Chase HQ	6.99	9.99	6.99	9.99	6.99	9.99
Cabel	6.50	9.99	6.99	9.99	6.99	9.99
* Beach Volley	6.50	9.99	6.99	9.99	6.99	9.99
Batman the Movie	6.99	9.99	6.99	9.99	6.99	9.99
Untouchables	6.50	9.99	6.99	9.99	6.99	9.99
Fighting Soccer	6.99	—	6.99	9.99	6.99	9.99
Altered Beast	6.99	—	6.99	9.99	6.99	9.99
Dynamite Dux	6.99	—	6.99	9.99	6.99	9.99
Super Wonderboy	6.99	—	6.99	9.99	6.99	9.99
Powerdrift	6.99	—	6.99	9.99	6.99	9.99
Dragon Spirit	6.99	9.99	6.99	9.99	6.99	9.99
* Hard Drivin'	6.99	9.99	6.99	9.99	6.99	9.99
* Cyberball	6.99	9.99	6.99	9.99	6.99	9.99
* Toobin	6.99	9.99	6.99	9.99	6.99	9.99
Strider	6.99	—	7.50	9.99	7.50	9.99
* Rainbow Islands	6.99	9.99	6.99	9.99	6.99	9.99
Ghostbusters 2	6.99	—	6.99	9.99	6.99	9.99
Continental Circus	6.99	9.99	6.99	9.99	6.99	9.99
* Double Dragon 2	6.99	9.99	6.99	9.99	6.99	9.99
* Ninja Warriors	6.99	9.99	6.99	9.99	6.99	9.99
Battlechess	—	—	—	10.99	—	—
Laser Squad	6.99	9.99	6.99	9.99	6.99	9.99
Stunt Car Racer	6.99	9.99	6.99	9.99	—	—
100% Dynamite	9.99	—	9.99	12.99	9.99	—
* Dark Force	9.99	—	9.99	12.99	9.99	—
Kick Off	6.99	—	6.99	9.99	—	—
* Golden Shoe	6.99	9.99	6.99	9.99	6.99	9.99

### GAME SPEC CBM AMS

## 8 Bit Special Offers

GAME	SPEC		CBM		AMS	
	CASS	DISC	CASS	DISC	CASS	DISC
Ace 2088	3.99	—	3.99	—	3.99	—
Ankh	—	—	1.00	—	—	—
Cobra	2.99	—	2.99	—	2.99	—
Crazy Cars	2.99	—	2.99	—	2.99	—
Comet Game	1.00	—	1.00	—	1.00	—
Doomdarks Revenge	2.99	—	—	—	—	—
Enigma Force	2.99	—	—	—	—	—
Enduro Racer	2.99	—	2.99	—	2.99	—
Batman	2.99	—	—	—	2.99	—
Gauntlet 1 or 2	2.99	—	2.99	—	2.99	—
Green Beret	2.99	—	2.99	—	2.99	—
Gyron	1.00	—	—	—	—	—
Inc Shrink Sphere	3.99	—	3.99	—	6.99	—
Konami Tennis	2.99	—	—	—	—	—
Match Point	—	—	2.99	—	—	—
Rampage	2.99	—	2.99	—	2.99	—
Ramb	2.99	—	2.99	—	6.99	—
Road Runner	2.99	—	2.99	—	2.99	—
720	2.99	—	2.99	—	2.99	—
Bombuzal	—	—	3.99	—	—	—
Short Circuit	2.99	—	2.99	—	2.99	—
Soldier of Light	2.99	—	2.99	—	6.99	—
Summer Games	2.99	—	2.99	—	2.99	—
Super Cycle	2.99	—	2.99	—	2.99	—
Wizball	2.99	—	2.99	—	2.99	—
W.S. Baseball	2.99	—	2.99	—	2.99	—
Ye Ar Kung Fu	2.99	—	2.99	—	2.99	—
Serve and Volley	—	—	2.99	—	5.99	—
Rack Em	—	—	2.99	—	5.99	—
Fase Break	—	—	2.99	—	5.99	—
PHM Pegasus	2.99	—	2.99	—	5.99	—
Commando	2.99	—	2.99	—	2.99	—
Paperboy	2.99	—	2.99	—	2.99	—
Spy Hunter	2.99	—	2.99	—	2.99	—
Barbarian (pal)	2.99	—	2.99	—	2.99	—
Bards Tale	2.99	—	2.99	—	5.99	—
Arc of Yesod	2.00	—	—	—	—	—
Nodes of Yesod	2.00	—	—	—	—	—
Star Wars	3.99	—	3.99	—	3.99	—
Empire Strikes Back	3.99	—	3.99	—	3.99	—
Return of Jedi	3.99	—	3.99	—	3.99	—
World Games	2.99	—	2.99	—	2.99	—
Phobia	—	—	3.99	—	—	—
Ace of Aces	2.99	—	2.99	—	2.99	—
Top Gun	2.99	—	2.99	—	2.99	—
Hypersports	2.99	—	2.99	—	2.99	—
Plstop 2	2.99	—	2.99	—	2.99	—
Jack the Nipper	2.99	—	2.99	—	2.99	—
Monty on the Run	2.99	—	2.99	—	2.99	—
Crystal Castles	2.99	—	2.99	—	2.99	—
Turbo Esprit	2.99	—	2.99	—	2.99	—
Street Fighter	2.99	—	2.99	—	2.99	—
Bionic Commando	2.99	—	2.99	—	2.99	—

## SEGA SOFTWARE

GAME	PRICE
Action Fighter	22.95
Afterburner	24.95
Alex Kid in Miracle World	22.95
Alex Kid Lost Stars	24.95
Alien Syndrome	24.95
Alteréd Beast	24.95
American Baseball	24.95
Astro Warrior	22.95
Aztec Adventure	22.95
Bank Panic	14.95
Black Belt	22.95
Blade Eagle 3D	24.95
Bomber Raid	24.95
California Games	27.95
Captain Sliver	24.95
Choplifter	22.95
Cyborg Hunter	24.95
Double Dragon	24.95
Enduro Racer	22.95
F16	14.95
Fantasy Zone	22.95
Fantasy Zone 2	24.95
Fantasy Zone 3	24.95
* Galaxy Force 2	27.95
Ganster Town	19.95
Ghostbusters	27.95
Ghost House	14.95
Global Defence	22.95
Golvelious	24.95
Great Baseball	22.95
Great Basketball	22.95
Great Football	22.95
Great Golf	22.95
Great Volleyball	22.95
Kenseiden	24.95
Kung Fu Kid	22.95
Lord of the Sword	24.95
Maze Hunter 3D	24.95
Miracle Warrior	32.95
Missile Defence 3D	24.95
Monopoly	29.95
My Hero	14.95
Ninja	22.95
Outrun 3D	24.95
Outrun	24.95
Penguin Land	29.95
Phantasy Star	39.95
Poseidon Wars 3D	24.95
Power Strike	22.95
* Pro Football	24.95
Pro Wrestling	19.95
Quartet	19.95
R Type	29.95
Rambo 3	24.95
Rampage	24.95
Rastan	24.95
Rescue Mission	22.95
Rocky	24.95
Secret Command	24.95
Shanghai	22.95
Shinobi	24.95
Shooting Gallery	22.95
Shooting Games	22.95
Space Harrier	24.95
Space Harrier 3D	24.95
Spy v Spy	14.95
Super Tennis	14.95
Teddy Boy	14.95
Thunderblade	24.95
Time Soldiers	24.95
Transbot	14.95
Vigilante	24.95
Wonderboy	22.95
Wonderboy 3	27.95
Wonderboy Monsterland	24.95
World Grand Prix	22.95
World Soccer	22.95



PC OWNERS PLEASE STATE 51/4" OR 31/2" DISC. TITLES MARKED \* ARE NOT YET AVAILABLE AND WILL BE SENT ON DAY OF RELEASE. PLEASE SEND CHEQUE/PO/ACCES/VISA No. AND EXPIRY DATE TO: DEPT AC01, TRYBRIDGE LTD, 8 BUCKWINS SQ, BURNT MILLS, BASILDON, ESSEX. SS13 1BJ. PLEASE STATE MAKE AND MODEL OF COMPUTER WHEN ORDERING. P & P INC. UK ON ORDERS OVER £5.00. LESS THAN £5.00 AND EUROPE ADD £1.00 PER ITEM. ELSEWHERE PLEASE ADD £2.00 PER ITEM FOR AIRMAIL. THESE OFFERS ARE AVAILABLE MAIL ORDER ONLY. TEL ORDERS: 0268-590766

PRICE

GAME	ST	AMIGA	PC
3D Pool	11.99	11.99	—
6-88 Attack Sub	—	—	19.95
A-Max	—	134.95	—
A-Max with ROM	—	249.95	—
Abrahams Battle Tank	—	—	19.95
Atherburner	13.99	16.99	—
Arbourne Ranger	14.99	14.99	—
Alien Legion	16.99	16.99	—
Alien Syndrome	7.99	7.99	—
APB	12.99	12.99	—
Archepegos	16.99	16.99	19.99
Armageddon Man	7.99	7.99	—
Action Fighter	16.99	15.99	—
Ball	11.99	14.99	—
Balance of Power	16.99	16.99	15.00
Balistic	11.99	11.99	—
Bar Games	—	—	16.99
Barbarian 2 pal	14.99	14.99	—
Barbarian pal	11.99	11.99	—
Bards Tale 2	—	17.99	19.95
Batman Caped Crusader	11.99	16.99	—
Battlechess	16.99	16.99	17.95
Battlehawks 1942	16.99	16.99	17.00
Bermuda Project	7.99	7.99	—
Blackjack Academy	—	7.99	—
Blasteroids	9.99	9.99	—
Blood Money	16.99	16.99	—
Bloodwych	16.99	16.99	—
Bombuzal	9.99	9.99	—
Borrowed Time	—	—	7.95
California Games	16.99	16.99	—
Capona	17.99	19.99	19.99
Carrier Command	14.99	14.99	14.99
Challenger	—	3.99	—
Chronoquest	18.99	18.99	19.95
Chuck Yeager AFT	—	—	19.95
Colossus Chess X	15.99	15.99	—
Conquon	14.99	14.99	14.95
Cosmic Pirate	11.99	14.99	—
Crazy Cars 2	11.99	11.99	14.90
Cyberoid 2	11.99	11.99	—
Dark Castle	7.99	7.99	9.99
Day of the Viper	15.99	15.99	—
Defektor	9.99	—	—
Degas Elite	17.99	—	—
Deluxe Music Con Set	—	49.99	—
Deluxe Paint 3 (1 meg)	—	49.99	69.99
Deluxe Photolab	—	49.99	—
Deluxe Print 2	—	49.99	—
Deluxe Production	—	89.99	—
Deluxe Video	—	49.99	—
Don't go Alone	—	—	16.99
Double Dragon	11.99	11.99	15.99
Dragon Ninja	12.99	15.99	—
Dragonlar (1 meg)	—	29.99	—
Dragon Master	15.99	15.99	—
Eliminator	13.99	13.99	—
Elite	14.99	14.99	—
Emanuelle	11.99	11.99	11.05
Empire	8.99	8.99	16.95
F15Strike Eagle 2	—	—	26.99
F16 Combat Pilot	16.99	16.99	16.95
F19 Stealth Fighter	—	—	26.99
Fahrenheit 451	7.99	—	—
Falcon F16	16.99	19.99	24.95
Falcon Mission Disk 1	13.99	13.99	—
Fantavision	—	29.99	—
Fed Free Trade	19.99	19.99	—
Fernandez Must Die	7.99	7.99	—
Ferrari Formula 1	16.99	16.99	19.95
Finpower	—	—	12.99
Frezzone	—	7.99	—
Fish	14.99	14.99	14.99
Fleet St Editor	110.00	—	—
Flight Sim 2	26.99	26.99	32.95
Fit Disc 7 or 11	13.99	13.99	—
Fit Disc European	13.99	13.99	19.99
Fit Disc Japan	13.99	13.99	19.99
Fit Disc 1 to 7	—	—	11.95
Flying Shark	14.99	14.99	—
Foot Man 2 Exp Kit	8.99	8.99	8.99
Football Director 2	11.99	11.99	11.95
Football Manager 2	11.99	11.99	11.95
Fortress Underground	—	3.99	—
Fun School 2 (6-8)	15.99	15.99	15.99
Fun School 2 (Over 8)	15.99	15.99	15.99
Fun School 2 (under 6)	15.99	15.99	15.99
Gaisto Invasion	—	7.99	—
Gadregona Domain	12.99	12.99	—
Garfield	9.99	9.99	—
Garfield Winter	12.99	12.99	—
Golden Path	7.99	7.99	—
Goldrunner	7.99	7.99	—
Grand Prix Circuit	—	16.99	—
Gunship	14.99	14.99	25.95
Ghostbusters 2	13.99	16.99	—
Hacker 2	7.99	7.99	—
Hawkeye	12.99	12.99	—
Hellfire Attack	9.99	9.99	—
Helter Skelter	9.99	9.99	—
Herpes of the Lance	16.99	15.99	16.95
Hitchhiker's Guide	—	—	9.99
Hostages	14.99	14.99	14.99
Hunt for Red October	14.99	14.99	—
Hybris	—	19.99	—
Indy Jones Action	13.99	13.99	13.99
Indy Jones Adventure	16.99	16.99	16.99
Insanity Flight	—	7.99	—
Interceptor	—	15.99	—
Int Karate	13.99	16.99	—
Iron Lord	16.99	16.99	—
Jack Nicklaus Golf	16.99	16.99	—
Jel	26.99	26.99	26.95
Joan of Arc	13.99	15.99	13.95
John Madden Football	—	—	16.99
Karting Grand Prix	7.99	—	—
Keep the Thief	—	16.99	—
Kennedy Approach	14.99	14.99	—
Kick Off	11.99	11.99	—
Kind Words 2	—	34.99	—
King of Chicago	16.99	—	9.99
Kings Quest 4	21.99	21.99	—
Kristal	17.99	17.99	19.95
Kull	14.99	14.99	14.99
Leaderboard Bddie	13.99	13.99	—
Lancelot	11.99	12.99	11.95
Legend of DeJ	16.99	16.99	—
Leisure Suit Larry 1 or 2	19.99	19.99	19.99
Leisure Suit Larry 1 or 2 Hints	6.99	6.99	6.99
License to Kill	12.99	12.99	12.99
Life and Death	16.99	16.99	16.99
Lombard RAC Rally	14.99	14.99	16.99
Lords of the Rising Sun	—	19.99	—
Manhattan Dealer	11.99	14.99	14.95
* Light Force	16.99	16.99	—

## 16 Bit New Titles

GAME	ST	AMIGA	PC
Altered Beast	13.99	16.99	—
Fighting Soccer	13.99	16.99	—
Dynamite Dux	13.99	16.99	—
Powerdrift	16.99	16.99	—
Ghostbusters 2	13.99	16.99	—
Super Wonderboy	13.99	16.99	—
* Cabal	13.99	16.99	—
* Chase HQ	13.99	16.99	—
* F29 Retaliator	13.99	16.99	—
* Lost Patrol	13.99	16.99	—
* Operation Thunderbolt	13.99	16.99	—
* Untouchables	13.99	16.99	—
Continental Circus	13.99	13.99	—
Double Dragon 2	13.99	13.99	—
* Ninja Warriors	13.99	13.99	—
* Mid Winter	15.99	15.99	15.99
Strider	13.99	16.99	—
* Amos	—	19.99	—
Beach Volley	13.99	16.99	—
Batman the Movie	13.99	16.99	—
* Toobin	13.99	13.99	—
* Hard Drivin	13.99	13.99	—
Laser Squad	12.99	12.99	—
* Golden Shoe	13.99	16.99	—
Pro Tennis Tour	16.99	16.99	—
* Player Manager	12.99	12.99	—
* Vette	—	—	19.99
* It Came From The Desert (1 meg)	—	19.99	—
* Chaos Strikes Back	16.99	—	—

## 16 Bit Special Offers

Game	ST	AMIGA	PC
Alien Strike	—	3.99	—
Barbarian (pal)	7.99	7.99	—
Bionic Commando	7.99	7.99	—
Empire	8.99	8.99	—
Starfleet	8.99	8.99	—
Fusion	7.99	7.99	—
Bullyhoo	7.99	—	—
Captain Blood	7.99	7.99	—
Craps Academy	—	7.99	—
Crazy Cars	—	7.99	—
De Ja Vu	7.99	7.99	—
Empire Strikes Back	7.99	7.99	—
Star Wars	7.99	7.99	—
Return of Jedi	7.99	7.99	—
Fast Break	—	—	7.99
Brack em	—	—	7.99
Serve and Volley	—	—	7.99
Foundations Waste	7.99	7.99	—
Hollywood Hijinx	7.99	—	—
Jump Jet	—	3.99	—
Las Vegas	7.99	—	—
Manix	—	7.99	—
Marja Whittaker	7.99	—	7.99
Nord and Bert	—	7.99	9.99
Orbiter	7.99	—	—
Perry Mason	7.99	—	—
Pacland	9.99	9.99	—
Pacmania	9.99	9.99	—
Romantic Encounters	—	7.99	—
SDI (Activision)	7.99	—	—
Sea Stalker	—	7.99	—
Shadowgate	9.99	9.99	—
Skychase	7.99	7.99	—
Soldier of Light	7.99	7.99	—
Speedball	10.99	10.99	19.99
Sundog	7.99	—	—
TKO	—	—	7.99
Tetris	7.99	7.99	—
Trivia Trove	3.99	3.99	—
Vixen	7.99	7.99	—
Nigel Mansell	7.99	7.99	—
Zork 1 or 2	7.99	—	—
City Defence	—	3.99	—
Garfield	9.99	9.99	—
Leather Goddess	—	—	9.99
Seconds Out	—	7.99	—
Wishbringer	7.99	—	—
Inc Shrink Sphere	7.99	7.99	—

Masters of the Universe	9.99	—	—
Mayday Squad	11.99	12.99	—
Menace	11.99	12.99	—
Micropose Soccer	14.99	14.99	15.99
Mike the Dragon	—	3.99	—
Millemum 2 2	16.99	16.99	16.99
Mindfighter	—	7.99	—
Mindshadow	7.99	—	—
Mini Office Comms	16.99	—	—
Mini Office Personal	—	—	22.95
Mini Office Spread	16.99	—	—
Moonmist	7.99	—	—
Mr Hell	15.99	15.99	—
Magic Mansion	16.99	16.99	—
M1 Tank Platoon	—	—	26.99
Netherworld	13.99	17.99	—
Neuroancer	—	—	19.95
New Zealand Story	13.99	16.99	—
Nighthunter	13.99	—	—
Northstar	9.99	—	—
Operation Wolf	11.99	14.99	11.95
Orbiter	9.99	—	—
Outrun	8.99	—	—
Paperboy	12.99	12.99	—
Peter Beardsley Soccer	12.99	7.99	—
Phalanx 2	—	3.99	—
Phantom Fighter	—	7.99	—
Phobia	9.99	9.99	—
Pioneer Plague	—	14.99	—
Pvaltes	15.99	—	—
Police Quest 1 or 2	16.99	16.99	16.99
Police Quest 1 or 2 Hints	6.99	6.99	6.99
* Pools of Radiance	16.99	16.99	16.99
Populus	16.99	16.99	16.99
Populus Promised Land	7.99	7.99	—
Powerdrome	16.99	16.99	—
Precious Metal	15.99	15.99	—
Prison	7.99	7.99	—
PT 109	—	—	14.99
Purple Saturn Day	14.99	14.99	14.95
Quintax	—	3.99	—
R Type	13.99	16.99	—
Raider	—	11.99	—
Rainbow Island	15.99	15.99	—
Rainbow Warner	15.99	15.99	—
Rambo 3	11.99	—	—
Reach for Stars	—	15.99	17.95
Red Heat	12.99	15.99	—
Red Storm Rising	—	—	25.99
Return to Genesis	11.99	11.99	—
Rick Dangerous	15.99	15.99	15.99
Road Blasters	13.99	13.99	—
Robocop	12.99	15.99	12.99
Rocket Ranger	16.99	19.99	19.99
Run the Gauntlet	11.99	15.99	—
Running Man	14.99	14.99	—
RVF Honda	14.99	14.99	—
Sentinel Worlds	—	—	17.99
Shanghai	—	—	9.99
Shoot em up Con Kit	19.99	19.99	—
Silent Service	14.99	14.99	14.99
Silkworm	12.99	12.99	—
Skulduggery	7.99	—	—
Sleeping Gods Lie	14.99	14.99	14.99
Space Harrier 2	13.99	16.99	—
Space Quest 1 or 2	—	—	16.99
Space Quest 3	19.99	26.99	26.99
Space Quest 3 Hints	6.99	6.99	6.99
Star Fleet	7.99	7.99	—
Starfleet	—	—	16.99
Starglider 2	14.99	14.99	26.99
Steel Thunder	—	—	16.99
Steve Davis Snooker	11.99	12.99	—
Stos	13.00	—	—
Stos Compiler	13.99	—	—
Stos Maestro	16.99	—	—
Stos Scrips 600	11.99	—	—
Strike Fleet 1	—	—	18.99
Strike Force Harrier	7.99	7.99	—
Strip Poker 2	9.99	9.99	—
Sturican Racer	15.99	15.99	—
Super Hangon	13.99	16.99	—
Sword of Sodor	—	14.99	—
Swords of Twilight	—	16.99	—
Star Wars Trilogy	16.99	16.99	—
Shinobi	12.99	12.99	—
Shadow of Beast	—	26.99	—
Talespin	17.99	17.99	17.99
Tank Attack	14.99	14.99	—
Tass Times	7.99	—	—
TD2 Supercars	—	8.99	8.99
TD2 California Chaff	—	8.99	8.99
TD2 Muscle Cars	—	8.99	8.99
Tech	13.99	13.99	—
Testdrive 2 The Dual	—	14.9	



# SEGA® MEGA DRIVE

ONLY MENTION MEGADRIVES OFFER THE FOLLOWING:-

1. ALL ARE PAL/RGB (SCART, AMSTRAD, 10845 MONITORS ETC).
2. COMPOSITE PAL OUTPUT:- NOT INFERIOR VERSIONS WHERE THE DATA BUS CANNOT BE USED OF FUTURE GAME/PERIPHERALS.
3. COMPATIBLE WITH JAPANESE/AMERICAN/FUTURE UK 16 BIT & 8 BIT GAMES. THIS IS CURRENTLY THE ONLY MEGADRIVE COMPATIBLE WITH ALL 16 BIT SYSTEMS ON SALE IN THE UK/EUROPE.
4. WORKS IN EVERY PAL SYSTEM (WITHOUT A LEAD HANGING FROM THE BACK!!).

ONLY **£199.95** WITH FREE GAME (ALTERED BEAST, SPACE HARRIER II, SUPER THUNDER BLADE, ALEX KIDD).

ALL TITLES IN STOCK, RING FOR DETAILS.

## PC ENGINE PLUS

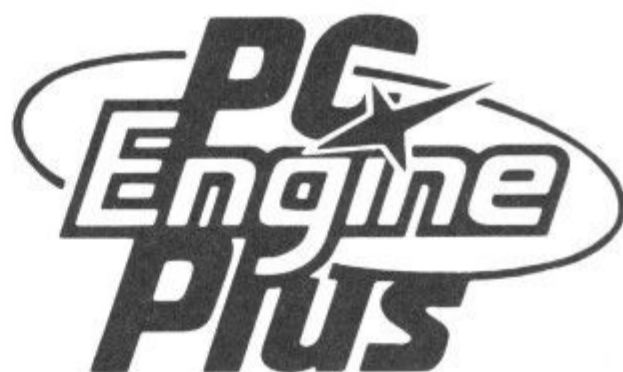

ONLY £199.95 WITH FREE GAME.

OUR PC ENGINE WORKS WITH ALL PERIPHERALS NOW (SEE NOVEMBER ISSUE OF ACE MAGAZINE FOR EXCLUSIVE REVIEW). NEW MACHINES IN STOCK, ALL SOFTWARE AND HARDWARE IN STOCK, RING FOR DETAILS. (ALL MAJOR CREDIT CARDS TAKEN).

## PERSONAL ACRCADE PLUS MACHINE

THE NEW "HOME ARCADE" IS AVAILABLE NOW. RUNS SEGA, NINTENDO, PC ENGINE, ALL HOME COMPUTERS (SEE C&VG FOR DETAILS) 100% ARCADE MACHINE - IT RUNS THE FULL RANGE OF PCBS (WITH JAMMA CONNECTORS). COMES IN FOUR COLOURS AND IS READY BUILT - NOT FLAT PACKED

## MENTION TECHNICAL SERVICES

0803 - 606146

PO BOX 18, HELENSBURGH

(SAE FOR DETAILS OF ALL MENTION PRODUCTS)



# Nintendo

NEW "DIMENSION PLUS", AMERICAN NINTENDO CARTRIDGE CONVERTORS AVAILABLE SOON. THESE RUN ALL OUR CARTRIDGES IN EVERY NINTENDO SYSTEM IN THE WORLD! THEY ARE 100 % GUARENTEED TO WORK IN EVERY COUNTRY. THEY HAVE THE OPTION ALSO TO RUN ALL JAPANESE GAMES AS WELL.

(CURRENT OWNERS OF OUR JAPANESE CONVERTOR CAN "TRADE UP" TO THE NEW SYSTEM).

**AMERICAN TITLES INITIALLY AVAILABLE ARE:-**

BUBBLE BOBBLE  
SKY SHARK  
TARGET RENEGADE  
ROBOCOP  
1943  
CONTRA  
AFTERBURNER  
DOUBLE DRAGON  
PACMAN  
TOOBIN

MEGAMAN II  
LEGEND OF ZELDA II  
LIFEFORCE (GRADIUS 2)  
GRADIUS II (GRADIUS 3!!)  
GAUNTLET  
SUPERSPRINT  
NINJA DRAGON  
ROLLING THUNDER  
XYBOTS  
ALIEN SYNDROME

THIS IS THE NONTENDO GAME CONVERSION THAT BREAKS THROUGH THE SYSTEM BARRIERS !!

(FULL DETAILS SENT ON REQUEST WITH SAE)

WE CAN CONVERT EVERY GAME TO RUN ON "DIMENSION PLUS" IN EVERY NINTENDO SYSTEM IN THE WORLD!

## NINTENDO GAME BOY/ATARI LYNX

FULL DETAILS WITH SAE

DELIVERY OF ALL AVAILABLE ITEMS BEFORE CHRISTMAS

ALL MAJOR CREDIT CARDS TAKEN

## MENTION TECHNICAL SERVICES

0803 606146

PO BOX 18, HELENSBURGH.

ALL MENTION PRODUCTS NOW HAVE A FULL ONE YEAR GURANTEE AND ENGLISH INSTRUCTIONS!



# GREAT DEALS!

Christmas is coming and your friendly local computer dealer is trying all the arts of friendly persuasion to get you into his shop and sell you some nice software. And with offers like this going down are you foolish enough to resist?

## BOOTS UP THE WINNERS

Two for the price of one ... maybe your mind is turning towards treating yourself to a compilation this Christmas. If you buy US Gold's Winners package (all formats: contains Thunderblade, Blasteroids, LED Storm, Impossible Mission II, (8-bit only) Indiana Jones and the Temple of Doom) from any software department in Boots, you'll find an order form inside the box entitling you to a free Kixx game.

Send the form off to US Gold before the end of January and your choice of game will plunk through the letter box a few days later. Amiga and ST owners, be warned: Kixx games are 8-bit only. But if US Gold's Moonwalker is on your wants list, stroll

into Boots to buy it, and you'll get a £1 voucher which you can put towards the cost of any Michael Jackson CD, record or tape.

## BADGED SOFTWARE

Staying with Michael Jackson and Moonwalker, but moving on to your local W H Smith or John Menzies. No vouchers, but there's a nice fat Michael Jackson badge with every copy of Moonwalker bought in these outlets.

## GOODIES AND GIVEAWAYS IN THE NORTH AND MIDLANDS,

The games chain Microbyte seems to be practically giving software away. In a wild display of seasonal goodwill, there are prizes, draws and T-

shirts on a number of major titles. Should you buy Onslaught, The Untouchables, Robocop, Ghostbusters II or Hard Drivin' from Microbyte, don't, whatever you do, forget to pick up your competition entry form. Once filled in, this form will be entered into a Microbyte grand draw.

Prizes are Untouchables and Robocop videos for buyers of those games and £50 software vouchers with Onslaught. First prizes for Hard Drivin' and Ghostbusters buyers are software vouchers for a massive £200, and Ghostbusters runners-up will get free Odeon cinema tickets. Get to the front of the queue and there are further freebies on offer: a free T-shirt or poster when you buy Onslaught; an A1 poster to go with

Ghostbusters II; the exclusive Domark goodie bag with Hard Drivin', but stocks on all these will be limited.

## HERE WE GO, HERE WE GO

Live in the Liverpool area? Check out your local Bits and Bytes store when buying your US Gold games because there is a big competition going on between the store and USG. It'll be your chance to win a season ticket at either Anfield or Goodison Park, so it's well worth entering.

## VIRGIN VOUCHERS

Christmas always leaves a gaping hole in your wallet, but if you buy your presents from any Virgin outlet (Games Centres, Megastores, whatever) the special Virgin voucher

offer might ease the strain a bit. Buy any product to the value of £10 or more, before Christmas, and you will get a book of vouchers, in various denominations, adding up to £5. These can be redeemed any purchases at any Virgin store. Can't be bad.

There are Microbyte stores in the Arndale Centre, Manchester; Goosegate, and the Broadmarsh Centre, Nottingham; Kirkgate, Wakefield; the Metro Centre, Gateshead; the Greenmarket, Newcastle Upon Tyne; the Kirkgate Centre, Bradford; the Bull Ring Centre, Birmingham; and the County Arcade, Leeds. One of these must be near you! Virgin has its Games Centre outlets on London's Oxford Street (at Marble Arch, within the Megastore, and at no 100)

and Bristol, and also in Megastores in Birmingham, Brighton, Dublin, Edinburgh, Glasgow (at Union St and Argyle St), Leeds, and Nottingham.

All offers and promotions are subject to availability of stock. Although we do our best to ensure our dealer promotion information is accurate at the time of going to press, ACE cannot take any responsibility for changes or cancellations to dealers' plans.

## ATTENTION DEALERS!

Don't keep your promotions, competitions, special offers, etc, a secret. Tell us at ACE and we'll tell everybody else.

# ACE DEALERS FORM

Dealers – don't keep our readers in the dark: you want to sell, they want to buy. it's the perfect relationship. Send details of your promotions and events to us, and we'll let everyone know about them. Just fill in the form and send it with your press pack to: ACE DEALERS PAGE, Priory Court, 30-32 Farringdon Lane, LONDON EC1R 3AU

COMPANY.....  
 ADDRESS .....

TELEPHONE ..... FAX .....

PROMOTION/EVENT .....

.....



# THE ACE CHRISTMAS PRESENT...

For 8-bit owners who want to upgrade to ST or Amiga...

For 16-bit owners who want a memory upgrade, external floppy, or colour printer bargain...

## Yes, it's true!

Every ACE reader can get £20 off his or her Christmas present simply by using the vouchers below. We've negotiated this special deal with Shekhana Computers. You can find out more by either calling at their shop or telephoning (details below). Your purchase can be made either by mail order or in person. The offer expires on January 30th 1990, so don't be late!

Voucher Number One will give you £20 off either an ST or Amiga. Check the telephone number on the voucher for current prices to which the discount will apply.

Number Two will give you £20 off any one of the following:

- an Amiga or ST 0.5Mbyte RAM upgrade (normal discount price £100, yours for £80 with the ACE Voucher)
- an ST or Amiga external floppy drive for only £80, with the voucher.

### Voucher Number One

This voucher entitles the bearer to £20 off either an ST or Amiga when purchased from Shekhana Computer Services.

Only one voucher per household. Offer expires January 30th 1990.

The voucher may be redeemed in person at:

2 Gladstone House,  
High Road,  
Wood Green,  
London N22 (opposite Top Rank club)  
Tel: 01-889 9412.

or by mail-order from:

Shekhana ACE Voucher Offer  
655 Green Lanes  
London  
N8 0QY  
Tel: 01-340 8565 or 01-348 2907

### Voucher Number Two

This voucher entitles the bearer to £20 off any ONE of the following:

- an LC10 printer (usual price £199.99);
- an LC24 colour printer (usual price £270.00)
- an ST or Amiga 0.5Mbyte RAM upgrade (usual price £100)
- an ST or Amiga external floppy disk drive (check by telephone for current normal price);

Only one voucher per household. Offer expires January 30th 1990.

The voucher may be redeemed in person at:

2 Gladstone House,  
High Road,  
Wood Green,  
London N22 (opposite Top Rank club)  
Tel: 01-889 9412.

or by mail-order from:

Shekhana ACE Voucher Offer  
655 Green Lanes  
London  
N8 0QY  
Tel: 01-340 8565 or 01-348 2907



**SHEKHANA COMPUTERS**

Software Title	ATARI ST	CBM	AMIGA
3D Pool	15.99	15.99	
Altered Beast	15.99	15.99	
A-Max + Roms		249.99	
Balistics	15.99	15.99	
Balance Power 90	19.99	19.99	
Barbarian II	19.99	19.99	
Basic ST		69.99	
Batman-Movie	15.99	15.99	
Battle Chess	19.99	19.99	
Battle Valley	15.99	15.99	
Battlehawk 1942	19.99	19.99	
Beach Volley	15.99	19.99	
Beyond Zork	19.99	19.99	
Blood Wyck	15.99	19.99	
Boxing Manager	15.99	19.99	
Bridge Player 2000	15.99	15.99	
Cabel	15.99	19.99	
Chamber of Shaolin	15.99	19.99	
Chase HQ	15.99	19.99	
Chessmaster 2000	19.99	19.99	
Colossus Chess 4	19.99	19.99	
Commando	15.99	15.99	
Continental Circus	15.99	15.99	
Corruption	19.99	19.99	
C-Light		39.99	
Day of the Viper	19.99	19.99	
Deluxe Paint 2		39.99	
Deluxe Scrabble	15.99	19.99	
Debut	19.99	19.99	
Deluxe Paint III		69.99	
Deluxe Photolab		59.99	
Deluxe Productions		129.99	
Double Dragon II	15.99	15.99	
Dragon Spirit	15.99	15.99	
Dragons of Flame	19.99	19.99	
Day of Pharaoh	19.99	19.99	
Dungeon Master	19.99	19.99	
D-Master-Editor	9.99	9.99	
Emlyn Hughes	15.99	15.99	
Eye of Horus	19.99	19.99	
F16 Falcon	19.99	23.99	
F16 Combat Pilot	19.99	19.99	
Falcon-Mission	15.99	15.99	
Fast Lane	15.99	15.99	
Fast St Basic	39.99		
Ferrari Formula 1	19.99	19.99	
Fighter Bomber	23.99	23.99	
Fighting Soccer	15.99	19.99	
First World Plus	69.99	15.99	
Flight Sim 2	27.99	27.99	
Foot Director II	15.99	15.99	
Foot Manager 2	15.99	15.99	
F-Man 2-Expansion	9.99	9.99	
Galaxy Force	15.99	19.99	
Games-Summer	19.99	19.99	
Ghouls + Ghosts	15.99	19.99	
Ghostbusters II	19.99	19.99	
Giants	23.99	23.99	
Grag Norman-Golf	19.99	19.99	
Hard Drivin	15.99	15.99	
Hawaiian Scenery	15.99	15.99	
Hillstar	19.99	19.99	
Home Accounts	23.99	23.99	
Home Office Kit		134.99	
Horse Racing		19.99	
Interphase	23.99	23.99	
John Lowe Darts	15.99	15.99	
Kick Off	15.99	15.99	
Kick Off Extra	7.99	7.99	
Kindreds V2		39.99	
Laser Squad	15.99	15.99	
Micropro Soccer	19.99	19.99	
Midi Studio	89.99		
Mini Office-Comm	19.99		
Mini Office-Spread	19.99		
Moon Walker	15.99	19.99	
Music X		199.99	
Nevermind	15.99	15.99	
Ninja Warrior	15.99	15.99	
Oil Imperium	19.99	19.99	
Onslaught	19.99	19.99	
Operation Thunderbolt	15.99	19.99	
Operation Wolf	15.99	19.99	
Paperboy	15.99	15.99	
Photom Paint	19.99	19.99	
Pictionary	19.99	19.99	
Player Manager	15.99	15.99	
Pools of Radiance	23.99	23.99	
Poulous	19.99	19.99	
Populous Scenery	8.99	8.99	
Power Drift	15.99	19.99	
Protest	19.99	19.99	
RAC Rally	19.99	19.99	
Rally Cross	15.99	15.99	
Red Storm Rising	19.99		
Rock n Roll	15.99	15.99	
Red Lightning	23.99	23.99	
Ringside	19.99	19.99	
Robocop	15.99	19.99	
Rocket Ranger	19.99	23.99	
Roger Rabbit		19.99	
RvF Honda	19.99	19.99	
Saint + Greaves	15.99	15.99	
Shinobi	15.99	15.99	
Shuttlepack Cafe	15.99	15.99	
Skidz	15.99	15.99	
Slayer	15.99	15.99	
Space Ace		34.99	
Speed Ball	19.99	19.99	
ST Replay 4	69.99		
Star Command	23.99	23.99	
Star Wars Trilogy	19.99	19.99	
Starglider 2	19.99	19.99	
Starter Kit		59.99	
Steel	15.99	15.99	
Stellar Crusade	27.99	27.99	
Story so Far	15.99	15.99	
Story so Far 3	15.99	15.99	
Story so Far 4	15.99	15.99	
Stos	24.99		
Stos 600 Sprites	12.99		
Stos Compiler	15.99		
Stos Maestro	19.99		
Stos Maestro Plus	59.99		
Strider	15.99	19.99	
Stun	15.99	15.99	
Studio 24	19.99	19.99	
Stunt Car Racer	19.99	19.99	
Super Wonderboy	15.99	19.99	
Test Drive II	19.99	19.99	
The Beast		27.99	
The Untouchables	15.99	19.99	
Toadain	15.99	15.99	
Track 24		84.99	
Triad-Compilation	23.99	23.99	
Turbo Outrun	15.99	19.99	
T-Pursuit-New	15.99	15.99	
TV Sports	19.99	23.99	
Ultima 3	19.99	19.99	
Ultima 4	19.99	19.99	
Virus Killer	9.99	9.99	
War Middle Earth	15.99	15.99	
Waterloo	19.99		
Wicked	19.99	19.99	
Winners - US Gold	23.99	23.99	
Workbench 1.3		14.99	
Xenon II	15.99	15.99	
Xenophobe	19.99	19.99	
Xybots	15.99	15.99	
X-Cad Designer		99.99	

**SPECIAL OFFERS WHILE STOCKS LAST:**

JVC 3.5" DSDD 135TPI Disks x 10	£8.99
JVC 3.5" DSDD 135TPI Disks x 100	£79.99
Sony 3.5" DSDD Disks x 10	£9.99
Sony 3.5" DSDD Disks x 100	£89.99
JVC High Density 3.5" x 10	£22.99
Sony Unbranded 3.5" DSDD Disks x 10	£7.99
Sony Unbranded 3.5" DSDD Disks x 100	£59.99
JVC 5.25" DSDD box of 10	£6.99
JVC 5.25" DSDD x 100	£59.99
JVC 5.25" High Density box of 10	£10.99
Maxell 5.25" High Density DSHD x 10	£10.99
Unbranded 5.25" DSDD x 10	£4.99
Maxell 3" CF2 box of 10	£24.99
Quick Shot II Joystick	£7.99
Quick Shot II Turbo Joystick	£9.99
Commodore C64 Light Fantastic Pack	
<i>Ideal Xmas Present</i>	only £149.99
Star LC-10 Printer	£179.99
Commodore 1541-11 Disk Drive	£149.99
Sinclair +2 Computer	£149.99
Sinclair +3 Computer	£199.99
Atari ST Power Pack	£399.99
1084 Commodore Monitor	£299.99

**SHEKHANA COMPUTERS**

PC Engine - or Scart Plus Control Pad +Power Supply	
Scart Lead + One Year Guarantee + 1 free game	£199.99
PC Engine - Pal-UK TV Plus Control Pad + Power Supply+ All Leads + One Year Guarantee + 1 free game	£199.99
CD Rom Unit + Interface Unit	£425.00

Joystick XE-1 HE-PRO	£69.99
Joystick XE-I ST	£39.99
Joypad Control Unit	£19.99
AV Booster for Hi-Fi	£34.99
5-Player Adaptor	£29.99
PC-UK Power Supply	£14.99

**PC ENGINE SOFTWARE TITLES AVAILABLE NOW:**

Altered Beast	£34.99
Baseball Namcot	£29.99
Break In	£34.99
Chan + Chan (Kato Ken)	£24.99
Bloody Wolf	£34.99
Deep Blue	£34.99
Dragon Spirit	£27.99
Drunken Master	£24.99
Dungeon Explorer	£34.99
F1-Pilot-Car Racing	£34.99
Digital Champ	£34.99
Final Lap	£34.99
Fire Pro Wrestling	£34.99
Galaga 88	£29.99
Legendary Axe	£29.99
Motor Roder	£29.99
Ordnyne	£34.99
Ninja Warrior	£34.99
Overhauled Man	£34.99
Pacland	£29.99
Power Baseball	£29.99
Power Golf	£34.99
P-47	£34.99
R-Type 1	£29.99
R-Type 2	£29.99
Rock On	£34.99
Sidearms	£34.99
Son Son II	£34.99
Space Harrier	£29.99
Tales of Monsterpath	£24.99
Tiger Heli	£34.99
Victory Run	£29.99
Vigilante	£29.99
War of the Dead	£34.99
Watwru	£34.99
Winning Shot-Golf Game	£34.99
Wonder Momo	£34.99
Wonderboy	£24.99
World Court Tennis	£29.99
Yaksa	£34.99

SPEC SOFTWARE TITLE	SPEC CASS	C64 DSK	C64 CASS	AMS DSK	AMS CASS	DSK
100% Dynamite	11.99	—	11.99	D4	11.99	D4
Airbourne Ranger	7.99	D3	11.99	D5	11.99	D5
Artist II-128k	14.99	—	—	—	—	—
Barbarian II	7.99	D3	7.99	D3	7.99	D3
Batman-Movie	7.99	D3	7.99	D3	7.99	D3
Bloodwyck	7.99	D3	7.99	D2	7.99	D3
Boxing Manager	7.99	—	7.99	D3	7.99	D3
Cabel	6.99	D3	7.99	D3	7.99	D3
Chamber of Shaolin	—	—	7.99	D3	—	—
Championship Golf	7.99	—	—	—	—	—
Chase HQ	7.99	D3	7.99	D3	7.99	D3
Continental Circus	7.99	D3	7.99	D3	7.99	D3
Double Dragon II	7.99	D3	7.99	D3	7.99	D3
Dragon Spirit	7.99	D3	7.99	D1	7.99	D3
E-Hughes Soccer	7.99	—	7.99	D1	—	—
Fighter Bomber	11.99	—	11.99	D5	11.99	D5
Fighting Soccer	7.99	—	7.99	D3	7.99	D3
F. Director 2	14.99	D6	—	—	—	D6
F. Man 2-Expansion	6.50	D1	6.50	D1	6.50	D1
F. Manager 2	7.50	D3	7.50	D3	7.50	D3
F.O.T. Year 2	7.99	D3	7.99	D3	7.99	D3
Galaxy Force	7.99	—	7.99	D3	7.99	D3
Games-Summer	7.99	D1	—	—	7.99	D3
Ghouls + Ghosts	7.99	—	7.99	D3	7.99	D3
Ghostbusters II	7.99	—	7.99	D3	7.99	D3
Gunship	7.99	D3	11.99	D5	11.99	D5
G. Norman Golf	—	—	11.99	D5	—	—
Hard Driving	7.99	D3	7.99	D1	7.99	D3
J. Lowe Darts	—	—	7.99	D3	—	—
Kick Off	7.99	D3	7.99	D3	7.99	D3
Laser Squad	7.99	D5	7.99	D5	7.99	D5
Moonwalker	7.99	D3	7.99	D3	7.99	D3
Ninja Warrior	7.99	D3	7.99	D3	7.99	D3
Operation Thunderbolt	7.99	D3	7.99	D3	7.99	D3
Player Manager	7.99	D3	7.99	D3	7.99	D3
Power Drift	7.99	—	7.99	D3	7.99	D3
Rally Cross	7.99	D3	7.99	D3	7.99	D3
Robocop	7.99	D3	7.99	D3	7.99	D3
Rock n Roll	6.99	D3	7.99	D3	7.99	D3
Shinobi	7.99	D3	7.99	D3	7.99	D3
Silkworm	7.99	—	7.99	—	7.99	D3
Stealth Fighter	7.99	D3	11.99	D5	11.99	D5
Stryder	7.99	—	7.99	D3	7.99	D3
Stunt Car Racer	—	—	7.99	D3	—	—
Super Scramble	7.99	D3	7.99	D3	7.99	D3
Super Wonderboy	7.99	—	7.99	D3	7.99	D3
The Hits	—	—	9.99	D4	—	—
The Untouchables	7.99	D3	7.99	D1	7.99	D3
Toobin	7.99	D3	7.99	D1	7.99	D1
Turbo Outrun	7.99	—	7.99	D3	7.99	D3
Winners - US Gold	9.99	D3	9.99	D3	9.99	D4
Xenophobe	7.99	D3	7.99	D3	7.99	D3

Also Available on Disk Format:  
D1 = 9.99, D2 = 11.99, D3 = 12.99, D4 = 14.99, D5 = 15.99.

**AMIGA A500** Including Workbench 1.3, Amiga Extras, Amiga Basic, Manuals, A500 512k, Keyboard with built in 1 Megabyte 3.5" Disk Drive. Plus 'The Very First' step by step Tutorial Disk, plus Mouse Controller, Power Supply, All leads and connectors included. Either Modulator for Connection onto a TV or a Scart Cable for use with Monitor.  
**ONLY £359.99**

**BAT PACK**, as above but with extra Batman the Movie Game, The New Zealand Story Game, Interceptor, Deluxe Paint II  
**ONLY £399.99**

**SEGA 16 - BIT MEGADRIVE**

**Sega 16 Bit + Scart Version**  
Power Supply, Scart Lead, Control Pad, One Year Guarantee + 1 free game  
**£199.99**

**Sega 16-Bit + PAL TV Version, Power Supply, Control Pad, TV Lead, One Year Guarantee + 1 free game**  
**£199.99**

Alex Kidd	£29.99
Altered Beast	£34.99
Space Harrier II	£34.99
Super Thunderblade	£34.99
Thunderforce II	£34.99
Superleague Baseball	£44.99
Super Hang On	£44.99
Heavy Unit	£44.99
Rambo 3	£44.99
World Cup Soccer	£34.99
Ghouls and Ghosts	£44.99
Master Golf	£44.99

**NINTENDO GAMEBOY**

Gameboy + Headphones	£99.99
Alleyway	£27.99
Baseball	£27.99
Beach Volleyball	£27.99
Dracula	£27.99
Dragon Spirit	£27.99
Holy Drive	£27.99
Mario Land	£27.99
Mickey Mouse	£27.99
Motorcross	£27.99
Operation Wolf	£27.99
Pinball	£27.99
Super Mario Land	£27.99
Tennis	£27.99
Tetris	£27.99
Tetris	£27.99







# COMPO RESULTS

## PSUPER PSYGNOSIS PSTUFF

The following five lucky people are the winners of our **Psygnosis Special!** compo, which we ran in our November Issue. All will be receiving copies of Triad, Blood Money, Never Mind, Infestation, Matrix Marauders, and Stryx, as well as the very classy Psygnosis T-shirt and Roger Dean's Beast T-shirt:

**Mark Fletcher**, Stoke-on-Trent, Staffordshire; **Mark Shaw**, Cannock, Staffs; **B.Whittle**, Consett, Co-Durham; **D.Wooring**, Bleiswijk, Holland; **Bobby Chaggar**, Milton Keynes, Buckinghamshire.

## BOMBS AWAY!

Back in our October issue we ran a competition in conjunction with Activision to celebrate the impending launch of their superb flight simulator, *Bomber*.

The winner who receives (wait for it) a whole £600 of flying lessons, in addition to a copy of the game, is **P.Maskell**, of Watford.

Twenty runners-up, who all receive copies of the game are: **Richard M. Gardner**, Hambleton, Selby; **Graeme Harvey**, Lenzie, Glasgow; **Neill Edwards**, Chichester, W.Sussex; **T.Way**, Christchurch, Dorset; **Peter Scott**, Bedlington, Northumberland;

**Mr.S.D.Walden**, Chatham, Kent; **Mark Baker**, Borehamwood, Herts.; **Richard Elder**, Lisburn, County Antrim, Northern Ireland; **Christopher Walton**, Lostock, Bolton; **Mr. N.S.Barnett**, Leigh-on-Sea, Essex; **Peter Young**, Saddlesworth, Lancs.; **Gareth Howlett**, Orton Wistow, Peterborough; **Damion Pickup**, Scarborough, N.Yorks; **Miss Alison Gay**, Edinburgh; **K.M.Ford**, Ottery St.Mary, Devon; **Mr.Martin Cross**, Bradford, West Yorkshire; **Steve Wood**, Penn, Wolverhampton; **Mr. B.Baker**, Firwood, Manchester; **Mr. S.Allen**, Pontefract, West Yorkshire, and **Paul D. Hepple**, Choppington, Northumberland.

# T.C. COMPUTERS

TEL: (02357) 60177

## ★ PC SPECIAL PRICES ★



- Commodore PC-10 111, SD, Mono ..... £580
- Commodore PC-10 111, DD, Mono ..... £699
- Commodore PC-20 111, SD, 20Mb HD, Mono ..... £785
- Commodore PC-20 111, SD, 20Mb HD, EGA ..... £1099
- Commodore PC-30 111, SD, 20Mb HD, Mono (AT) ..... £1130
- Commodore PC-40 111, SD, 40Mb HD, VGA, Mono (AT) EPOA

- Amiga A500/TV Modulator - Bat Pack ..... £359
- Amiga A500/TV Modulator - Ten Star Pack ..... £379
- Amiga A500/TV Modulator - 2nd Disk Drive ..... £439
- Amiga A500/TV Modulator - 1Mb Ram ..... £489
- Amiga A500 - Colour Monitor ..... £579

- Star LC-10 Mono ..... £155
- Star LC-10 Colour ..... £196
- Star LC24-10 Mono ..... £259
- Star LC24-15 Mono ..... £259
- Star LC-10 2 Mono ..... EPOA
- Star LC-15 Mono ..... £299
- Star XB24-10 Mono ..... £440
- Star XB24-15 Mono ..... £579

## Printers



For 1 year on-site warranty on Star Printer add £10.

- Citizen 180E ..... £149
- Citizen HQP-40 ..... £349
- Citizen Swift ..... £289
- Citizen Swift Colour ..... £325
- Citizen Swift Pro Dot 9 ..... EPOA
- Mansman Tally MT81 ..... £129

- 3 1/2 DS DD Disks (1 for 1 guarantee) 10's ..... £9.00
- 3 1/2 DS DD Disks Sony Boxed in 10's ..... £11.99
- 3 1/2 DS DD Disks Commodore in 10's ..... £14.99

ALL PRICES INCLUDE VAT AND ARE SUBJECT TO CHANGE WITHOUT NOTICE  
Software up to 30% off RRP



12A BARNARDS WAY  
CHARLTON HEIGHTS  
WANTAGE, OXON. OX12 7EB



01-803 0893  
Computers

NEW SHOP: 28A WESTERHAM AVE, LONDON. N9 4BU

AMIGA			ATARI ST		
<b>BATMAN PACK</b> A500 + Free modulator + Batman the Movie + £100 worth Software <b>£364.99</b>	<b>EXPANSION PACK</b> Batman Pack + 1/2 Meg Ram + Dragons Lair <b>£479.99</b>	<b>EXPLORER PACK</b> 520 STFM + Ranarama Game + Disk Accessories <b>£269.99</b>	<b>POWER PACK</b> 520 STFM + £550 software inc Afterburner <b>£344.99</b>		
16 Day Free Hotel Accommodation with above			Limited Quantity: "Hyper Packs" Free with above		
<b>CHRISTMAS SPECIAL: Send this advert with your order and deduct £5 from above prices</b>					
100% Guaranteed 3 1/2 DD/DS			Speedking (Auto) ..... £8.99		
10: £7.95 50: £32.99 100: £60.99			Pro 5000 ..... £10.99		
ALL DISCS BOXED IN 10'S (NOT BULK PACKED)			Philips CM8833/Panasonic 1081.. £Best Price		
<b>Spec</b>	<b>C64</b>	<b>Ams</b>	<b>ST</b>	<b>AMIGA</b>	
Altered Beast ..... 7.25	7.25	7.25	13.79	16.79	
Batman - The Movie ..... 6.90	6.90	6.90	12.79	15.79	
Bomber ..... 10.75	10.75	10.75	20.49	20.49	
Cabal ..... 6.90	6.75	6.75	12.79	15.79	
Chase HQ ..... 6.75	6.75	6.75	12.79	15.79	
Continental Circus ..... 6.95	6.95	6.95	12.99	12.99	
Double Dragon 2 ..... 6.95	6.95	6.95	15.79	15.79	
Dragon Ninja ..... 6.50	6.75	6.75	12.99	12.99	
Dynamite Dux ..... 7.25	7.25	7.25	13.79	16.79	
Fighting Soccer ..... 7.25	7.25	7.25	15.79	15.79	
Forgotten Worlds ..... 7.25	7.25	7.25	13.79	16.79	
Epic Action ..... 10.75	10.75	10.75	13.79	16.79	
Galaxy Force ..... 7.25	7.25	7.25	13.79	16.79	
Ghouls and Ghosts ..... 7.25	7.25	7.25	15.99	15.99	
Ghostbuster 2 ..... 7.25	7.25	7.25	15.79	15.79	
Hard Drivin ..... 6.99	6.99	6.99	15.99	15.99	
E. Hughes Int Soccer ..... 6.75	6.75	6.75	12.79	12.79	
Mr Hell ..... 6.99	6.99	6.99	15.79	15.79	
Moonwalker ..... 7.25	7.25	7.25	16.79	16.79	
New Zealand Story ..... 6.50	6.75	6.75	12.79	15.79	
Ninja Warriors ..... 6.99	6.99	6.99	12.99	12.99	
Operation Thunderbolt ..... 6.75	6.75	6.75	12.79	15.79	
Power Drift ..... 7.25	7.25	7.25	13.79	13.79	
Robocop ..... 6.50	6.75	6.75	12.79	15.79	
Shinobi ..... 6.99	6.99	6.99	16.79	16.79	
Strider ..... 7.25	7.25	7.25	15.79	15.79	
Super Wonder Boy ..... 7.25	7.25	7.25	12.79	15.79	
The Untouchables ..... 6.75	6.75	6.75	phone	21.99	
Toobin ..... 6.99	6.99	6.99	12.99	12.99	
Turbo Outrun ..... 7.25	7.25	7.25	13.79	13.79	
Winners ..... 10.75	10.75	10.75	15.99	15.99	
100% Dynamite ..... 9.99	9.99	9.99	13.79	16.79	
			12.79	15.79	
			12.99	12.99	
			13.79	16.79	
			16.79	16.79	
			20.49	20.49	
			15.99	15.99	

**PC Engine 'Plus' - Quality Machine**  
**SEGA MAGADRIE NOW IN-**  
**PAL (TV Compatible) at best prices**  
Software from £29.99

To avoid disappointment for Christmas - Hardware can be personally delivered by us in and around the M25 area at no extra cost.  
Hardware: Available at above prices from our shop  
Software: Available at 20-25% off RRP (on production of advert)  
When ordering a combination of Hardware/Software ring for special price.

## SOUTH EAST KENT SOFTWARE

78 SOUTHFLEET ROAD, ORPINGTON, KENT.  
TEL: 0689 50204

**New! ATARI 520 STFM POWER PACK**  
INCLUDES 23 GAMES WORTH £500.00.  
FREE HYPER SOFTWARE PACK.  
ALL THIS FOR: **£344.95**

**New! BATMAN AMIGA 500 PACK**  
INCLUDES FREE DUST COVER + FREE POSTER  
BUY NOW SAVE £££'s: **£359.00**

**New! COMMODORE AMIGA EDUCATION PACK**  
ONLY: **£500.00**

**30% OFF ATARI/AMIGA GAME PRICES.**  
DISCOUNT ON SEGA AND NINTENDO  
**20% OFF JOYSTICKS.**

- New! COMP PRO DAY GLO RED OR GREEN** ..... £16.00
- QUICKSHOT 2 TURBO ..... £9.95
- SPEEDKING AUTOFIRE ..... £9.95

SEND FOR FULL LIST.

- 10 x 3.5" DSDD 135TPL ..... £7.20
- 50 x 3.5" DSDD 135TPL ..... £32.50

BLANK BULK DISKS

**PAYMENT PAYABLE TO: J. FERGUSON BY CHEQUE**



# PRIZE PUZZLE

Set by Archie Medes

To herald in the 1990's, here's a crossnumber puzzle based on the current year. As you can see, this number has already been entered at 3 across (that's the easy bit). Your task is to find two values, A and B, such that the expressions given will also fit into this grid.

Incidentally, if you try this before the new year, it's no use putting '1989' in at 3 across. If you do, there is no solution possible.

### The Clues

- Across**  
 3) The current year  
 4) B  
 5) A  
 6) A times B

- Down**  
 1) A squared  
 2) B squared

### A quick note for puzzlers

We are hoping to increase the number and variety of puzzles appearing in these pages. If you have any comments or ideas that you would like to put forward on Pink Page Puzzles, write to us at: **ACE Magazine, 30-32 Farringdon Lane, London. EC1R 3AU.**

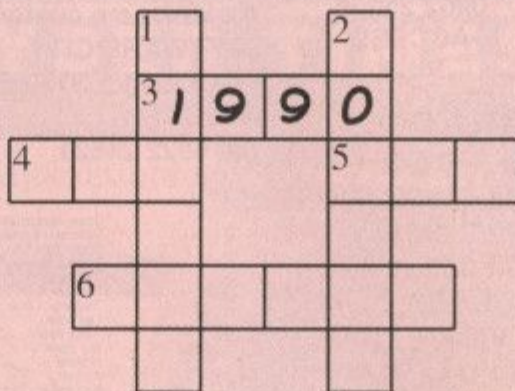

## PRIZE PUZZLE JANUARY 1990 ENTRY FORM

Name:.....

Address:.....

Telephone:..... Listing enclosed (optional):

Completed entry forms should be sent to: ACE Jan '90 Prize Puzzle, 30-32 Farringdon Lane, London. EC1R 3AU, by 7/1/90.

### Results

Because of our little hiccup with the November puzzle (which meant printing it again and extending the deadline), there are no results this month.

But, never fear, the results for the previous two puzzles will be printed in the February edition.

Please note that puzzles are now referenced by month and year, not number.

February will also see the return of the much missed ACE Prize Crossword. So all you word addicts out there will soon be able to get your fix again in your favourite Computer Monthly.

MONTHLY PAYMENT TERMS ARE NOW AVAILABLE THROUGH LOMBARD TRICITY FINANCE ON ALL PURCHASES OVER £150.00. PLEASE RING FOR DETAILS

**ATARI 520STFM**

\*\*\*\*\*  
 \* **FREE!! WITH ALL ATARI** \*  
 \* **COMPUTERS HYPER PAINT,** \*  
 \* **HYPER DRAW, BORODINO** \*  
 \* **ONLY WHILST** \*  
 \* **STOCKS LAST** \*  
 \*\*\*\*\*

**NEW!! POWER PACK PACK A**

Atari 520STFM with 1MB Disc Drive Mouse, 20 Game Software Pack, Business Organiser, First Basic, Basic Guide, First Music, Owners Handbook, Atari Joystick

**ONLY £359.95**

**PLUS FREE!!** A Superb Starter Pack including Wordprocessor, Spreadsheet, Word Count, Spellchecker, Neochrome, Mono Monitor Emulator, Database, Towers of Hanoi, Pacman, Sensori, Fruit Machine Simulation, Mouse Mat.

**PACK B**

**CONTAINS ALL ITEMS IN PACK A PLUS !!**

Vinyl Computer Cover, Disk Cleaner Lockable Disc Box - Holds 80 Disks, Twin Joystick Extension Lead, Ten DS/DD Disks, 2nd Joystick

**ONLY £389.95**

**PLUS FREE!!** Our Superb Starter Pack as detailed in Pack A above.

**PACK C**

**CONTAINS ALL ITEMS IN PACK A PLUS !!**

A Philips CM8833 Colour Monitor with Connecting Lead

**ONLY £579.95**

**PLUS FREE!!** Our Superb Starter Pack as detailed in Pack A above

**ATARI 520STFM EXPLORER PACK**

**ATARI 520STFM with 1mb DRIVE**  
 Mouse, owners manual, sourcebook and tutorial, UK Basic Ranarama Game, Tutorial disk

**ONLY £279.95**

**PLUS FREE!!** Our Superb Starter Pack as detailed in Pack A Above

**COMPUTERS**  
**COMMODORE AMIGA A500**

**NEW!!! MEGA PACK**

Commodore Amiga A500, Mouse, Workbench 1.3, Workbench Extras, Very First Tutorial Disk, Owners Handbook, Basic Handbook, TV Modular, Mouse Mat, Beyond The Ice Palace, Buggy Boy, Ikari Warriors, Battleships, Xenon, Captain Blood, Arkanoid 2, Crazy Cars, Thundercats, Bomb Jack, Space Harrier, Live And Let Die, Microwitch Joystick

**ONLY £399.95**

Including VAT, Delivery and Plug. Hurry Limited Stock of this Pack

**NEW! THE MOVIE PACK**

Commodore Amiga A500, Mouse, Workbench 1.3, Workbench Extras, Very First Tutorial Disk, Owners Handbook, Basic Handbook, TV Modulator, Mouse Mat, **PLUS!!** Deluxe Paint 2, F18 Interceptor, New Zealand Story, Batman

**ONLY £369.95**

Including VAT, Delivery and Plug.

**NEW! THE MOVIE + PACK**

Commodore Amiga A500, Mouse, Workbench 1.3, Workbench Extras, Very First Tutorial Disk, Owners Handbook, Basic Handbook, TV Modulator, Mouse Mat, **PLUS!!** Deluxe Paint 2, F18 Interceptor, New Zealand Story, Batman, **PLUS!!** Ten Blank Discs, Disk Storage Box - Holds 80 disks, Joystick, Vinyl Cover.

**ONLY £389.95**

Including VAT, Delivery and Plug.

**MOVIE MONITOR PACK**

Comprises all items as listed in The Movie Pack above **PLUS!!** A Philips CM8833 Colour Stereo Monitor with connecting Lead

**£589.95**

No TV Modulator in this Pack

**ACCESSORIES**  
**PRINTERS**

\*\*\*\*\*  
 \*\* Star LC10 Printer \*\*  
 \*\* ONLY \*\*  
 \*\* £169.95 \*\*  
 \*\* WHILST STOCKS LAST \*\*  
 \*\*\*\*\*

Star LC10 Colour Printer  
 ONLY  
 £209.95

WHILST STOCKS LAST

\*\*\*\*\*

Panasonic KXP1081 £169.95  
 Panasonic KXP1124 £295.00  
 Amstrad DMP2160 £159.95  
 Citizen 120D £138.00  
 Citizen 180E £158.00  
 Citizen HQP 45 £369.95  
 Star LC10/24 £259.95  
 Seikosha SP1200 £129.95

ALL PRINTER PRICES INCLUDE CONNECTING LEAD

**MONITORS**

\*\*\*\*\*  
 \*\* Philips CM8833 \*\*  
 \*\* Colour Monitor \*\*  
 \*\* ONLY £229.95 \*\*  
 \*\* INCLUDING LEAD \*\*  
 \*\*\*\*\*

Atari SM124 £109.95

**DISC DRIVES**

Cumana CSA354 1mb ST £94.95  
 Cumana CAX354 1mb AM £89.95  
 Mail Centa Amiga 1mb £79.95

**ACCESSORIES**

ST Mouse £24.95  
 Twin Joystick Lead £5.95  
 Mouse Mat £4.95  
 Amiga TV Modulator £14.95

**VINYL DUST COVERS**

Amiga A500 £5.95  
 Atari 520STFM £5.95  
 Atari 1040STFM £5.95  
 Philips CM8833 £6.95  
 Commodore 1084/S £6.95  
 Star LC10 £4.95  
 Citizen 120D £4.95  
 Panasonic KXP1081 £4.95  
 Commodore 64C £5.95

**PC ENGINE SOFTWARE**  
**CLEARANCE SALE**

Fantasy Zone £22.95  
 Wonderboy Monster Land £22.95  
 Vigilante £22.95  
 Drunken Master £22.95  
 Cybercross £22.95  
 Victory Run £22.95  
 Deep Blue £22.95  
 Pacland £22.95  
 R Type £22.95  
 Winning Shot £22.95  
 Moto Roader £22.95  
 Dragon Spirit £22.95  
 Dungeon Explorer £22.95

LIMITED STOCK AVAILABLE

**16 BIT SOFTWARE**  
**SPECIAL OFFERS**

	ST	AMIGA
Puffys Saga	9.95	9.95
Thunderbirds	9.95	9.95
Running Man	8.95	9.95
Fusion	8.95	8.95
Pacmania	8.95	—
SD1	5.95	—
Flying Shark	8.95	—
Corruption	6.95	—
Fish	6.95	—
Gee Bee Air Rally	—	6.95
Romantic Encounters	—	6.95
GFL Football	—	5.95
IKI	—	5.95
Roger Rabbit	—	9.95
Nebueus	—	6.95
Exolon	5.95	—
Cyberoid 2	5.95	—
Pacland	8.95	9.95
Wicked	8.95	8.95
Custodian	5.95	6.95
Manhunter	—	7.95
Police Quest	—	9.95
No Excuses	—	6.95
Powerplay	—	9.95
Quaser	—	4.95
Zynaps	4.95	—

\*\*\*\*\*  
 \*\* **SPECIAL OFFER** \*\*  
 \*\* 3.5" Double Sided \*\*  
 \*\* Double Density Disks \*\*  
 \*\* 50 For **ONLY £34.95** \*\*  
 \*\* **VERY GOOD QUALITY** \*\*  
 \*\*\*\*\*

MAIL - CENTA  
 17 CAMPBELL ST, BELPER, DERBY, DE5 1AP. TEL: 0773 826830

ALL prices include VAT and delivery. However for orders under £5.00 please add 50p handling charge. Personal callers welcome at our retail shop but please bring this advert as prices may vary. Closed Wednesdays. All items despatched same day whenever possible. Cheques may require a seven day clearance period. Proprietor Martin Bridges

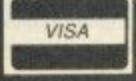



# SOFTWARE CITY

CALL US ON:  
0785 41899  
0922 24821  
0902 25304  
ACCESS  
VISA

We welcome customers at  
**SOFTWARE CITY**  
1 GOODALL STREET  
WALSALL  
Tel. 0922 24821

**SOFTWARE CITY**  
59 FOREGATE STREET  
STAFFORD  
Tel. 0785 41899

**SOFTWARE CITY**  
3 LICHFIELD PASSAGE  
WOLVERHAMPTON  
Tel. 0902 25304

CALL US ON:  
0785 41899  
0922 24821  
0902 25304  
ACCESS  
VISA

## AMSTRAD CASSETTE

180	2.99
720	2.99
1942	2.99
Academy	2.99
Ace 1 or 2	2.99
Amsoft 1 or 2	1.99
Alternative World Games	1.99
American Football	2.99
Archie Flight Sim	2.99
Arturo	1.99
Army Moves	2.99
Auf Wiedersehen Monty	1.99
Barbarian	2.99
Barry McGuigan's Boxing	2.99
Batman	2.99
Blockbusters	2.99
Bombback 1 or 2	2.99
Bruce Lee	1.99
Cauldron 1 or 2	1.99
Cholo	0.99
Cobra	2.99
Commando	2.99
Crazy Cars	2.99
Cybermad	2.99
Daley Thompson's Decathlon	2.99
Deactivators	2.99
Deep Strike	0.50
Dizzy 1 or 2 Treasure Island Dizzy	2.99
Enduro Racer	2.99
European 2 Football	1.99
Fifth Avenue	1.99
Fight Simulator	1.99
Flintstones	2.99
Football Manager	2.99
Footballer of the Year	2.99
Frank Bruno's Boxing	1.99
Frank Machine	2.99
Graham Gooch	1.99
Grand Prix Sim 1 or 2	2.99
Gauntlet 1 or 2	2.99
Ghosts	1.99
Ghosts and Goblins	1.99
Green Beret	2.99
Greg Loses his Clock	0.50
Hive	0.50
Indoor Soccer	1.99
Jack the Nipper	2.99
Jet Ski Sim	2.99
Joe Blade 1 or 2	1.99
Kinetix	1.99
Kik Start 2	0.50
Leaderboard	2.99
Leaderboard Add On	2.99
League Challenge	2.99
Lee Enfield-Amazon	1.99
Lee Enfield-Tournament	1.99
Manc Miner	2.99
Masters of the Universe	2.99
Match Point	2.99
Mega Apocalypse	1.99
Monte Carlo Casino	2.99
Moto Cross Sim	2.99
Mystery of the Nile	0.50
Netherworld	1.99
Nigel Mansell	2.99
On the Bench	2.99
Paperboy	2.99
Pepsi Mad Mix	1.99
Peter Shilton's Handball	2.99
Pinball Sim	2.99
Pink Panther	2.99
Postman Pat	1.99
Powerplay	1.99
Premier 2 Football	1.99
Pro Snooker	2.99
Rambo	2.99
Rampage	2.99
Raspurin	0.50
Rex	2.99
Rolling Thunder	2.99
Rugby Boss	1.99
Rugby Sim	2.99
Rygar	2.99
Saboteur 1 or 2	1.99
Sam Fax	1.99
Scoby Doo	1.99
Shoot Out	2.99
Short Circuit	2.99
Skate Crazy	1.99
Skool Daze	1.99
Soccer Boss	1.99
Soccer Q	1.99
Spinzy	1.99
Spiffire 40	2.99
Sport of Kings	2.99
Spy Hunter	2.99
Star Wars	2.99
Street Fighter	2.99
Summer Games	2.99
Super Cup Football	2.99
Super Cycle	1.99
Super Dragon Slayer	2.99
Superstar Soccer	2.99
Titanic	2.99
Theatre Europe	2.99
Thundercats	2.99
Top Gun	2.99
Turbo Esprit	1.99
Turf Form	2.99
Twin Turbo VB	2.99
Venom Strikes Back	1.99
Vixen	2.99
Vulcan	3.99
War Machine	2.99
Wizard Warz	2.99

## COMMODORE CASSETTE

1942	2.99
720	2.99
Ace 1 or 2	2.99
Action Force	2.99
Advanced Basketball Sim	2.99
Advanced Pinball	2.99
American Football	2.99
Amsoft 2	1.99
Barbarian	2.99
Barry McGuigan's Boxing	2.99
Bard's Tale	2.99
Battleships	1.99
Blasters	2.99
Bombback 1 or 2	2.99
Bruce Lee	1.99
Commando	2.99
Cosmic Causeway	1.99
Crazy Cars	2.99
Crocker International	2.99
Cyberoid 1 or 2	2.99
Daley Thompson's Decathlon	2.99
Deactivators	0.99
Die Alien Sime	2.99
Dizzy 1 or 2 Treasure Island Dizzy	2.99
The Double	2.99
Enduro Racer	2.99
European 2	1.99
F.A. Cup	1.99
First Past the Post	2.99
Fist 2	2.99
Cup Football	2.99
Cyberoid 1 or 2	2.99
D-Day	2.99
Daley Thompson's Decathlon	2.99
Dizzy 1 or 2 Treasure Island Dizzy	2.99
The Double	2.99
Enduro Racer	2.99
European 2 Football	1.99
F.A. Cup	2.99
First Past the Post	2.99
Flintstones	2.99
Footballer of the Year	2.99
Frank Bruno	1.99
Frankenstein	1.99
Frankenstein Jr	2.99
Frustracine Sim	2.99
Gauntlet 1 or 2	2.99
Graham Gooch	1.99
Ghosts	1.99
Gauntlet 1 or 2	2.99
Green Beret	2.99
Gunfighter	1.99
Hardball	0.50
Heavy Metal Paratroid	2.99
Helix Attack	2.99
Hollywood Poker	1.99
International Rugby Sim	2.99
Jack the Nipper 1 or 2	2.99
Joe Blade 1 or 2	1.99
Kikstart 2	1.99
Knights Games	2.99
Knighmare	2.99
Leaderboard	2.99
League Challenge	2.99
Match Point	2.99
Mic 29 Soviet Fighter	2.99
Monty on the Run	2.99
Moto Cross Sim	2.99
Nebulus	2.99
On the Bench	1.99
Passing Shot	3.99
Peter Shilton	2.99
Phobia	2.99
Pinstop 2	2.99
Postman Pat	1.99
Powerplay	1.99
Premier 2 Football	1.99
Pro Snooker	2.99
Rambo	2.99
Rampage	2.99
Rally Cross Sim	2.99
Rambo	2.99
Rampage	2.99
Return of the Jedi	2.99
Rolling Thunder	2.99
Rygar	2.99
Saboteur 1 or 2	1.99
Sam Fax	1.99
Scoby Doo	1.99
Shoot Out	2.99
Short Circuit	2.99
Skate Crazy	1.99
Skool Daze	1.99
Soccer Boss	1.99
Soccer Q	1.99
Spinzy	1.99
Spiffire 40	2.99
Sport of Kings	2.99
Spy Hunter	2.99
Star Wars	2.99
Street Fighter	2.99
Summer Games	2.99
Super Cup Football	2.99
Super Cycle	1.99
Super Dragon Slayer	2.99
Superstar Soccer	2.99
Task Force	2.99
Tetris	2.99
Theatre Europe	2.99
Thundercats	2.99
Top Gun	2.99
Turbo Esprit	1.99
Turf Form	2.99
Trapsdoor 1 or 2	2.99
Trivial Pursuit	4.99
Turf Form	2.99
Urdium	2.99
War Machine	2.99
Werewolf of London	1.99

## SPECTRUM CASSETTE

720	2.99
1942	2.99
Academy	2.99
Ace 1 or 2	2.99
Action Force	2.99
Advanced Soccer Sim	2.99
Amsoft 1 or 2	1.99
Alien Syndrome	2.99
American Football	2.99
Archie Collection	2.99
Bak To Skool	1.99
Barbarian	2.99
Bard's Tale	2.99
Barry McGuigan's Boxing	2.99
Batman	2.99
Bombback 1 or 2	2.99
Boulderdash	2.99
British Super League	2.99
Bruce Lee	1.99
Cauldron 1 or 2	1.99
Chuckie Egg 1 or 2	3.99
Commando	2.99
Contact Sam Cruise	2.99
Crazy Cars	1.99
Crocker Int	2.99
Cup Football	2.99
Cyberoid 1 or 2	2.99
D-Day	2.99
Daley Thompson's Decathlon	2.99
Dizzy 1 or 2 Treasure Island Dizzy	2.99
The Double	2.99
Enduro Racer	2.99
European 2 Football	1.99
F.A. Cup	2.99
First Past the Post	2.99
Flintstones	2.99
Footballer of the Year	2.99
Frank Bruno	1.99
Frankenstein	1.99
Frankenstein Jr	2.99
Frustracine Sim	2.99
Gauntlet 1 or 2	2.99
Graham Gooch	1.99
Ghosts	1.99
Gauntlet 1 or 2	2.99
Green Beret	2.99
Gunfighter	1.99
Hardball	0.50
Heavy Metal Paratroid	2.99
Helix Attack	2.99
Hollywood Poker	1.99
International Rugby Sim	2.99
Jack the Nipper 1 or 2	2.99
Joe Blade 1 or 2	1.99
Kikstart 2	1.99
Knights Games	2.99
Knighmare	2.99
Leaderboard	2.99
League Challenge	2.99
Match Point	2.99
Mic 29 Soviet Fighter	2.99
Monty on the Run	2.99
Moto Cross Sim	2.99
Nebulus	2.99
On the Bench	1.99
Passing Shot	3.99
Peter Shilton	2.99
Phobia	2.99
Pinstop 2	2.99
Postman Pat	1.99
Powerplay	1.99
Premier 2 Football	1.99
Pro Snooker	2.99
Rambo	2.99
Rampage	2.99
Rally Cross Sim	2.99
Rambo	2.99
Rampage	2.99
Return of the Jedi	2.99
Rolling Thunder	2.99
Rygar	2.99
Saboteur 1 or 2	1.99
Sam Fax	1.99
Scoby Doo	1.99
Shoot Out	2.99
Short Circuit	2.99
Skate Crazy	1.99
Skool Daze	1.99
Soccer Boss	1.99
Soccer Q	1.99
Spinzy	1.99
Spiffire 40	2.99
Sport of Kings	2.99
Spy Hunter	2.99
Star Wars	2.99
Street Fighter	2.99
Summer Games	2.99
Super Cup Football	2.99
Super Cycle	1.99
Super Dragon Slayer	2.99
Superstar Soccer	2.99
Task Force	2.99
Tetris	2.99
Theatre Europe	2.99
Thundercats	2.99
Top Gun	2.99
Turbo Esprit	1.99
Turf Form	2.99
Trapsdoor 1 or 2	2.99
Trivial Pursuit	4.99
Turf Form	2.99
Urdium	2.99
War Machine	2.99
Werewolf of London	1.99

Super Nudge 2000	1.99
Superstar Soccer	2.99
Super Tank Sim	2.99
Theatre Europe	2.99
Thundercats	2.99
Top Gun	2.99
Trapsdoor 1 or 2	1.99
The Train	2.99
Turbo Esprit	1.99
Turf Form	2.99
Urdium	2.99
Wizball	2.99
Wolf Pack	2.99
World Class Leaderboard	2.99
World Games	2.99
Xcultur	1.99
Yie Ar Kung Fu	2.99
Yogi Bear	1.99

## SIXTEEN BIT SELLERS

ST	AMIGA
1943	8.99
A.P.B.	13.99
Altered Beast	13.99
Archipelago	16.99
Archie Collection	N/A
Asteroth Angel	16.99
Balance of Power 1990	16.99
Barbarian (Palace)	8.99
Barbarian 2 (Palace)	16.99
Bank Knight	13.99
Batman the Movie	13.99
Battle Chess	16.99
Battle of Austerlitz	16.99
Beach Volley	16.99
Bionic Commands	6.99
Blade Warrior	16.99
Blood Money	16.99
Bloodwych	16.99
Bloodwych Data Disk	9.99
Bomber	19.99
Cabal	13.99
Captain Blood	1.99
Carrier Command	16.99
Centworld Squares	13.99
Chase Strikes Back	13.99
Chess Player 2150	16.99
Commando	13.99
Conflicts Europe	16.99
Continental Circus	13.99
Cosmic Pirate	8.99
Crazy Cars 2	13.99
Daily Oil Horse Racing	13.99
Damocles	16.99
Danger Freak	N/A
Days of the Pharaoh	16.99
Demons Winter	16.99
Dogs of War	13.99
Dungeon Master	16.99
Dungeon Master Editor	2.99
Dynasty Dux	16.99
Effe	16.99
F-16 Combat Pilot	16.99
F29 Retaliator	19.99
Faery Tale	N/A
Falcon Mission Disc	13.99
Fast Lane	13.99
Fed of Free Traders	16.99
Formula	16.99
French Freddy's Big Top	16.99
Fun of Fun	16.99
Fighting Soccer	16.99
Fire Brigade	2.99
[1 Meg Amiga]	N/A
Foundation Waste	6.99
Football Director 2	6.99
Footballer of Year 2	13.99
Football Manager 2	13.99
Football Manager 2	13.99
Expansion Kit	8.99
Forgotten Worlds	13.99
Future Wars	16.99
Gauntlet 2	N/A
Ghosts and Goblins	16.99
Godrunner	N/A
Godrunner 2	6.99
Grid Iron	16.99
Gunship	16.99
Hilstar	16.99
Hollywood Poker Pro	13.99
Honda RVF 750	16.99
Indiana Jones Last Crusade	13.99
Indiana Jones the Adventure	13.99
It Came From the Desert	N/A
(1 meg only)	N/A
Infection	16.99
Ivanhoe	13.99
Keep the Thief	N/A
Kennedy Approach	16.99
Kenny Diagonal	13.99
Kick Off	13.99
Knightrise	16.99
Last Ninja 2	16.99
Lazer Squad	13.99
L.E.D. Storm	N/A
Leaderboard Collection	13.99
LeisureLut Larry Look For Love	19.99
License to Kill	13.99
Livelibol	N/A
Lombard R.A.C. Rally	16.99
Lords of the Rising Sun	N/A
Marble Madness	6.99
Microprose Soccer	16.99
Milennium 2 2	16.99
Moonwalker	16.99
New Zealand Story	13.99
North and South	16.99
Oil Emponum	13.99
Omega	19.99
Onslaught	16.99
Operation Wolf	13.99
Ostron	6.99
Paperboy	13.99
Passing Shot	16.99

Paul Gascone Super Soccer	16.99	13.99
Phobia	N/A	9.99
Populous	16.99	16.99
Populus New Worlds	6.99	6.99
Powerdrift	16.99	16.99
Pro Tennis	16.99	16.99
Quarterback	13.99	13.99
Quartz	13.99	13.99
Rambo 3	9.99	N/A
Realm of the Trois	9.99	9.99
Red Lightning	19.99	19.99
Red Storm Rising	16.99	16.99
Rick Dangerous	16.99	16.99
Roadwar	6.99	6.99
Robocop	13.99	16.99
Rocket Ranger	16.99	16.99
Running Man	16.99	16.99
Shadow of the Beast	N/A	24.99
Shinobi	13.99	13.99
Shoot 'Em Up	N/A	19.99
Shuffleback Cafe	13.99	13.99
Space Ace	29.99	29.99
Space Quest 3	N/A	16.99
Starliner 2	16.99	16.99
Starwars Trilogy	16.99	16.99
Strider	13.99	13.99
Strix	13.99	13.99
Stunt Car	16.99	16.99
Super League Soccer	16.99	16.99
Super Wonder Boy	16.99	16.99
Sword of Sodan	N/A	16.99



FREE CRACKS FREE HACKS ? - YOU WANNA BET ?

**NEW**

For the **1990s**

**HISTORY'S FOR THE TAKING**

**BY MAIL ONLY**

**TOMORROW'S NEWS LIVE**

**PUSH TODAY TO THE MAX**

**BIT-BOP AND DROP**

**MAKE A STAKE IN THE FUTURE!**  
TRADE HIP TIPS ON THE CRACKS AND HACKS, DECKS AND SPECS, NEWS AND VIEWS OF THE NINETIES.

**THE CYBER TIMES**

GET WHITE-HOT !!! BUT STAY DARK.

**YA GET THE MOST BY POST**

Suddenly someone decided it was time to go VIRAL!!!

**WITH KILLER FREE CODE ON DISK ?**

**This is the ultra-tone this is the pace!! PUSH IT TO THE HILT AND CHIP IN TO THE CAPERS.**

The only euro-net on paper

**IT'S SO VIRTUAL!**

**BI-MONTHLY BY MAIL ONLY**  
GET YOUR COPY OF THE **indispensable** insight into next decade's digital delights.  
LAUNCH JAN 1990

**THE CYBER TIMES**  
COMPUTING'S ONLY LOW-DOWN ON THE FUTURE

ISSUE 000 JAN 1990

FREE CRACKS FREE HACKS ? - YOU WANNA BET ?

**WHY THIS MEGA-DECK WILL CARVE UP THE 21ST C**

**HACK THE SATTS**  
SPY SATELLITE SECRETS FROM YOUR PHONE  
**EXCLUSIVE!**  
**THE FIRST KILLER VIRUS DARK JAP PLASMA DECKS**  
THE NEW CYBERPUNK SENSATION  
**BRITAIN'S HIDDEN BULLETIN BOARDS**  
**CRACKING HOT CODE**  
THE GAME THEY THOUGHT WAS ROCK  
**SCI-FI SO FAR**  
**NEURAL BABIES**  
REAR YOUR OWN CHIPS

**DON'T BELIEVE THE HYPE - BELIEVE THE HYPER**

**HIT the DECKS!**

**LASER BLUE WORLDS FOR FREE**

**INSIDE STORIES FROM UNKNOWN CENTERS**

**CUT THE DREAMING AND JACK IN**

**EVERYONE JUST GOT TO BE FUTURE-PROOF**

**YOU STILL HAVE A CHANCE TO SUBSCRIBE TO THE ONLY SERIOUS GUIDE TO THE UNBELIEVABLE**

**THE CYBER TIMES** invaluable information resource is only available using this coupon. So why not subscribe to the Indescribable ? This fact-packed white-hot newszine will cost you only £3. Better still, get six limited edition bi-monthly issues for the price of five by sending £15 to : **THE CYBER TIMES**, 90A Devonshire Road, Forest Hill, London SE23 3SX

NAME.....  
ADDRESS.....  
.....  
.....POSTCODE.....

I enclose a P.O./cheque for £3  for £15  Get it to me!

**TAP IN TO THE TIMES**

A CLUB FOR THE **ARTIFICIALLY INTELLIGENT**

**Making the GREY BLACK and**

**GLOSS WITH NO GLOSS**

**FORGET THE PRESENT TAKE OUT THE TIMES TOMORROW'S UNDERGROUND TODAY**

**CD-I-CD-V-CD-ROM-CD-RAM-CD-ER**



# ACE READERS PAGES

## FOR SALE

SEGA, 17 Games, light phaser and games. Rapid fire unit, 2 joysticks and joy pad all boxed VGC £250 ono. tel. Jason 021-4217159

SPECTRUM +3, multiformat 3, Epsom FX80 printer, tasword +3, 20+ disks, 60+ games, leads, manuals, £350. RING 01-651-3778.

SEGA MASTER SYSTEM with light gun, control pads, 4 great games including Afterburner, Outrun. All boxed. £100. RING Slough 655742.

RAM UPGRADE ATARI ST. 16x256K chips makes 520 A1040. Can help with fitting cost £99 sell £50. Tel 01-607-7670.

COMMODORE 1541-2 disk drive 128 compatible fully boxed under year old, many games, many extras. Ring 0222 843057. £150.

ATARI ST with loads of games, joystick, mouse and disk boxes, in mint condition only 6 months old. £300. Also included loads of computer mags (ACE's). Tel: 01-428-2393 after 4pm.

SEGA plus light phaser and 12 games worth £300, sell for £140. Tel: 0767 80364 after 6pm.

FREE ST PD! Original boxed software £2-£8. Free monthly disk mag. ST contacts worldwide wanted 05438 4102 after 6pm.

ST GAMES: Populous, Beyond Zork, Trinity, Wishbringer, Lurking Horror. All boxed originals £30 the lot. Tel: 01-449-6232 evenings and w/ends.

ST NEWS the new fanzine for the Atari ST. Only 50p. Send to Stephen Ringrose,

10 Hobart Walk, St Albans, Herts.

AMSTRAD CPC 6128 colour monitor maestro stereo sound amplifying multi face +. Many rave games, Disks, tape deck £350ono. Tel: 07918 6604.

A500 1MEG 1084S monitor over £400 software + lots more, all this for only £550 contact Adam on 0460 72178.

AMSTRAD 6128 built in Disk drive colour monitor tape £400 software and disk box all for £350. Tel: 0408 317640

PC ENGINE plus £200 of software sell for £250 or swap for Amiga. Write to, 22 White Lock Rd, Abingdon, Oxford.

AMSTRAD CPC 6128, colour monitor, joystick, cassette recorder, loads of games, amx mouse. £200 contact Aiden 01-263-7409 after six all days.

PC ENGINE, five games R-type, dungeon, explorer, Galaga 88, Alien Crush, Space Harrier. PAL version worth £410 sell £220. Tel: 0222 628722.

SEGA SYSTEM, £220 worth of games, including Phantasy Star, Wonder Boy 2, Rastan, Thunderblade, sell for £180. Tel: 0908 583318 after 7pm.

VIDEO CAMERA panasonic 1410 B/W as new, with lens £50. Tel: Dave 0617980456.

SPECTRUM +48K excellent condition kempston, joystick, 30+ games including R-type forgotten worlds £99. Lorenzo, Fulham, London. 731-1268

AMSTRAD CPC 464 Green

screen, MP2 modulator, 62 games, joystick, 9 months old. Cost £350 (sell for £150). Tel evenings only on 01-659-7737.

For sale AMSTRAD CPC 464 Computer + TU Modulator + 2 joysticks 74 games 13 blank tapes the lot for £400. Ring Tony on 01-868-7464.

SEGA MASTERS + light phaser 2 new games superb condition still boxed sensible offers. Tel: 01-575-3651.

ACE issues 19-25 £1 each, CPC disks from £1, albums £2 SAE to: 73 Jubilee Rd, New Tredgar, Gwent, NP2 6PD.

A1000 spares only MPS801 premier and disk software, Amiga games £7 each deluxe video 1-2. Tel: 0902-723676.

CPC 464 with MP11 modulator, green screen, 3 joysticks 100+ games inc. Recent releases still under warranty. £160ono.

AMIGA PD, from £1. Send to AAPD, Amberley, Park Drive, Little Aston, Park, Sutton Coldfield 374 2YA

SEGA for sale, 15 games, joysticks worth £400. Sell for about £150. Ring: 0689-49899

C64 disk drive £300 games, C2N, disks, freeze machine, worth £600 + £200. No offers. Tel: 07333-43359 after 6pm.

AMIGA 500 1 meg memory 2nd £1000 of software joysticks, ect. £700ono. Tel: Anoy 0582-582177 (Luton)

ARCADE MACHINES. Full size. Scramble £150, Asteroids £200, Defender £250, bubbles £350. Others. Also some circuit

boards. Steve (0865) 63744

C64's C2ono, quickshot, 25 games, power unit, with Dragon Ninja. Can sell separate or all together. Open to offers. Tel: 804-1358 ask for Juned.

OLIVETTI portable PC M15 with case, manuals, software £500 ono. Tel: 032946817.

SEGA games, excellent titles, Thunderblade, Phantasy Star, After Burner and many more £10 each. Tel: Peter 0684 310191.

SEGA M/S Gun joystick also 31 games titles like Rastan Vigilant worth £850 sell £450. Tel: C.Langford, Walsall 38038 - leave number.

COMMODORE 64, printer, mode, joystick, games, books, wordproc., database, spread sheet. Tue works £300 tel 01-841-8928.

SEGA MASTER SYSTEM for sale £95 +3 games, excellent conditional boxes. Ring office hours 0272 855135 after 6.30pm or 0990 26665.

PC ENGINE games for sale or will swap for others. I have 9 top games on offer. Tel: 01-373-7567

LOOK! AMSTRAD CPC 464, with modulator, joysticks, over 100 games worth £350, sell for £200! Tel: 01-311-2036. after 5pm.

SPECTRUM +3 and CBM 64 for sale all relevant items included plus Multiface 3 The lot £220. Tel: Trevor 071-703-2538.

AMIGA A500 1 year old. In excellent condition, 2 joysticks, mouse, games, diskbox. Price £350. Tel: Adrian: 021-355-7926.

C64, 2xDATASETS,

copiers, 100+ games, lots of mags and books worth over £1000, sell for only £200 - BARGAIN!! Tel: Simon on 0494 721918.

AMSTRAD CPC games. 100+ original titles, some recent. With all documented and in VGC. Tel: 0793 693068 for posted list.

PD it's here!! The Ultimate PD library 75p ST send SAE now!! to 21 Reem Crescent, Heamoor, Penzance, Cornwall. TR18 3HW.

SEX!! (not really) COMMODORE plus 40 games. Lightpen, Joystick, 1520 printer/plotter £150ono. Tel: 0837 840237

AMSTRAD CPC6128, colour monitor, tape deck, leads 100 games, everything together worth £1200. Sell for £450. Tel: Peter 01-458-8681

MODEM (DATACHAT) brand new never used £50. ALSO chitchat Combo plus interface for AMSTRAD £50ono. Tel: 0536 81296

ATARI STFM. Excellent condition over £500 of software inc: TV sports and speedball only £330. Tel: 0408 21440

SEGA MASTER SYSTEM, 2 control pads control stick light phaser, 8 top games Sega T shirt all boxed worth £315 sell £180 Tel: 803 9085

ATARI STFM word processor mouse joysticks art package £500 software, licence to kill, Robocop, Kickoff, Police Quest 2, £350. 0206 222113.

ATARI 520 STFM inc mouse/joystick Ex-condition plus over £500 of games. £270ono. Tel: 0483 276737 after 7pm.

AMSTRAD 464 MONO, joystick, speech synth,

£550 software, worth £850 sell £350. Also modem and interface £110 ring 0326 319505.

AMSTRAD CPC 464, colour monitor, joysticks, speech synthesiser, 80 games, worth £600 when new. Going for £250ono. Please tel Mark 01-659-1337. Evenings.

C128 + 1571 disk drive + 1101 printer + 115 games + sound sampler + joysticks + C2N + Modem and many extras. Total cost nearly £2000 want £300. No offers Phone 0206 540694. All still boxed.

AMSTRAD CPC6128, Green monitor, colour modulator, NLQ printer/typewriter, modem, serial interface, wordstar, supercalc games. £300. Tel: 0463 235972.

AMIGA GAMES, all boxed. 11 Great games inc: Populous, Red Heat, Silkworm, Kickoff. Tel: Mark on Rayleigh 781096 after 6pm. £10 each.

BARGAIN AMSTRAD CPC6128 with colour monitor joystick and over £200 of Software for only £450. Tel: 0543 491554.

SEGA SYSTEM, light phaser Rambo plus 9 other games. £218. Tel: 0978 36022.

ATARI STFM 1MEG DSDD, joysticks, NM-cable, under 1 year old, £650 + software, inc; Falcon, Jet Stos, Dungeon Master Only £325. Tel: 01-861-2642. Evenings.

CPC 6128 colour, tape deck, games worth over £300 clock radio, TV modulator all for £425.

CPC 464 colour business and games joystick books mags. Tel: Ian 0727 62879 £175ono.

AMSTRAD CPC464 with green monitor, joystick,



modulator and games selling for £150. Tel: 01-672-8993 ask for Kingsley.

ATARI ST originals, £3 each more than 150 games. Like to buy/swap also. Write to PO Box 76, 2995ZJ, Heerjansdam, Holland.

COMMODORE 64, Data cassette, mouse, joysticks £700 worth of software excellent condition worth £1000 + books, manuals boxed £250 ono. Tel: Chris 051-632-5413.

AMSTRAD CPC464, colour monitor, speech synthesiser, joysticks over £160 games, Dust covers, 58 mags, tutorial kit, £300 (0892) 38484

C64 + 1541 Disk drive Datacorder loads of software 58 tapes, 12 disks a bargain £210. Tel: 0925 837597 - Warrington.

GAME BUSTERS over 26 A4 sides of 200 + pokes, maps, cheats for £2.50 p+p inc or 100 + for £1.50 cheques/POs to S. Clarke, 25 South Rd, Saffron Walden, Essex. CB11 3D6.

ATARI ST, Amstrad 464, Horse predictor, September Produced 46.61% winners, Profit £89.16. Send £7.50 or £5 + Disk/tape. 400 games under £5 each, send SAE + £1 for giant price list. A Tranter, 350 Wigan Rd, Leigh, Lancs. WN7 5HR. 0942 260017

C64 cassette disk drive over 100 games £135 also Sega system 12 games £115. Tel: 097-883-5638.

ATARI ST games for sale or swap. Send SAE to James Melville, 12 Davidson Rd, Jamestown,

Dunbartonshire. G83 8AY. SEGA MEGADRIVE for sale one month old hardly used £170ono. Tel: 061-747-6442.

CBM 64 War games SS1, many titles from £5-10 a boxes as new. Tel: Phil, 0909 563536.

ATARI 520 STFM ex condition. 2 joysticks + mouse + £450 of great games + mags. Very good for starters. Tel: 8705891 £299.

SEGA CONSOLE, + joystick sell for £100ono. Games inc: Double Dragon, Thunderblade, Golvellius, Altered Beast, zillion 2. Tel: Jim on 0256 51763.

C64 DATA cassette, joystick, freeze frame cartridge, £500 of Software, all for only £300. Tel: James on 0727 60636.

ORIGINALS for ATARI ST, UMS, R-TYPE, Thunderblade., Pacland, Barbarian (Psygnosis), Lurking Horror, Robocop, LS Larryl, £12 each, £70 bundle. Contact James 0889 564554- After 6pm.

SEGA GAMES to SWAP!! I have 12 Sega cartridges to swap - If you are interested. Tel: 0249-76-629 after 6pm.

AMSTRAD CPC 464 MONO monitor, good condition, £300 serious and games software, joysticks, mags, worth £500, sell for £165ono. Tel: Paul 051-426-9443.

AMIGA A500 still boxed, with loads of games, populous, Falcon ect.. Also joystick, manuals, Bargain £270. Tel: Simon 0242 570809 after 6pm.

SPECTRUM 128K good condition over 100 games

wil sell about £100 Tel: 01-785-9154. Ask for Robert.

AMSTRAD GAMES and accessories includes games (R-TYPE, Arkanoid), Demos, (ocean), Mags, Joysticks, and more ringTim on 0636 701094

sell for 80 includes p+p. ST + AMIGA contacts wanted especially newcomers to the St+Amiga 101% reply, large collection, don't delay, send stamp! Write to D. 3 Mossling East, Kilbride, G75 OHH

send to : Julian, 7 Cowray Close, L'sPa, WARKS. CV31 1LB.

AMIGA CONTACTS wanted send lists ect..to Jez. 5 Crestholme Close, Knaresboro, North Yorkshire. HG5 OSR. 100% reply.

ATARI ST coontacts wanted. Swap hints, tips ect..100% reply. Write to Ian Red Lion, Brill, Bucks. HP18 9RT.

AMIGA CONTACTS wanted to swap latest stuff. Write to Skyfire, 27 New Penkridge Rd, Fannock, Staffs. WS11 1HW.

AMIGA CONTACTS wanted all over the world. Write to Jussi Kiho, Kemia-kato, 13 E 40 33720, Tampere, Finland.

AMIGA CONTACTS wanted 100% reply contact N. Crowwaite, 40 Westmorland Drive, Brinnington, Stockport, Cheshire. SH5 8HH.

PENPAL. SEGA owner with 16 games wantsa penpal to swap games and tips. Write to: Nathan Wilkins, Ivy House, New Zealand, Hilmarton, Calne, Wilts.

## PENPALS

AMIGA CONTACTS wanted to swap latest stuff send disks or lists to 73 Whitesides Hill, Portadown, c/o Armaey, Northern Ireland.

AMIGA CONTACTS wanted 100% reply. Send lists to: Richard, 31 York Rd, Douglas, I.O.M., U.K. WORLD.

IBM PC contacts wanted from all over the world!!! Write to JOOS B Fr. Broeckartin.77, 92800vermere, Belgium.

AMIGA AND APPLE MAC 2 contacts wanted to exchange ideas etc. DTP especially. John, 5 Cross Lane, Huthwaite, Notts. NG17 2JJ

ATARI ST PENPALS WANTED. Exchange hints, tips. 100% reply. Write to Brian Irwin, 3 Raphoe Rd, Crumlin, Dublin 12, Ireland.

AMIGA contacts wanted all over the world, all letters replied by quick air mail. Write to Peter, 68 Gray St, Carina 4152, Brisbane, Queensland, Australia.

AMIGA contacts wanted - anyone 100% reply. Write to: Ian, 123 Corby Rd, Weldon, Corby, Northants NN17 3HU. Hurry up!!

C-64 contacts wanted, write to: Peik Stromsholm, Beach Street 30, Strandgatan 30, SF-VAAG 65120, Finland.

AMIGA CONTACTS wanted.

Tel: Daz on : 0253 593636 after 6pm.

AMIGA ST contacts wanted. Write to James : 37 Brunswick Court, 89 Regency Street, London. SW1P 4AE. or Tel : 01-834-6204.

ST CONTACTS wanted 100% reply write to Steven Laker, 58 Martin Hardie Way, Tolbridge, Kent. TN10 4AE.

AMIGA CONTACTS wanted for latest stuff. 101% reply. Send lists/disks to Nik, 16 Admiralty Rd, St.Budeaux, Plymouth, Devon. PL5 1NJ.

AMIGA CONTACTS wanted, swap software write or phone Mark 1 Ashmeads Way, Colehill, Wimbourne, Dorset. Tel: 0202 884561

AMIGA CONTACTS wanted 100% reply, contact Mark 24, Finsbury Ave, Sileby, Leicestershire LE12 7PJ. Tel: 0509 812045

AMIGA CONTACTS wanted, 100% reply guaranteed. Fast and reliable contacts only. Write to Dal, 83 Gainsborough Rd, Knighton, Leicester. LE2 3DH

AMIGA CONTACTS wanted from anywhere in the world. Guaranteed 101% replies. Write to John, 1 Ivor Rd, Corfe mullen, Wimbourne, Dorset, England. BH21 3QF.

SEGA CONTACTS wanted to swap games and ideas

## MISCELLANEOUS

SOFTWARE EXCHANGE, swap your used programs, free membership. Swaps from £1.45 Atari St, Amiga SSAE to R.P.Day, 15 Tunwell Greave, Sheffield. S59 9GB.

SWAP PC software and VHS films. Write to : PPC/2, P.O.Box 131, 78201 varkaus, Finland.

Wanted 9/24 pin dot matrix printer for ATARI ST. Contact : M.Mackay, 4 Chestnut Grove, Wavertree, Liverpool.

L15 8HS. Tel : 051-734-3450.

EARN £50-£250 weekly at home in your spare time. Send SSAE: David Chmylow, 31 Monk Mains Rd, Haddington, East Lothian, EH414NA.

Want to be rich? Find out how! SAE to: A.Ralph, 39 Holling Bury Rise, Brighton, Sussex. BN1 7HH.

CAN'T SLEEP. Zak Mckracken bending my mind. Please send help. Tel: 0543 54647

Europe's Largest Stock of Video Games & Cartridges For —

**TELEGAMES**

COLECO VISION™ INTELLIVISION Nintendo PC Engine SEGA SEGA MEGA DRIVE NINTENDO GAMEBOY ATARI 2600 and 7800

The leading Video game specialists. Send for lists (state make of game) **TELEGAMES, WIGSTON, LEICESTER, LE8 1TE. (0533-880445)**



# BRUCE LEE LIVES!

To celebrate the launch of its new *Bruce Lee Lives* computer game, Mindscape is generously giving away...

**THE COMPLETE COLLECTION OF BRUCE LEE VHS VIDEOS  
(INCLUDING WAY OF THE DRAGON, ENTER THE DRAGON AND FIST OF FURY)  
AND A COPY OF BRUCE LEE LIVES COMPUTER GAME**

**PLUS**

**10 COPIES OF BRUCE LEE LIVES COMPUTER GAME**

**THE GAME**

The master of the martial arts, that lethal legend, the king of kung-fu, BRUCE LEE IS BACK. Mindscape/Software Toolworks latest game, *Bruce Lee Lives* (reviewed on page 49), "the final martial arts adventure" allows you - through practice and battle - to become Bruce Lee, master of jeet kune do, Bruce's own deadly form of martial arts.

Among the new features found in the game are opponent Artificial Intelligence and a control

macro facility. The unique use of AI lets your enemies memorise your technique and counter-attack... move-for-move! To win each brutal match, you must constantly alter and rework your fighting method. The programmable macro control facility lets you choreograph any series of fighting moves - punches, jabs, kicks, etc - and assign them all to one control trigger.

"You don't just play Bruce Lee Lives - you enter it!"

**WHAT YOU HAVE TO DO...**

To win these fabulous Bruce Lee prizes just answer the following question:

- 1 Who isn't a movie martial arts star?  
(a) Bruce Lee (b) Chuck Norris (c) Gary Williams

Write the answer on the back of a postcard and give us a gameplaying tip on your favourite computer, console or coin-op game... Have you found a hidden cheat mode or secret level? Perhaps a

poke for peek performance? How about a well tested tactic to tackle tense times?

Don't forget to include your full name, address, telephone number and computer format.

Send your entry to:

BRUCE LEE LIVES!  
Pink Page Competition,  
ACE, Priory Court, 30-32 Farringdon Lane,  
London EC1R 3AU.

Closing date for entries is 7th January, 1990. The first correct entry drawn at random from the entries received prior to the closing date will win the videos and a copy of the game. The next 10 entries drawn will each win a copy of the game.

Please note: employees of EMAP, Mindscape and Software Toolworks are not eligible for entry. The editors decision is final and no correspondence will be entered into.

## SUBSCRIBE!

Get 13 issues of ACE for the price of 12 - and get it delivered to you in the comfort of your own home

### HOW TO ORDER

Complete the coupon below OR send your details on plain paper OR ring our special 24 hour Orderline service on 0858 410088 and quote your credit card number.

### ANNUAL RATES

UK	£17.95
Overseas Surface Mail	£27.95
Airmail Europe	£42.95

We suggest that overseas readers pay by International Money Order. Other airmail rates available on request. For subscription enquiries telephone 0733 555161

**To ACE Subscriptions Dept., PO Box 500, Leicester LE 99 0AA**

Name .....

Address .....

Postcode .....

Please start my subscription from the (enter month) .....

issue of ACE. I enclose my cheque/postal order for £ ..... (payable to ACE magazine

Please charge £ ..... to my Access/Visa/Diners/AmEx account. Card number ..... Expiry Date .....

Signature .....



# READERS PAGES: HOW TO PLACE YOUR ENTRY

All you have to do is send off the form below, together with your payment; Entries to the Pink Pages cost just £4.00 each. (Except for Helpline, which is free).

- The maximum is 20 words except for Helpline. (Helpline entries can be extended to 100 words max – use another sheet of paper if necessary).
- The service is NOT open to trade advertisers.
- We will print your advertisement in the first available issue.
- Entries which could be interpreted as encouraging software piracy will not be accepted.

## ENTRY FORM

POST TO: **Ace Readers Page,**  
**Emap B&CP, Priory Court,**  
**30-32 Farringdon Lane,**  
**London EC1R 3AU.**

Please place my ad in the next available issue of ACE.

Name:.....

Address:.....

.....

.....

Category of entry:

- Helpline
- For Sale
- Wanted
- Pen Pals
- User Groups
- Other

Write your advertisement here, one word per box. Include your name, address and phone number if you want them printed.

Method of Payment

- Cheque
- P.O.

Please make cheques and postal orders payable to

**ACE MAGAZINE.**

## ADVERTISERS INDEX

Activision.....12/13	Logotron.....108	Silica.....119,125
Atari.....53,101	Mirrorsoft.....22,48,96	Serv-U.....139
Anco.....29	Microprose.....25,38,86,	Software City.....156
Alternative.....64	.....90,106,107	SDC.....144
Bondwell.....130	Mindscape (IBC).....71	Shekana.....152
Computer Ad World.....141	Megaland.....134,135	SE Kent.....154
Cyber Times.....157	MCD.....146,147	System 3.....16
Domark.....8,57	Mention Tech.....148,149	Tynesoft.....122
Dialcom.....93	Mailcenta.....155	TC Computers.....154
Evesham.....132	Medusa.....154	Telegames.....159
Electronic Arts.....11,51	Ocean (OBC).....6,7,26,43	US Gold (IFC).....63,66,
Future.....128,129	.....54,59,76	.....67,102,103
Gremlin.....85	Prism.....111	UBI Soft.....60
Infogrames.....75,117	Psygonsis.....18,44,89	Virgin.....21,30,82,83
Intermediates.....143	Rainbow Arts.....36,37	Worldwide.....153
	.....78,98,112	
	Rapid.....136	



# The BLITTER END

## XMAS SILLY SEASON STARTS HERE!

It's been a strange month for the ACE team... Garry 'Wodge' Williams is off the booze, Rik 'Hitman' Haynes said he couldn't stand another drink either, and Jim 'Who's that girl' Willis hasn't made a move on a girlie all month! How are they going to cope with the Christmas Party Season? And to top it off, Steve 'Could I borrow 20p' Cooke has disappeared into the Bermuda triangle - and he didn't even leave me a Christmas present!

### In-love with Lovecraft?

Did you like the illustration of HP Lovecraft in last month's ACE (issue 27, page 37)? If the answer is yes, you'd be pleased to know you can get this classy HP Lovecraft Centenary design on T-Shirt (Sizes: Large and Extra Large £7.95), Limited Edition Print (Only 100 copies, signed and numbered by the artist £3.50) or Signed Edition Print (£2). Please make cheques/PO's payable to D.C. Designs (all UK orders post free). Order from: Dave Carson, Flat 10, Block J, Peabody Estate, Horseferry Road, London SW1P 2EN. DC Designs also does personalised designs, send SAE with your enquiries.

### Atari Lynx Competition

The closing date for the Atari Lynx competition (further details ACE issue 27, page 121) has been extended to 7th January, 1990.

### ZZZ... ZZZ... ZZZ...

And the award for this month's most boring press release goes to... cue loud fits of snor-

### ACE TOP TITLES

#### Laurence

- 1 Interphase • Image Works
- 2 Stormlord • Hewson
- 3 Tetris • Nintendo Gameboy
- 4 Rock 'n' Roll • Rainbow Arts
- 5 Myth • System 3

#### Rik

- 1 Kick Off • Anco
- 2 Tetris • Nintendo Gameboy
- 3 Battle of Britain • Lucasfilm
- 4 Hard Drivin' • Domark
- 5 Battle Squadron • Electronic Zoo

#### Steve

- Leisure Suit Larry 3 • Sierra-on-Line

#### Jim

- Crystal Quest • Mac

#### Eugene

- 1 Tetris • Nintendo Gameboy
- 2 Ghouls 'n' Ghosts • Capcom
- 3 Damocles • Novagen
- 4 Big Run • Jaleco
- 5 X-Multiply • Irem

#### Gary

- 1 Tetris • Nintendo Gameboy
- 2 Kick Off • Anco
- 3 Cloud Master • Sega

ing... Amiga Centre Scotland for its Multiport Board press release. I quote: "From CMI, this two serial, one parallel, and optional SCSI port expansion device comes complete with built-in high-speed serial networking support. It features 2 Serial Ports (DB9 RS-232 and 8 pin mini DIN RS-422), 1 DB25 parallel printer port, optional SCSI hard drive interface, and full CMI, net-AppleTalk compatible hardware. Barry Walsh, development consultant, said "it dramatically expands the Amiga's I/O capabilities. This opens up so many possibilities for Amiga expansion that we know people have been waiting for".

Well, I'm sure you agree, it's pretty exciting stuff, eh? But if low level SCSI format supports aren't among your most desired possessions, you can always check out next month's ACE for the latest games news, views, reviews, previews, interviews and other words that don't end in ws. But for now, avior and have a very merry Christmas.

Blit-Blit!

### NEXT MONTH

In the next all action issue of ACE we take an in-depth look at computer footie games (including the greatest football game to date... Anco's *Kick Off*), interview Oscar-winning graphics wizard John Lasseter, talk to The Twits - Domark's lively bosses, give you music maestros the complete buyers guide to MIDI, life and everything, plus much more...

ACE 29 goes out for sale Thursday 4th January, 1990.

### CRAZY CAPTION COMPETITION

Don't do it Richard, being a millionaire and multimedia personality can't be that bad! Whether or not you gun for Richard Branson, you could get your grubby little mitts on a copy of Virgin/Mastertronic's latest game for your computer. All you have to do is give us a caption for the pic and a games tip for your favourite coin-op, console or computer game. The pic was taken at a recent press party (ACE was there in full force) to launch the Sega Challenge games championships. The winning entry will be chosen by panel of well informed, sensible and extremely unbiased judges - that let's out most of the legal system I here you cry - but fear not because it's a panel of just one, i.e. me! The winner will be the person with either the funniest, most boring or totally insane caption. Send your entries (with attached crisp £5 note!?) to: VIRGIN ON THE RIDICULOUS, Blitter End Competition, ACE, Priority Court, 30-32 Farringdon Lane, London EC1R 3AU. Don't forget the games tip, and include your full name, address and computer model. Entries must reach us by 7th January, 1990.





# You are Captain Kirk!

You are Captain T Kirk, the Enterprise is yours and your mission is to drop off three intergalactic ambassadors on a safe planet, without starting a war. You can interact freely with your crew - Spock, Scotty and the usual team are there, but you are pitted against the remorseless aggression of K'laa and the Klingons, and you have to escape from the deadly Barrier Zone.

The revolutionary graphics create the most realistic game ever. The play of Star Trek V changes to suit the challenge at hand. The strategy and action is your responsibility. Not only do you have to deal with outside forces, but all is not well within the Starship. Just how good a Captain are you?

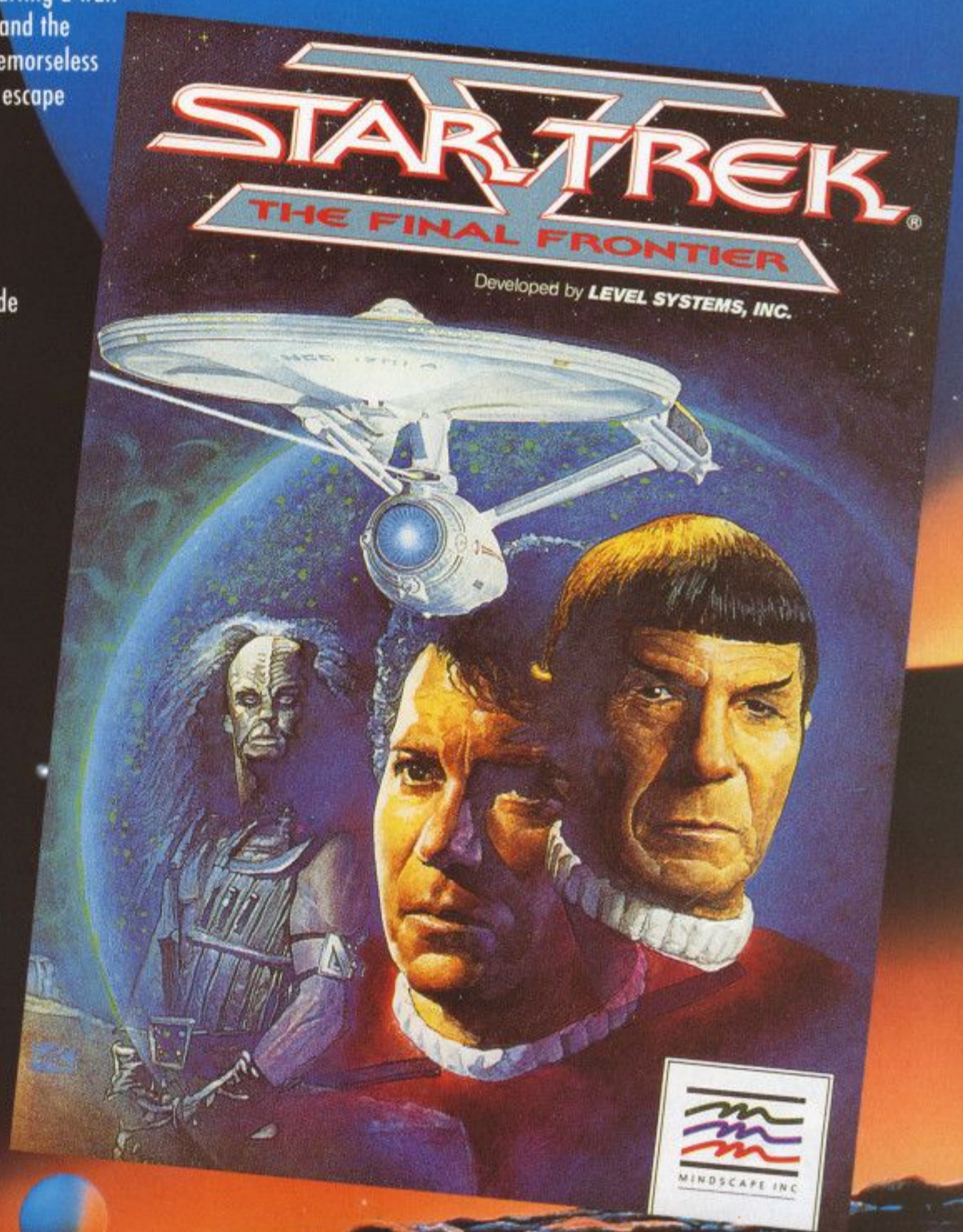

Actual IBM screen



Available for Amiga, Macintosh, IBM, Tandy and compatibles.

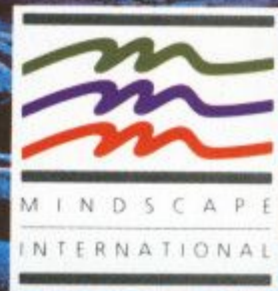

# M I N D S C A P E

For further information on Mindscape products and your local Dealer, contact:  
Mindscape International Limited, PO Box 1019, Lewes, East Sussex BN8 4DW. Tel. (044 486) 545/547.



# THE UNTOUCHABLES™

## THE ULTIMATE

six exciting action sequences  
put you in control of Elliot Ness's  
elite squad of mafia-busters.

## ALLEYWAY SHOOTOUTS

### THE BORDER RAID

The Railway Station confrontation and  
Warehouse bust culminating in the thrilling  
denouement of a

## ROOFTOP DUEL

as you re-live the knife edge existence of Ness  
in his struggle against the retribution of Capone!

THE  
**UNTOUCHABLES**  
LIVE AN AMERICAN LEGEND



"a fine example of how to do the job  
properly ... a cracking conversion ...  
easily one of the most successful  
licences to date"  
Sinclair User

"an absolute corker of a game ... as  
smooth and polished as you can get,  
animation is top notch ... a brilliant  
film conversion"  
Your Sinclair



# ocean

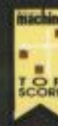

TM & Copyright © 1987  
by Paramount Pictures  
Corporation.  
All Rights Reserved.

SPECTRUM  
COMMODORE  
AMSTRAD

**£9.99**

ATARIST  
PC & COMPATIBLES

**£19.99**

AMIGA

**£24.99**

"Apart from the sheer thought  
apparent in the game design, there  
are the superb graphics"  
Games Machine

"the film was great ... the game is  
even better. Great atmosphere ... the  
music is brilliant ... a spectacular  
combat game, an unbelievable  
package ... and utterly superb game."  
Zzap